

SCIENCE AND TECHNOLOGY PROGRAMME 2008 - 2017

A programme to
upgrade Europe's
strategic centre
for science and
technology research

VOLUME 1
Parts 1 to 4
September 2007



European Synchrotron Radiation Facility

SCIENCE AND TECHNOLOGY PROGRAMME 2008 - 2017

A programme to
upgrade Europe's
strategic centre
for science and
technology research

VOLUME 1
Parts 1 to 4
September 2007





The European Light Source

SCIENCE AND TECHNOLOGY PROGRAMME 2008-2017

FOREWORD

In December 2008 the European Synchrotron Radiation Facility (ESRF) will celebrate the 20th anniversary of the signature of the Convention between the 12 original Member countries, which launched the construction phase of the ESRF. The ensuing period has been one of invention and innovation, with the ESRF playing a world-leading role in the development of cutting-edge synchrotron X-ray science, so that it is now a reference, not only for research with synchrotron light, but also as an excellent example of European cooperation. The ESRF is an essential component of the evolving European Research Area, underpinning European technology and economic development. The Grenoble international campus, with the ESRF light source and the Institut Laue-Langevin (ILL) neutron source, both identified in the European Strategy Forum on Research Infrastructures (ESFRI) roadmap as being vital infrastructures for European research, is unique in the world and recognised as one of the jewels in the crown of European science. An additional dimension is provided by the European Molecular Biology Laboratory (EMBL) outstation and the many joint life-sciences projects between the ESRF, the EMBL and the ILL.

In line with the recommendations of the ESRF Council and Science Advisory Committee, the ESRF's remarkable electron storage-ring X-ray source and specialised beamlines have been continuously refined, pushing the limits of technology and redefining state-of-the-art performance. As a consequence of this policy, the ESRF is currently operating at extremely high efficiency and productivity; over 4000 scientists visit the ESRF annually to carry out their demanding research projects, resulting in over 1400 refereed publications each year, based on the accelerator complex operating at an availability level of over 98%.

The attractiveness of the ESRF to Europe's scientific community remains undiminished. Between 2000 and 2006 the number of applications for beamtime increased by almost 30%; during this period the ESRF's capacity to satisfy this increased demand remained essentially unchanged. This growth in interest has been accompanied by a significant development of new scientific fields, notably in the environmental and culture heritage sciences. These areas of research, at the interfaces between classical disciplines, are expected to grow rapidly over the next few years. As a result, the incremental approach to accelerator and beamline renewal must now be accompanied by a major step-wise upgrade, a unique opportunity to reconfigure the beamlines to prepare for tomorrow's radically different scientific challenges.

The Council's requirement that the ESRF develop a long-term plan for the next 10 to 20 years has led to the development over the last 4 years of the Long-Term Strategy (http://www.esrf.eu/files/Upgrade/LTS_060706.pdf). This project, in partnership with the User community across Europe and with the essential advice of the SAC, involved identifying key areas of future scientific development, where synchrotron light will make essential and unique contributions. These scientific "highlight fields" are nanoscience and nanotechnology, pump-and-probe experiments and time-resolved science, science at extreme conditions, structural and functional biology and soft matter, and X-ray imaging.

To prepare the ESRF for tomorrow's science a vigorous programme of instrumentation development will be needed, encompassing new detectors, focusing optics and beamline engineering at the nanometre level, and advanced sample environments. Much of this work should be carried out in partnership with our colleagues from the European network of synchrotron sources, centres which complement the ESRF and with which the ESRF enjoys strong scientific and technical links. The comprehensive volume of experience and knowledge gained during the construction and operation of the ESRF will continue to be of great benefit to these new sources, providing an invaluable store of scientific and technical know-how.

Our ambitious Upgrade Programme, the ESRF Scientific Programme 2008 - 2017, is the natural evolution of the scientific challenges described in the Long-Term Strategy document. The following chapters of this volume provide considerable detail on the ESRF's new scientific and technical capabilities. All aspects of the programme are considered, starting with the new science to be enabled by the Upgrade, the technology, engineering and infrastructure requirements and, finally, the budget and personnel implications.

This Upgrade Programme is essential to maintain the ESRF's role as the leading European provider of hard X-ray light, providing answers to essential future scientific questions, and safeguarding the large investment by the Member countries. However the programme cannot be financed from within the ESRF's current investment budget. Of the total cost of 287 million euros spread over 10 years, some 210 million euros of new investment is required; the balance will come from the investment part of the ESRF's standard budget. This additional investment will lead to a radically enhanced ESRF with a suite of very long beamlines capable of focusing to nanometre spot sizes, revolutionary technical infrastructure support, and upgraded high-reliability accelerators providing even higher brilliance and stability. This programme is excellent value for money; a new facility providing similar performance for a large number of specialised beamlines would require investment of the order of 1 to 2 billion euros.

In summary, for a relatively modest investment by the partners of the ESRF, a radically upgraded hard X-ray synchrotron radiation facility will emerge from the 10 year period of renewal, during which the Users will still have access to a large fraction of the beamlines. The renewed and enhanced ESRF will be in excellent shape to face the scientific challenges (environment, energy, health, new materials ...) of the twenty-first century.

W.G. STIRLING
Director General of the ESRF
September 2007



Executive summary

A ten year Upgrade Programme of the European Synchrotron Radiation Facility (ESRF) will greatly enhance its scientific capabilities for new research, to better respond to the problems and needs of modern society.

The ESRF

The ESRF is Europe's international centre for synchrotron radiation based X-ray research (one of three high energy synchrotron sources operational worldwide). Eighteen member states contribute to finance the Facility, which receives over 4,000 academic and industrial scientists annually. Four scientific publications per day are produced based on results obtained here. The Upgrade Programme is necessary to maintain this success, and to open new fields of opportunity.

Scientific case and project context

Science and technology are rapidly advancing towards the nanometre scale, manipulating atoms one by one or in small groups. X-rays are an ideal tool to study nanoobjects, as X-ray wavelengths are perfectly matched to this length scale. The Upgrade will focus on extending the capabilities of the ESRF in five highlight areas:

- Nanoscience and nanotechnology
- Pump-and-probe experiments and time-resolved science
- Science at extreme conditions
- Structural and functional biology and soft matter
- X-ray imaging

The Upgrade Programme will create opportunities for new science at the ESRF by developing the engineering technology, scientific instruments and necessary site infrastructure, all of which will be available to users and collaborators throughout Europe.

Key objectives of the Upgrade

- *Eighteen new and upgraded experimental stations (beamlines) for new and improved science* – with a strong emphasis on nanoscience made possible by the routine delivery of nanosized X-ray beams.

- *Delivery of enabling technologies* – nanocompatible engineering and optics, extended range of extreme environments, vastly improved X-ray detectors and data analysis tools.
- *Enhancement of the X-ray source* – more than doubling the intensity of the X-ray beams with improved stability, and creating additional flexibility for novel, even more efficient uses of the X-ray source.
- *Construction of 21,000 m² of additional space* – for extended nanofocus beamlines and for new support infrastructure.
- *Development of collaborations and partnerships with academia, other synchrotrons, and industry* – ensuring key technologies for the benefit of the broad community.

Project status

An outline of the ESRF Upgrade was enthusiastically received by the ESRF governing bodies in June 2006. The Upgrade Programme is one of thirty-five projects included on the European Strategy Forum on Research Infrastructures (ESFRI) roadmap, which identifies the key new research infrastructures corresponding to the long-term needs of European research communities.

The ESRF has launched pre-project studies of the Upgrade, drawing on its own resources whilst still operating at full capacity. The project is now at a stage where fresh investment is required to allow the project to proceed.

Schedule and estimated cost

The Programme is ready to start in 2008 and will cover ten years. The estimated total investment of 287 M€ breaks down as follows:

- **Capital** 238 M€, of which 77 M€ will be financed from the regular budget
- **Recurrent** 28 M€ in addition to the regular budget
- **Personnel** 21 M€ for additional support staff (30 maximum).

ACKNOWLEDGEMENTS

This report, the "Purple Book", has been written by the staff of the ESRF. The Upgrade Programme Project Group gratefully acknowledges their dedication, endless patience and support. The drafting of so many articles represents a significant effort in addition to the everyday life of the institute, and so we express our deep appreciation to all.

Special recognition goes to Gary Admans and Mary Baldwin for their untiring labour in helping to prepare the report.

Our thanks also go to our external advisors, whose enthusiasm and constructive feedback on the contents have been invaluable.

We now look forward to the implementation of the programme and the innovative ideas that are set out herein.

*Trina Bouvet, Carsten Detlefs,
Edward Mitchell, Jean-Luc Revol*



The European Light Source

SCIENCE AND TECHNOLOGY PROGRAMME 2008-2017

TABLE OF CONTENTS

PARTS 1-2-3-4

| | Page |
|---|-----------|
| INTRODUCTION | 4 |
| PART 1 - SCIENCE AT THE ESRF | 11 |
| <i>Overview to PART 1</i> | <i>13</i> |
| 1.1. SCIENCE AT THE NANOMETRE SCALE | 16 |
| 1.1.1. Introduction | 18 |
| 1.1.2. Single objects at surfaces and interfaces | 19 |
| 1.1.3. Soft condensed matter and biological systems | 24 |
| 1.1.4. Hard materials at the nanometre scale | 26 |
| 1.1.5. A platform for nanoanalysis | 28 |
| <i>References</i> | <i>30</i> |
| 1.2. STRUCTURAL AND FUNCTIONAL BIOLOGY, SOFT MATTER | 32 |
| 1.2.1. Introduction | 34 |
| 1.2.2. Structural and functional biology | 34 |
| 1.2.3. Soft condensed matter: biological applications | 38 |
| 1.2.4. Soft and fragile matter: microstructure, dynamics and out-of-equilibrium phenomena | 42 |
| <i>References</i> | <i>47</i> |
| 1.3. STRUCTURAL PROPERTIES AND CHEMISTRY OF MATERIALS | 50 |
| 1.3.1. Introduction | 52 |
| 1.3.2. Chemical crystallography and structural chemistry | 52 |
| 1.3.3. Fundamental chemical reaction processes | 55 |
| 1.3.4. Matter at extreme pressures and temperatures | 60 |
| 1.3.5. Materials science | 66 |
| <i>References</i> | <i>70</i> |
| 1.4. DYNAMICAL PROPERTIES AND ELECTRONIC STRUCTURE OF MATTER | 72 |
| 1.4.1. Introduction | 74 |
| 1.4.2. Electron correlation and magnetism | 74 |
| 1.4.3. Collective motion of atoms | 79 |
| <i>References</i> | <i>82</i> |
| 1.5. EMERGING SCIENTIFIC APPLICATIONS OF SYNCHROTRON RADIATION | 84 |
| 1.5.1. Introduction | 85 |
| 1.5.2. Clinical and biomedical applications of synchrotron radiation | 86 |
| 1.5.3. Environmental science | 89 |
| 1.5.4. Palaeontology | 93 |
| 1.5.5. Archaeological science and cultural heritage | 96 |
| <i>References</i> | <i>99</i> |

| | |
|--|------------|
| PART 2 - TECHNOLOGY AND ENGINEERING CHALLENGES | 103 |
| <i>Overview to PART 2</i> | <i>105</i> |
| 2.1. BEAMLINE ENGINEERING DEVELOPMENTS | 107 |
| 2.1.1. Introduction | 108 |
| 2.1.2. X-ray optical systems | 108 |
| 2.1.3. Support laboratories | 112 |
| 2.1.4. Test beamlines and mirror surfacing facility | 113 |
| 2.1.5. Beamline control | 113 |
| 2.1.6. Integration | 114 |
| 2.2. TOWARDS NANOSCALE IMAGING | 115 |
| 2.2.1. Introduction | 116 |
| 2.2.2. Towards nanoscale imaging with synchrotron radiation | 116 |
| 2.2.3. Beam steering and sample positioning | 120 |
| <i>References</i> | <i>122</i> |
| 2.3. EXTENDED PUMP-AND-PROBE TECHNIQUES | 123 |
| 2.3.1. Introduction | 124 |
| 2.3.2. Picosecond lasers | 125 |
| 2.3.3. Advanced hybrid filling patterns for the storage ring | 125 |
| 2.3.4. Future insertion devices and beamline optics | 125 |
| 2.3.5. Time-resolved 2D detectors | 125 |
| 2.3.6. Time-resolved X-ray absorption and emission spectroscopy using pump-and-probe | 126 |
| 2.3.7. Pump-and-probe studies of magnetisation dynamics with circularly-polarised X-rays | 127 |
| <i>References</i> | <i>127</i> |
| 2.4. ADVANCED SAMPLE ENVIRONMENTS AND EXTREME CONDITIONS | 128 |
| 2.4.1. Introduction | 129 |
| 2.4.2. High-pressure technology | 129 |
| 2.4.3. High- and low-temperature environments | 131 |
| 2.4.4. Other developments | 132 |
| 2.4.5. High magnetic fields | 133 |
| <i>References</i> | <i>139</i> |
| 2.5. X-RAY DETECTOR DEVELOPMENTS | 140 |
| 2.5.1. Introduction: the detector handicap | 141 |
| 2.5.2. High-sensitivity large-area detectors | 143 |
| 2.5.3. High-efficiency sensors | 145 |
| 2.5.4. Fast imaging cameras | 146 |
| 2.5.5. Time-resolved hybrid pixel counting detectors | 147 |
| 2.5.6. Pixel detectors with extended dynamic range | 149 |
| 2.5.7. Energy dispersive 2D detectors | 151 |
| 2.5.8. Specific detector programmes | 152 |
| <i>References</i> | <i>154</i> |
| PART 3 - INFRASTRUCTURE TO ENABLE NEW SCIENCE | 157 |
| <i>Overview to PART 3</i> | <i>159</i> |
| 3.1. ACCELERATOR AND SOURCE DEVELOPMENTS | 160 |
| 3.1.1. Introduction | 161 |
| 3.1.2. 7 m Long insertion device straight sections | 162 |
| 3.1.3. Increased ring current and RF upgrade | 164 |
| 3.1.4. Top-up operation | 168 |
| 3.1.5. Lowering the vertical emittance | 168 |
| 3.1.6. Other developments | 169 |
| 3.1.7. Short bunches: production of ultra short X-ray pulses | 169 |

| | | |
|---|---|--------------|
| 3.1.8. | The future beyond the ESRF Upgrade | 169 |
| | <i>References</i> | 170 |
| 3.2. | BUILDINGS AND INFRASTRUCTURE EXTENSIONS | 171 |
| 3.2.1. | Introduction | 172 |
| 3.2.2. | Creating new space | 173 |
| 3.2.3. | Technical considerations and constraints | 177 |
| 3.3. | COMPUTING CHALLENGES | 180 |
| 3.3.1. | Introduction | 181 |
| 3.3.2. | Online data analysis | 181 |
| 3.3.3. | Software for scientific computing and off-line data analysis | 184 |
| 3.3.4. | Scientific data handling and curation | 188 |
| 3.3.5. | Accelerator and beamline control system | 188 |
| 3.3.6. | Scientific management information system | 189 |
| 3.3.7. | eScience and Grid | 190 |
| 3.3.8. | Computing infrastructure | 191 |
| 3.3.9. | Collaboration and European projects | 194 |
| | <i>References</i> | 194 |
| PART 4 - COST, STAFF AND SCHEDULE | | 197 |
| 4.1. | COST AND ADDITIONAL STAFFING | 199 |
| 4.1.1. | Introduction | 199 |
| 4.1.2. | Infrastructure capital investment | 199 |
| 4.1.3. | Accelerator and source capital investment | 199 |
| 4.1.4. | Experiments capital investment | 200 |
| 4.1.5. | Instrumentation and detector development - capital investment | 200 |
| 4.1.6. | Computing capital investment | 200 |
| 4.1.7. | Recurrent | 200 |
| 4.1.8. | Personnel | 201 |
| 4.1.9. | Current annual ESRF budget and Upgrade Programme | 202 |
| 4.1.10. | Summary | 203 |
| 4.2. | PLANNING THE ESRF UPGRADE | 204 |
| 4.2.1. | Introduction | 204 |
| 4.2.2. | Beamlines | 204 |
| 4.2.3. | Experimental hall extensions | 204 |
| 4.2.4. | Accelerator and source developments | 204 |
| 4.2.5. | Enabling instrumentation and technology | 205 |
| GLOSSARY AND CONTRIBUTORS | | 207 |
| ANNEXE I CONCEPTUAL DESIGN REPORTS | | see Volume 2 |
| ANNEXE II SAFETY | | see Volume 2 |
| ANNEXE III OTHER SYNCHROTRONS | | see Volume 2 |
| ANNEXE IV ESRF FACTS AND FIGURES | | see Volume 2 |

Introduction

Extending the five year ESRF Medium-Term Scientific Plan, this report describes the science and technology programme of the ESRF and proposes an exceptional, far-reaching and ambitious Upgrade to be implemented from 2008 to 2017. This Upgrade Programme is designed to support the scientific communities of the ESRF's Member and Scientific Associate countries to better address the future scientific challenges facing society: health, energy, environment and climate change, new materials and nanotechnology. It will deliver beamlines with remarkable new capabilities and a unique associated environment that will greatly enhance the scientific impact of the ESRF to an extent that cannot be achieved with the normal ESRF annual budget.

The ESRF Science and Technology Programme 2008-2017 consists of four Parts and the Annexes. Part 1 describes the scientific challenges that ESRF scientists, users, and the Scientific Advisory Committee anticipate for the next ten years. X-ray experiments designed to answer these questions will require new technologies to be developed, as outlined in Part 2. Finally, Part 3 presents the extensions to the accelerator and source, and facility infrastructure needed to implement the new technologies, whilst a summary of the project budget, staffing and planning is presented in Part 4. The series of Annexes includes a set of Conceptual Design Reports describing potential new beamlines at the ESRF.

The ESRF

The international site accommodating the ESRF, the ILL (Institut Laue-Langevin) and the EMBL (European Molecular Biology Laboratory) Grenoble Outstation is unique in the world with a high-energy third-generation light source and a high-intensity neutron source located together. This provides cutting-edge research, education and training and is an outstanding opportunity for Europe to develop a set of complementary facilities with the ESRF Upgrade Programme and with the separate ILL 20/20 Upgrade.

The ESRF's 6 GeV storage-ring light source, built in the early nineties, is the first insertion device based ("third-generation") synchrotron radiation source. The ESRF has been successful, both in terms of technical innovation and in generating a very large volume of new and exciting science. With over 4000 scientists visiting each year, resulting in more than 1400 refereed publications, the ESRF is recognised as one of the world's most innovative and productive synchrotron light sources. This success is also measured by requests for beam time from the community of users of the ESRF, consistently exceeding the available beam time by a large factor and increasing by 30% over the years 2000 to 2006. The number of ESRF member states has also grown from the original twelve to the present eighteen subscribing countries. Inspired by the success of the ESRF model, several ESRF member countries have decided to construct third-generation national light sources (SOLEIL in France, PETRA-III in Germany, DIAMOND in the United Kingdom, SLS in Switzerland, MAX IV in Sweden, and ALBA in Spain).

An essential element of the ESRF's success has been the continuous refurbishment programme that has enabled ambitious science-driven technical innovation in crucial areas such as X-ray optics, detectors, sample environment, control systems, and accelerator physics. The technological advances mentioned above, the outcome of more than ten years of research and development in synchrotron science, now permit an ambitious renewal and upgrade programme covering all aspects of the ESRF's activities.

Why an Upgrade Programme?

Synchrotron radiation science owes its success to its impact in the science of materials considered in the widest sense. The ESRF offers first class facilities for a wide range of scientific programmes and aims to maintain and improve its engagement in these areas. This will continue to enable existing scientific communities to tackle both fundamental and applied problems.

The uniqueness of X-ray synchrotron radiation beams

Ever since the discovery of X-rays by Wilhelm Röntgen in 1895, X-rays have been used as the tool to probe matter at all levels of detail. X-rays are able to penetrate matter in a non-destructive way and to provide information on its structure, dynamics, processes, and chemistry.

The evolution of storage ring light sources from the parasitic first-generation to the dedicated second-generation and the current third-generation machines, like the ESRF, with small emittance and use of undulators as X-ray sources, has led to a revolution in the use of X-rays to study matter. Synchrotron light sources based on electron storage rings provide intense X-ray beams for a remarkably wide range of scientific studies. Synchrotron light has become an essential tool for investigations in archaeology, biology, chemistry, materials, medicine, palaeontology, physics and many other scientific disciplines, due to the unique combination of X-ray brilliance, source stability, energy spectrum, coherence and polarisation properties. Storage ring light sources such as the ESRF will continue to provide an irreplaceable service to the scientific community requiring analytical tools based on X-rays.

Although the ESRF is Europe's leading provider of hard X-rays (up to 500 keV in energy), as it stands today the ESRF cannot answer fully the scientific questions that are expected to arise in the medium-term future. The Upgrade Programme will allow the ESRF to address these challenges by developing the necessary site infrastructure, engineering technology and scientific instruments, all of which will be available to users and collaborators throughout Europe, and to secure the forefront role for the ESRF in synchrotron radiation based science. Although the new light sources being built across Europe will make major scientific contributions, the ESRF's unique combination of extremely brilliant and stable X-ray beams, world-leading beamlines and instrumentation and an unparalleled level of scientific and technical support will continue to provide answers to the critical scientific questions of the future.

These much improved scientific capabilities of the ESRF on completion of the Upgrade Programme will have their greatest impact in the following five "highlight" areas:

- Nanoscience and nanotechnology
- Pump and probe experiments and time-resolved science
- Science at extreme conditions
- Structural and functional biology and soft matter
- X-ray imaging

Developments made in these areas will directly promote and stimulate the science underlying the European Union priority themes of health, energy, environment and climate change, new materials and nanotechnology.

The Upgrade Programme will require a total investment of 287 M€ over ten years of which the ESRF will fund 77 M€ from its regular budget. In comparison, the creation of a wholly new synchrotron centre with the capabilities of the upgraded ESRF would cost between one to two billion euros, with a considerable lead time before being operational. The special investment proposed for the ESRF Upgrade is particularly cost effective, being based on an existing, operational investment made by the member countries. The Upgrade Programme can be initiated rapidly to respond to the requirements for the unique capacity of the ESRF across all areas of synchrotron based science.

Strategic considerations

The development of the Upgrade Programme has been guided by the following strategic considerations:

- The strength of the ESRF has always been centred on the quality and high degree of specialisation of its beamlines including an unparalleled service to its users. This approach will be maintained.
- The ESRF Upgrade Programme will take into account the new synchrotron radiation sources in Europe and elsewhere. The updated beamline portfolio must match the scientific demands of its Member Countries, including those that do not benefit from a national source.
- The scientific case for storage ring based synchrotron radiation research must take into account X-ray free electron laser (XFEL) sources such as the one planned in Hamburg. The ESRF will cultivate and develop new ideas to be fully exploited later at XFELs.
- At a time characterised by a great need for new and expensive research infrastructure in many areas of science, the upgrade of the ESRF must be economically attractive.

These points have all contributed to the decision to maintain the present number of public beamlines at the ESRF. Nonetheless, the Upgrade Programme will provide the potential for a small expansion. Up to five more beamlines could be realised if justified during and after the proposed ten years duration of the Upgrade. Over the next ten years the Upgrade Programme will be implemented such that the ESRF will continue to operate at almost full capacity. During the timescale of the project, the scientific opportunities and the details of how beamlines will be upgraded will continue to evolve. The Upgrade therefore intentionally leaves scope to be refined and redirected during the project lifetime.

Highlights of ESRF science

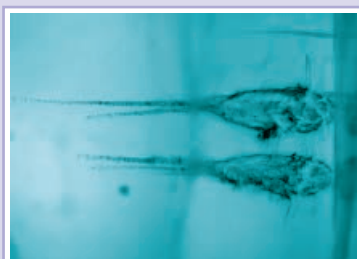

Tracks left by minute comet particles trapped in aerogel.

Credit NASA.

- Particles returned to Earth by the Stardust spacecraft from comet Wild 2 have yielded precious information about the origin of the solar system.

Although the

particles are tiny, the X-ray beams available at the ESRF can be even smaller, enabling researchers to illuminate the cometary material and in some cases determine the distribution of elements within the particles without damaging them. These results describe the overall composition and chemistry of the samples returned by Stardust.

Reference: See special edition of *Science* (2006) **314**, 1731-1735.

- The oxygen-storing protein myoglobin has been “filmed” at work in exceptional detail. The motion of the protein, which plays a central role in the production of energy in muscles, was recorded using ultra-short flashes of X-rays. The new insight in the functionality of myoglobin has led to a deeper understanding of the molecular processes associated with respiration.

Reference: See Schotte F., Lim M., Jackson T.A., Smirnov A.V., Soman J., Olson J.S., Phillips G.N., Wulff M., and Anfinrud P.A. (2003), Watching a Protein as it Functions with 150-ps Time-Resolved X-ray Crystallography, *Science*, **300**, 1944-1947.

- The coherence of the ESRF's X-ray beams opens the possibility to exploit phase contrast imaging to observe detail at unprecedented levels within a sample. 3D X-ray holo-tomography based on phase contrast was employed to look inside precious opaque amber resin containing fossilised insects and spiders from the Carboniferous period. The study of these organisms permits a reconstitution of

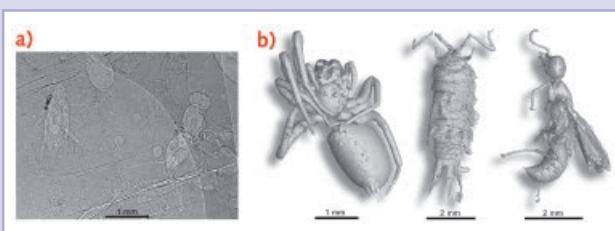

Courtesy M. Lak, P. Tafforeau.

- Radiography in propagation phase contrast mode of opaque amber blocks from Charente-Maritime, France (990 mm of propagation distance, pixel size: 5 μm).
- Examples of virtual 3D extraction of organisms embedded in the opaque amber.

environments existing up to hundreds of millions of years ago.

Reference: See Tafforeau P., Boistel R., Boller E., Bravin A., Brunet M., Chaimanee Y., Cloetens P., Feist M., Hozzowska J., Jaeger J.-J., Kay R.F., Lazzari V., Marivaux L., Nel A., Nemoz C., Thibault X., Vignaud P., and Zabler S. (2006), Applications of X-ray synchrotron microtomography for non-destructive 3D studies of paleontological specimens, *Applied Physics A*, **83**, 195-202.

- Understanding the heat transfer mechanisms from the Earth's core and mantle to the outer layers is of great interest since it can explain natural phenomena such as earthquakes, volcanoes, movements of tectonic plates and formation of mountains. Based on experiments at the ESRF reproducing the conditions deep inside the Earth, it was found that iron-bearing magnesium silicate perovskite, the Earth's most abundant mineral, transforms, when pressure is applied, to a state where radiation could play a far more important role in heat transfer in the lowermost part of the mantle. This novel mechanism is changing our vision of the dynamics of the deep Earth.

Reference: See Badro J., Rueff J.-P., Vankó G., Monaco G., Fiquet G., and Guyot F. (2004), Electronic Transitions in Perovskite: Possible Nonconvecting Layers in the Lower Mantle, *Science*, **305**, 383-386.

- Ribosomes are the intracellular “machines” that fabricate proteins according to the instructions contained in genes. These complex macromolecules, found inside cells, are made up of both proteins and strands of RNA. Determining the atomic-resolution structure of the ribosome, using the brilliant X-rays of the ESRF, has helped to better understand their mechanism of action, in particular the effect of antibiotics on the production of proteins in a bacterial ribosome.

References: See Schlünzen F., Zarivach R., Harms J., Bashan A., Tocilj A., Albrecht R., Yonath A., and Franceschi F. (2001), Structural basis for the interaction of antibiotics with the peptidyl transferase centre in eubacteria, *Nature*, **413**, 814-821; Carter A.P., Clemons W.M., Brodersen D.E., Morgan-Warren R.J., Hartsch T., Wimberly B.T., and Ramakrishnan V. (2001), Crystal Structure of an Initiation Factor Bound to the 30S Ribosomal Subunit, *Science*, **291**, 498-501.

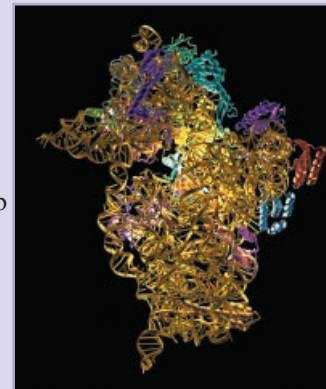

The structure of the ribosome 30S subunit with a binding site for antibiotics highlighted.

Image courtesy D. Brodersen and V. Ramakrishnan, MRC Laboratory of Molecular Biology, Cambridge.

Added value of the ESRF Upgrade

The Upgrade Programme will develop a multi-disciplinary, cross-fertilised research environment. The ESRF has a concentration of engineering, technical and scientific knowledge that exists nowhere else; the Upgrade will build on this to create an exceptional environment for new science to grow. The principal components of the Upgrade Programme are:

- The reconstruction of about one half of the ESRF's beamlines, to have much improved performance with an emphasis on nanofocus capabilities;
- A prudent programme of improvements to the accelerator complex to maintain and upgrade the very high brilliance and reliability of the ESRF's X-ray source, and in parallel, the preparation of a longer term design for a new higher brightness lattice;
- A wide-ranging programme of instrumentation development to underpin the beamline and source improvements;
- The construction of an extension to the experimental hall of 21,000 m² permitting sixteen new long beamlines with lengths between 105 and 140 metres for nanofocusing applications and to house new infrastructure;
- The development of productive science-driven partnerships, embracing both academia and industry, based on the wealth of knowledge available at the ESRF. Partnerships currently envisaged include soft matter science, high magnetic fields, and materials engineering, underpinned by the expertise of the joint ESRF-ILL theory group.

• Enhanced beamlines for new science

The Upgrade Programme encompasses the reconstruction of eighteen beamlines. The new and refurbished beamlines will answer new scientific needs with enhanced techniques and performances. A central theme of the Upgrade is the construction of long beamlines with highly specialised nanofocus capabilities, delivering even brighter "hard" X-ray beams. The future of synchrotron science is closely bound with experiments that probe samples with several techniques at the same time to obtain the most complete picture of the material or process under study. Special attention will be paid to the development of imaging techniques with high spatial resolution and to their combination with X-ray scattering and spectroscopy methodologies.

This report contains over forty proposals for beamline developments (these Conceptual Design Reports are included in Annexe I). Not all of these can be accommodated within the Upgrade Programme. Some proposals are mature whilst others require further development and key enabling technologies to be in place. Prioritisation into phased beamline developments will be made with the guidance and

input of the Science Advisory Committee and the ESRF user communities.

• Enabling technologies, tools and infrastructure

All ESRF beamlines will benefit from renewing beamline components such as detectors, optics, sample environments and sample positioning, supported by a longer term programme to maintain and refurbish the accelerator complex at the heart of the ESRF's activities. These developments underpin the science at the beamlines and are the key enabling technologies for the ESRF Upgrade. The ESRF is not alone in requiring new technologies, tools and techniques to enable science: international collaborations and partnerships will be formed to help drive developments in nanotechnologies, optics, computing and especially detector developments for the benefit of all synchrotron sources in the European Research Area.

The ESRF Science and Technology Programme 2008-2017 outlines the necessary enabling technologies and infrastructure. These tasks will be initiated at the start of the Upgrade Programme to allow time for preparation for the new beamlines. The core tasks of the programme, as presented in this report, are the development and implementation of:

- Instrument test stations to allow dedicated online testing of new hardware and software, open to all scientists and engineers interested in synchrotron radiation;
- X-ray optics systems to provide stable nanosized X-ray beams;
- Sample environments and sample management protocols for extreme conditions, fragile, precious or nanoscale samples;
- New detectors to enable new science;
- Upgrades to the accelerator complex;
- Experimental hall extensions for long beamlines;
- Computing hardware and software systems to manage experimental workflow from experiment inception to publication.

Context with other light sources

This is a period of remarkable development for synchrotron radiation science in Europe and across the world. A number of third-generation light sources are operating or are under construction, whilst several advanced free electron laser projects are in the planning or realisation phase. Below, the ESRF Upgrade Programme is positioned within this evolving context.

The main European light sources are listed in Annexe IV of this report together with summaries of the current status and plans. Also described are the two

other operational high energy storage rings, the Advanced Photon Source in the USA and SPRING-8 in Japan, both of which are currently also considering upgrades.

• National synchrotron sources in the EU

A number of new national light sources are being constructed or are becoming operational within the EU. These sources typically need to match the national user requirements. The ESRF, as the European synchrotron, is not driven by individual national requirements but has the ability to respond to target science at the European scale by developing unique opportunities with specific and innovative instrumentation combined with local skills. In this respect the ESRF has historically been and will continue to be the “nursery” of new synchrotron science in terms of skilled staff and instrumentation. It is important to note that several of the ESRF’s Member and Associate countries do not possess national-level synchrotron radiation facilities – the ESRF is their principal synchrotron resource. Consequently, the ESRF’s suite of beamlines must complement those available on national sources particularly where harder X-rays are concerned (see below), but must also provide a reasonable coverage of all fields as required by those member nations without their own national facilities.

Several high performance soft X-ray synchrotron sources have been operating for a number of years. Notable amongst these are ELETTRA (Italy) and BESSY (Germany), both of which have made significant scientific advances across a wide range of disciplines. The intensity of these soft X-ray sources, coupled with innovative photon and electron optics, has opened the path to new, non-destructive, chemical species and magnetic atom selective microscopies, which in some cases have pushed spatial resolutions to the nanometre level. Whilst there is some overlap with activities at the ESRF this work is largely complementary to ESRF studies.

At the hard X-ray end of the spectrum (energies greater than 50 keV), the only European source which can rival the ESRF performance will be PETRA-III (Germany), to be operational from 2009 (at which time the DORIS facility may be unavailable). Whilst PETRA-III will clearly be an outstanding low emittance source, the relatively small number of beamlines and high national demand is expected to have a minor impact on the overall European community which makes use of the ESRF’s forty-three beamlines.

Direct impact on the ESRF is expected from the new medium-energy sources (SLS, SOLEIL, DIAMOND and ALBA). It is interesting to note however that the start-up of the Swiss Light Source has only led to a slight decrease in usage of the ESRF by the Swiss community. While DIAMOND and similar synchrotrons will have

very high brilliance for X-ray energies up to at least 20 keV, a consideration of all factors governing the experimental signal strength (beamline divergences, apertures, etc.) shows that the cross-over energy where ESRF beamlines become superior is relatively low, and is calculated to lie around 10 keV.

• High-energy synchrotron sources worldwide

The ESRF is one of only three operational high-energy synchrotron sources worldwide. The two others, comparable and competitive to the ESRF, are the 7 GeV Advanced Photon Source in the US and the 8 GeV SPRING-8 in Japan. Both are producers of hard X-rays covering a broad spectrum of energies and techniques. The APS and SPRING-8 facilities are at present exploring options for their futures and are strongly committed to upgrade and renewal programmes for the coming years. The central scientific concerns are very similar to those of the ESRF, covering as they do the future problems of society. The ESRF Upgrade is critical therefore, for the European Research Area, its associated universities, institutes and industry to maintain their competitive edge on the world stage. Today, the ESRF has the opportunity to lead the development of 21st century synchrotron radiation provision.

• Free-electron laser sources

The impact of the various free-electron laser projects on the ESRF is expected to be less direct. The very low energy sources already operating provide experimental facilities for atomic and molecular spectroscopies and have strong programmes in biological fields (e.g. bio-medicine) in energy regimes far from those of the ESRF. The successful operation of the VUV FEL (FLASH) at DESY is opening up new and exciting fields of science on ultra-short timescales. The ambitious soft X-ray and X-ray projects such as FERMI at ELETTRA and the European XFEL at DESY are several years away from routine operation and similar projects in the US and Japan are at comparable states of advancement. Whilst these projects will make new time domains accessible, initially their major customer base will lie principally with the high power laser and atomic-and-molecular scientific communities. A significant period of test and development is foreseen before the X-ray FELs will become routine user facilities with reliable and well understood operation modes like the ESRF and the other third-generation synchrotron sources.

ESFRI 2006 Roadmap

The ESRF Upgrade Programme is highlighted as one of thirty-five infrastructure projects identified on the European Strategy Forum for Research Infrastructures (ESFRI) 2006 Roadmap. The roadmap was built by

consultation with expert groups on the basis of project science, pan-European nature and maturity. As one of the mature projects on the roadmap, the ESRF has applied for specific Framework Programme 7 funds to catalyse the Upgrade preparation and initiation and to help study optimisation of the ESRF organisation for the future. The application was very well received and at this time contract negotiations are being finalised.

Training, education and dissemination

The ESRF contributes significantly to the education of young researchers in their use of large research infrastructures. In contrast to most other large-scale facilities in Europe, the ESRF users come from almost all scientific areas, conferring a special role on the ESRF in terms of the training of researchers. Young scientists, PhD students and post doctoral fellows comprise more than half of the 6000 user visits to the ESRF each year to perform experiments, thereby learning to work in an international environment and to appreciate the opportunities a large facility has to offer. Many PhD students have obtained their degree based on research performed at the ESRF, not only those supported by the thirty existing ESRF PhD studentships, but also a large number of students from universities and research centres are working at the ESRF. The trainee programme enables many students to spend up to one year working at the ESRF. It should also be noted that only around one third of the ESRF scientific staff (scientists and post doctoral fellows) hold permanent positions. As a result of this recruitment policy, the ESRF has trained many of the scientists now working at other synchrotron facilities.

Every year more than ten workshops or schools are organised by and held at the ESRF, attracting young researchers to learn more about synchrotron science and ensuring effective paths for knowledge transfer. A major contribution is made by the ESRF to the HERCULES course (Higher European Research Course for Users of Large Experimental Systems): more than 1100 young scientists from all over Europe have been trained. During the last two years HERCULES was extended with one week HERCULES Specialised Courses, providing in-depth training on specific topics. These courses organised at the ESRF are recognised by many European Universities as a preparation for a PhD.

Being visible in the public eye is also important. The ESRF is active in participating in, and co-organising, events such as the Euroscience Open Forum, Science on Stage (in cooperation with its EIROforum partners), the *Fête de la Science*, open days and site visits for the public. As part of the international ESRF-ILL-EMBL site development scheme (not part of the Upgrade), a well equipped visitor and exhibition centre is planned.

This will enable the public (including school children, tomorrow's citizens) to explore the use of synchrotron light and neutrons in science.

The Upgrade Programme will keep the ESRF at the scientific forefront, ensure that the ESRF maintains its attraction for young scientists, and continue to contribute to the training in and dissemination of cutting edge synchrotron radiation based research.

Links with industry

The ESRF is accessible to industrial research teams and is involved in many fruitful partnerships with industry. Industry can use ESRF beamlines through the peer-review system for projects of scientific excellence with the obligation to publish results. Currently between 20 and 25% of the peer-reviewed experiments have a direct impact on applied research and industrial needs. Attracted by the high performance of the beamlines, the reliability of the source, the outstanding and customised service provided, and the possibility to exploit commercially the results obtained, industry is increasingly accessing the ESRF for proprietary research. In this case there is no requirement to publish the results, though industry does have to pay for the beam time. The income generated is used to improve the performance of the beamlines to the benefit of both academic and industrial users. The Upgrade Programme will enhance the unique facilities offered by the ESRF, helping to keep a competitive edge for European industry.

A substantial part of the ESRF's industrial activity comes from pharmaceutical companies that use the macromolecular crystallography beamlines for drug design. Other beamlines are used to carry out experiments for cosmetics, food products, plastics, papermaking, environment, chemistry, construction, metallurgy or other areas such as microelectronics. More and more techniques are being requested, such as powder diffraction, microdiffraction, EXAFS for studies on catalysis for the automotive industry, and microtomography.

The ESRF is engaged in other kinds of cooperation and partnerships with industry. This includes collaborative contracts for the design and manufacturing of prototypes of innovative equipment, projects within the Framework Programmes of the European Union where both academic and industrial groups are involved, and in co-financing of students or post-doctoral fellows. Industry's interest in the developments made at the ESRF has stimulated the implementation of a more pro-active policy on technology and knowledge transfer, through licensing to industrial partners. With the new developments achieved as part of the Upgrade Programme, technology transfer by the ESRF will increase over the next years.



The European Light Source

ESRF SCIENCE AND TECHNOLOGY PROGRAMME 2008-2017

PART 1

Science at the ESRF

Overview to PART 1

Science at the ESRF

Part 1 of the ESRF Science and Technology Programme 2008-2017 is the backbone of the ESRF Upgrade Programme. It presents the results of the discussions and work formally started in 2003, which was then referred to as the ESRF Long-Term Strategy. As part of this work, discussions were held with the ESRF Community as a whole, the Users Community, the different ESRF committees and counselling bodies, as well as researchers from other synchrotrons, to identify new science and techniques and combinations thereof that would lead to new challenging experiments over the next ten to twenty years. The ideas produced were summarised in the paper "New Scientific Opportunities at the European Synchrotron Radiation Facility", which was presented to the ESRF Council in June 2006 and received with enthusiasm.

Five scientific themes were identified as the core programmes that should drive the science performed at the ESRF by its users over the following decade:

- *Nanoscience and Nanotechnology*
- *Structural and Functional Biology and Soft Matter*
- *Pump-and-Probe Experiments and Time-Resolved Science*
- *Science at Extreme Conditions*
- *X-ray Imaging*

The chapters of Part 1 are written in the spirit of these five areas. They unite the present and medium-term scientific goals with the foreseeable scientific challenges of the future and aim to satisfy the scientific and technical expectations of the ESRF Users' Community for the next ten to twenty years.

The new science is dependent on evolving the existing beamlines into a portfolio of new beamlines, enhancing the accelerator and source complex and creating new scientific infrastructure. Of particular importance are new instrumentation (optics, sample environment and positioning, detectors, data retrieval, storage and analysis), the extension of the experimental hall, ancillary laboratories, and scientific partnerships. In this context, operational issues such as safety,

administration and personnel matters will need to be addressed. In other words, the scientific case is the foundation of the ESRF Upgrade Programme presented in this book.

The new science presented in this part is based on ideas of how the existing beamlines could evolve. These ideas are collected in the Conceptual Design Reports (CDRs) of both completely new and upgraded beamlines, presented in full detail in Volume 2. It should be noted that, despite the high degree of detail of the CDRs, they have not been finalised. The proposed CDRs have been developed over the past year by ESRF scientists with some input from the Users' Community. Validating these still requires a careful and thorough refinement that fully involves the interested users, who are an inherent part of the general ESRF scientific programme. As such, they stimulate the necessary subsequent discussion before they can be implemented. At present, the CDRs total more than forty beamlines and experimental stations whilst, as mentioned in the Introduction, the number of ESRF public beamlines should remain more or less the same. The number of CDRs therefore needs to be reduced. A very similar strategy was successfully used in the ESRF Foundation Phase Report (Red Book) to identify the beamline programme, which then evolved into the present thirty-one ESRF public beamlines.

Part 1 comprises five chapters. Each chapter is introduced by an extended abstract that summarises specific scientific challenges and links it to other aspects of the Upgrade Programme. In particular, it refers to its dependence on technical and engineering programmes such as building and infrastructure, accelerator and source, beamline instrumentation and computing. Relationships to industry and existing and new Partnerships, including possible funding from the European Commission, are pointed out. References to the relevant CDRs are also given in each section. The science described in Part 1 is complemented by Part 2 which describes the corresponding technology and engineering challenges. The infrastructure necessary to enable the Upgrade science is described in Part 3.

The first scientific area refers to "*Nanoscience and Nanotechnology*". The highly important role that synchrotron radiation science will play at the nanometre scale is mainly detailed in [chapter 1.1](#). It should be noted, however that this scientific theme is present, to different extents, in all chapters of Part 1. The new science arises from the great challenge in understanding how matter works when considering ensembles composed of a few 103 to 109 atoms. Different and increasingly important scientific issues range from "simple" cases, whereby these atoms are all equal or belong to a few species, to the extreme complexity of situations where these ensembles contain atoms of many different kinds in non-equivalent positions or chemical states. Aspects of nanoobject confinement on surfaces, the changing ratio between "volume" and "surface" atoms in particles of 10 to 100 nm sizes, their hierarchical organisations and behaviour under specific conditions make nanosciences of great relevance in many different scientific areas. In all these cases, advanced techniques are required to analyse and understand how a specific "nanoworld" works when the sizes are too small to use visible optical methods. Consequently, nanoscience is also present: *i*) in [chapter 1.2](#) dedicated to biology and soft matter, *ii*) in [chapter 1.3](#) dedicated to chemical, physical and engineering properties of materials, *iii*) in [chapter 1.4](#) dedicated to dynamics and correlation effects in materials at their constituting level, *i.e.* at the bonding among valence electrons and fundamental magnetic properties, and *iv*) in [chapter 1.5](#), investigating the potential of synchrotron radiation science in new areas of applications including medicine, palaeontology, environmental science and human heritage studies. Science at the nanometre scale depends crucially upon the development of even more advanced engineering and technology to study smaller and smaller objects as described in [chapters 2.1](#) and [2.2](#).

The second scientific area "*Structural and Functional Biology and Soft Matter*" is presented in [chapter 1.2](#). The benefits of tightly focused beams, scientific infrastructure, and stable and highly performing sample environments and positioning have already become apparent due to recent revolutionary approaches in these disciplines. The possibility of rapidly screening many small samples, the development of highly sophisticated sample environments such as micro- and nanofluidics and optical tweezing techniques, will allow extremely complex systems to be analysed. These experiments will produce enormous amounts of data and require very advanced data analysis, storage and handling capabilities. Scientific challenges include, for example, the basic mechanism of molecular machines and cellular reproduction, as well as the

complex architectures of advanced forms of organisation in soft matter materials. The support in theoretical modelling of these processes is going to be of critical importance. In this context, a serious reflection must start very soon on whether the joint ESRF-ILL theory group should focus more on theory and modelling in soft matter problems.

The "*Pump-and-Probe Experiments and Time-Resolved Science*" scientific area is described in [chapters 1.3](#) and [1.4](#). The increasing interest in time-resolved phenomena is underpinned by the scientific case of new large accelerator complexes such as X-ray free electron lasers (XFEL) and energy recovery linacs (ERL), whereby the study of materials with time resolutions able to record (film) the movement of clusters of atoms, single atoms and even electrons could become possible. Some of this work has been pioneered at third-generation sources and in particular at the ESRF, and will continue to grow in the coming years as a test bed for the science to be developed at these new accelerators over the next decades. Some work, however, will be very specific to third-generation sources (for example, whenever the high degree of wavelength tunability in X-ray spectroscopy is necessary and when work is carried out in the frequency domain). The ESRF also expects to remain more effective than XFEL sources when using a time resolution longer than 100 ps. The technological developments required by pump-and-probe and time-resolved science are presented in [chapter 2.3](#).

A very attractive aspect of synchrotron radiation is the capability to study minute quantities of matter. This is the case under extreme thermodynamic conditions of pressure, temperature and magnetic field, which can be maintained only in a very small volume or over a short time. An ambitious programme called "*Science at Extreme Conditions*" will extend the ranges of pressure, temperature and magnetic field. Such sample environments are necessary for: *i*) materials science and chemistry ranging from fusion as a new source of energy to Earth and planetary science, cosmology, and the synthesis of (new) materials under very high temperature and pressure ([chapter 1.3](#)), *ii*) fundamental physics of materials under high pressure, temperature and magnetic field and the combination of these parameters at the extreme values ([chapter 1.4](#)), and *iii*) environmental science under extreme and harsh conditions ([chapter 1.5](#)). The ESRF theory group will have an important role to play in this, to stimulate and suggest ideas of experiments addressing the most challenging open problems in today's solid-state physics. The availability of extreme conditions depends upon developments in highly specialised sample

environments, which are described in [chapter 2.4](#). Also proposed in [chapter 2.4](#) is a facility to produce very high magnetic fields on samples on X-ray beamlines, under both pulsed and continuous (DC) conditions. This facility would be unique worldwide, and enable the study of both magnetic and geometric structural properties with atomic resolution of materials under fields up to 30 T in DC mode and 50 T in pulsed mode.

Similarly to the highlight area of science on the nanometre scale, the broad technique-oriented area of "*X-ray Imaging*" is present throughout this part. All of the aspects addressed and subsequently developed are intimately related to the shape and size of the X-ray beams, and in the way the X-rays are detected. New X-ray imaging capabilities present very attractive and innovative applications of synchrotron radiation in areas such as medicine, environmental science, palaeontology, human artefacts, archaeology, etc. This is due to the capability of X-rays to probe both small and large samples and to access chemical and magnetic properties, often in a non-destructive manner. These appealing and fascinating possibilities, for which the ESRF is already conducting important pioneering projects, are presented in [chapter 1.5](#). As mentioned above, the technological aspects are elaborated in Part 2.

The combined chapters of Part 1 give an overview of the exciting science that the Upgrade will enable. These scientific areas address the most relevant aspects of today's scientific challenges to enable tomorrow's everyday technologies: Nanoscience for its impact in large data processing, storage and communication; Condensed-matter physics and chemistry, especially at its extreme conditions, for its impact on new energy programmes and transportation strategies; Biology and soft matter, for their relevance in new medical insights and health issues, as well as for the development of new "intelligent" materials; And finally, X-ray imaging, for its numerous applications, amongst which, an understanding of our environment and improving pollution issues, and contributing to a better insight of the past of our planet to better address the future of our society. The Upgrade Programme will not only benefit the ESRF and its users, but its strong collaborative aspect with other light sources, academic institutes and industrial partners will mean that new science and its related technical developments will be promoted even further.

1.1. Science at the nanometre scale

Science context

The characterisation of samples at the nanometre scale will play a central role in both fundamental and applied sciences in the near future. New challenges can be expected as part of the developments within this field. Synchrotron-based X-ray techniques (diffraction and scattering, imaging and spectromicroscopies) are pivotal to nanometre-scale science.

The nanosciences offer great potential to create new materials with tailored properties that strongly depend on the specific hierarchy of chemical or physical components, organised at different length scales. The function and behaviour of these new materials can therefore only be understood if their microscopic structure and dynamics over all length scales down to the molecular and atomic levels are also known. New and specialised X-ray analytical instruments are needed for the study of these materials. Their characteristics will need to be enhanced towards ultra-high spatial resolution, high sensitivity and more precise 3D information, which ultimately can be developed to include time resolution and chemical selectivity.

Based upon the ten years of experience of the ESRF with microbeams, the area of "nanoscience and nanotechnology" is one of the five pertinent broad scientific themes that make up the foundations of the Upgrade Programme.

Added value of the Upgrade

Future developments in nanoscience activities require specific problems to be addressed. This part of the Programme will be based upon three key components:

- Development of several long nanofocus beamlines enabling hard X-ray nanoprobes (50 to 20 nm beam size) and *in situ* experiments.
- Advancing innovative X-ray-based methodologies with special emphasis on imaging techniques and their combination with X-ray scattering and spectroscopic techniques and use of X-ray beam coherence.
- Furthering expertise in sample handling, visualisation and off-line characterisation

techniques. The development of ancillary infrastructure and associated specialised laboratories shared between the different beamlines will form an important element of this project.

This ambitious programme on science at the nanometre scale will be carried out by thoroughly coordinating both its technical and scientific aspects. This will be essential in developing effective and productive science-driven collaborations around specific scientific projects, which involve expert teams. This part of the Upgrade Programme will be one of the main driving forces towards new strategic developments in beamline instrumentation and managing nanoscale samples. Its success will provide unique instrumental, methodological, and scientific opportunities for the development of nanoscience in its fundamental physics aspects which will impact biology, medicine and materials sciences. Some aspects of other important scientific areas such as environmental sciences, and earth and planetary sciences will also benefit from this programme.

Key questions

Highly automated X-ray based synchrotron nanoprobes can provide the unparalleled multilevel information necessary to explore new nanoscience domains and to answer a broad range of high impact scientific questions such as:

1. What are the driving phenomena behind pollution processes involving nano-particles (*e.g.* global dimming, ash particles, colloid transport)?
2. How can electro-migration be minimised in the manufacture of microelectronic components?
3. What are the roles of trace metals in neurodegenerative diseases?
4. How do extremophile bacteria adapt metabolic processes to their environments?
5. How do quantum dots behave under strain?

The new X-ray nanoprobes of the Upgrade Programme will help scientists to understand and find answers to problems such as those listed above by providing unique information on 3D location, quantification and chemical state of trace elements at unprecedented sensitivity and spatial

resolution, and, ultimately time dependence. Furthermore, hard X-rays enable specific sample environments so that real systems in their near native environments can be studied.

Expected user communities

Science at the nanoscale, through its very nature, addresses scientific questions over a broad range of disciplines. These disciplines are linked to topics covered by other chapters of this report. The ESRF nanoscience programme will have a major impact in nanotechnologies by providing innovative and unique analytical tools. Scientists and engineers working on new challenging projects in microelectronics, medicine and environmental sciences are specifically targeted. Furthermore, the Upgrade Programme will also enhance visibility for the ESRF in European nanoscience activities and foster a strong proactive role in attracting new expert partners, who are not normally users of synchrotron light.

Enabling technology and infrastructure

The success of nanoscience at the ESRF is dependent upon a strong programme of enabling technologies that puts its emphasis on small beam production and stability.

- *Buildings and infrastructure:* A major part of the programme involves constructing long nanoprobe beamlines into the extended experimental hall (see [chapter 3.2](#)). The technical implications of this are substantial for low vibration and thermally stable environments. The building and infrastructure programme involves the creation of a dedicated space for a Technical Platform for Nanoanalysis.
- *Accelerator and source:* The increased photon flux and brilliance will be of benefit to this scientific area.
- *Beamlines and instrumentation:* These technologies impose specific stringent infrastructure issues related to new long beamlines (*e.g.* mechanical and thermal stability) and nanofocusing X-ray optics with a highly stable nanofocus beam pinned on the sample and with high sensitivity detectors. Development of sample environments for nanoscale samples is essential (*e.g.* proper management of radiation damage induced by nanobeams will be a key issue of this programme).
- *Computing:* The programme will be particularly demanding as far as data storage capacity and sophisticated beamline control are concerned.

Partnerships

Nanotechnology and nanoscience are already promoted through several networks and partnerships. The ESRF is planning to develop a Technical Platform for Nanoanalysis which will contribute to an improved synergy between the nanoscience user community and synchrotron scientists.

Industry and technology transfer

Developments at the ESRF will greatly benefit European industry, especially through partnerships enabling new technology.

1.1.1. Introduction

X-rays are routinely used for the non-destructive characterisation of materials at the macroscopic, mesoscopic, and atomic levels. A significant part of the ESRF Science and Technology Programme 2008-2017 therefore puts forward science cases dealing with the nanoscale and several chapters give examples of nanoscience in differing situations. This chapter is more specific and concentrates on the dramatic evolution of synchrotron-based instruments in terms of spatial resolution and detection limits. Indeed, the performance envisaged for the new nanoprobe beamlines, as proposed within the framework of the Upgrade Programme, will make possible new ways of characterising material at the nanoscale. Nanoscale is a new term used to describe scale, whereby the properties of materials depend on size and shape, as well as composition, and differ significantly from the same properties in the bulk. Particular attention will increasingly be placed on understanding how a material behaves from the atomic/nanometre level via microstructure to macrostructure levels using advanced analytical techniques and computer modelling. It is hoped to improve both conventional bulk materials, such as steel or wood, and new functional materials for increasingly smaller, smarter devices, in the fields of microelectronics and nanomedicine to give two examples. Analysing samples on the nanometre scale will therefore be crucial for both fundamental and applied sciences (for more background see an overview in the "European White Book on Fundamental Research in Materials Science", 2005).

Using nanoscience to create materials with specific chemical and physical hierarchies in order to achieve tailored properties is a concept that has been widely recognised. It is important to assess these systems as a whole, as their structural, dynamic, electronic and magnetic properties will be closely related. Measuring some of these properties using techniques such as high resolution transmission electron microscopy, scanning probe microscopy and various kinds of spectroscopic methods has become routine but limitations of these are, nonetheless, apparent. In this case, synchrotron-based X-ray analytical techniques, such as diffraction, scattering, imaging, and spectromicroscopies, play a major role in complementing existing tools. Routine focal spot sizes of about 50 nm (or even smaller) will allow conventional X-ray-based techniques to be used in combination with local probing. Furthermore, the physical penetration of hard X-rays enables specific sample environments to be developed in order to study realistic systems in their near-native environment rather than making use of model systems. A unique and key feature of hard X-rays remains their ability to provide data *in situ* in environmental chambers such as high or low

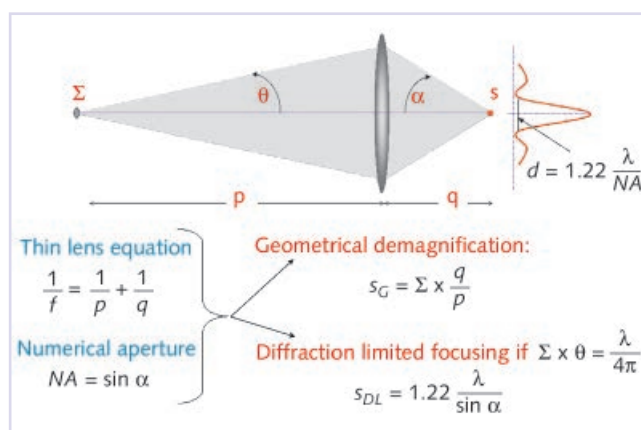

Figure 1.1.1: Optical demagnification: Assuming perfect imaging, the size of the focal spot, s , is given by the size of the source, Σ , multiplied by the distance from the focusing element to the focal spot, q , and divided by the distance from the source to the focusing element, p . The minimum spot size is limited by the geometrical demagnification, $s_G = \Sigma \times q/p$ and the diffraction limit, $s_{DL} = 1.22 \lambda/\sin \alpha$.

temperature, high pressure, or wet cells. The Upgrade Programme will, indeed, make it possible to put these methods fully into practice. The production of hard X-ray nanobeams is not possible without a significant amount of technical development being carried out. The development of long beamlines will, for the first time, allow the source size (in both directions) to be fully exploited, whilst keeping the working distance large enough to accommodate innovative *in situ* experiments (see chapter 2.2).

When using a single focusing element, the size of the focal spot is limited by the demagnification of the source size, and the diffraction limit (see Figure 1.1.1). In theory, a small beam could also be produced using a more complicated optical arrangement on a shorter beamline. In practice, however, the number of X-ray optical components should be restrained whenever possible in order to minimise beam degradation from sources such as mirror slope errors, absorption in refractive elements, and thermal and vibrational stability (see chapters 2.1 and 2.2). It should be noted that no single class of focusing optics is expected to be universally applicable and the demand for improved diffractive, refractive, reflective, and beam-concentrating optics will continue to develop (see chapter 2.1). Hard and soft X-ray focusing optics are now reaching almost similar level of performances with focused beam sizes below 20 nm. However, these remarkable achievements remain at the demonstration stage and are still far from routine. Besides they have to be fully integrated into stable and reliable X-ray microscopes. Such implementations will require not only outstanding quality optics, but also ultimate control of all experimental and environmental parameters (*e.g.* temperature, vibration). It is worth noting that, in

many cases, the probe dimensions (particularly in the horizontal direction) are no longer limited by the focusing device performance but rather by the geometrical laws of optics, *i.e.*, the source size, the source-to-optics and optics-to-sample distances. For higher X-ray energies, this situation is aggravated when the optical devices display chromatic focusing behaviour since the increase of the focal length with decreasing X-ray wavelength tends to lower the demagnification of the source image. The construction of long beamlines exceeding 100 m will offer not only the possibility to produce small probes but also to obtain longer working distances, providing more space for specific sample environment. A disadvantage of this scheme is the flux loss due to limited aperture of the focusing optics.

Over the coming years, competition will become fierce as far as the worldwide simultaneous development of laboratory instruments and dedicated synchrotron beamlines is concerned. In this light, a synergic development of synchrotron-based analytical techniques will allow a unique ensemble of capabilities to be offered for the study of complex systems. This chapter covers three specific topics: surface and interfaces, soft condensed matter and biology, and hard materials. This division helps to distinguish between developments in different fields, but there is an obvious overlap of this chapter with other science chapters.

The programme on science at the nanometre scale will be put into place in such a way as to ensure that both technical and scientific projects are coordinated correctly. This, in turn, creates the essential foundations needed to develop specific scientific projects involving expert teams. This part of the Upgrade Programme will be one of the major driving forces for source, X-ray optic, X-ray detector and beamline engineering developments (Figure 1.1.2). At the same time, the development of ancillary infrastructure and associated specialised laboratories shared between the different beamlines will constitute an important element of this project, with the development of advanced expertise in sample handling, visualisation and off-line characterisation techniques.

The new infrastructure envisaged as part of the Upgrade Programme will allow a Technical Platform for Nanoanalysis to be created and related scientific areas to be developed. This is a unique opportunity for the ESRF. The latter has pioneered most hard X-ray imaging techniques. The potential of combining diffraction-based techniques and real space imaging methods will be crucial to future enhancement of its experiments. Coherent diffraction imaging is, for example, one of the areas in which the ESRF has to develop new expertise. The long-standing experience of the ESRF in developing

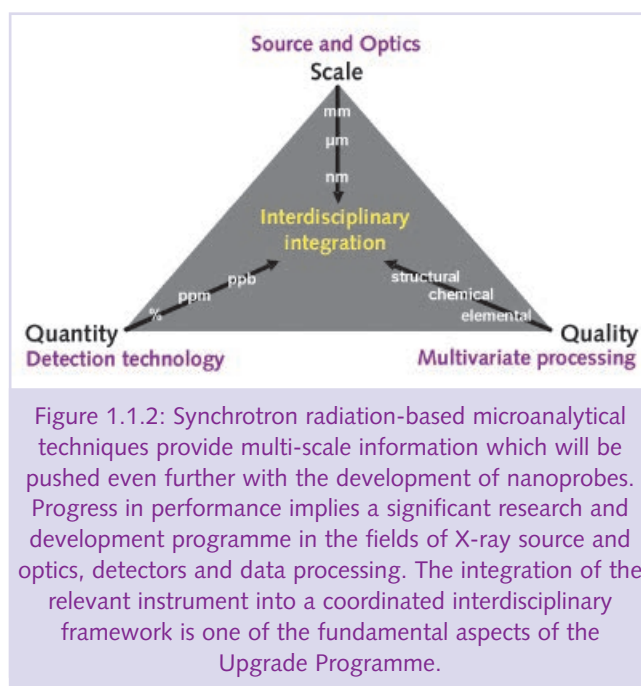

instruments with micrometre or sub-micrometre lateral resolution will serve as a useful base in developing these new programmes. These constitute a valuable opportunity for the ESRF to become a federating partner in various fields of nanoscience.

1.1.2. Single objects at surfaces and interfaces

Unique structural, chemical, and electronic properties are a result of the reduced dimensionality of surfaces and interfaces. The increasing size of the unit cells now forthcoming requires increasingly large data sets, whilst limiting the measurement time needed to prevent decay. However, surface science has expanded into areas which were usually considered as being too "dirty" to be associated with this discipline, such as heterogeneous catalysis, solid/liquid interfaces and friction, electrochemical plating, corrosion, batteries and fuel cells, soft condensed matter and biology. High penetration power and/or high momentum resolution of X-rays permits the study of surfaces/interfaces under real conditions and on a wide range of length scales. Higher brilliance, smaller beams, and vastly better detectors are needed to limit differences between the analysis of structure and properties on the atomic, nano, and mesoscopic scales, and to better exploit the time domain. The enhanced performances of both the ESRF source and beamlines will foster further developments of techniques such as coherent diffraction imaging, hard X-ray photoemission spectroscopy and microscopy, and photon correlation spectroscopy. This will allow the structural, chemical, and electronic properties of

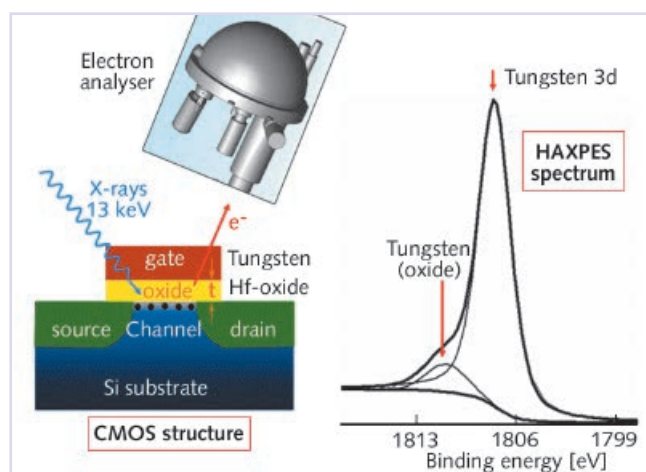

Figure 1.1.3: CMOS field effect transistor structures currently have lateral dimensions of down to 45 nm with layer thicknesses of several nanometres. The whole depth of layer structure can be accessed by hard X-ray photoelectron spectroscopy (HAXPES). The interfacial oxide of the metal gate can be identified using photoelectron kinetic energies >10 keV, which exhibit a probing depth of >10 nm. The ESRF Upgrade will satisfy the requirements of industry and fundamental research to analyse and study key structures like these on the nanoscale.

surfaces and interfaces on a range of length scales to be thoroughly characterised.

Microelectronic devices

Microelectronic devices have entered the nanoregime. Complementary metal oxide semiconductor technology (CMOS) will show 20 nm feature sizes by 2011 with crystalline and amorphous functional parts and nanometre-sized quantum dots already contained in optoelectronic devices. The electronics industry needs proper analytical tools for diagnostics and for its own further development. The increasing surface-to-volume ratio with shrinking device sizes means that the properties of a multitude of interfaces have become increasingly important and can dominate device performance. At the ESRF, the proposed nanobeam projects have been designed with this in mind. Coherent diffraction imaging (CDI) can assess the shape, size, strain and composition of individual nanostructures. However, it is worth noting that for CDI to develop from one of the most exciting emerging X-ray imaging techniques explored today, it will require substantial instrumental (highly coherent, bright and stable beamlines) and theoretical developments (model reconstruction) to reach maturity. Although ESRF is in the forefront for most of the X-ray imaging techniques, we are still far behind the other sources active in CDI. There is no doubt that the Upgrade Programme, in many aspects (source, beamline, detectors) will offer a key opportunity to boost the development of this method.

The EXAFS, XRD, and SAXS techniques can determine structure and microstructure, and AXRD, ASAXS, XFS and HAXPES can probe elemental composition (Figure 1.1.3). XFS offers a larger probing depth ($\gg 20$ nm) and HXPS, with its high energy resolution (100 meV at 10 keV), can reveal specific chemical environments in the bulk and at interfaces with probing depths of about 20 nm (Zegenhagen *et al.*, 2005). X-ray photoelectron spectroscopy will strongly benefit from the increased brilliance of the machine, allowing energy resolution far below 100 meV, whilst delivering adequate flux in the hard X-ray range.

Furthermore, the recent trend for optoelectronic devices to go towards nanotechnology will mean that new optical analysis tools will be required with site selectivity at the atomic level. Structural defects at the nanoscale, such as local lattice distortions, point defects and dopant positions, determine the quantum confinement effects, electronic state fluctuations and, consequently, the optical efficiency. These properties have, up until now, been studied separately by various analytical methods. However, in order to completely understand the quantum effects, it is necessary to study the physical relationship between local atomic coordination and the related electronic properties. There are currently no analytical tools allowing both types of information at the nanoscale to be accessed at the same time.

The combined use of X-ray excited optical luminescence (XEOL) and an X-ray nanobeam to probe the site selectivity of optical centres is an approach that could have considerable potential. The site selectivity is based on inner shell excitations (X-ray absorption spectroscopy) and detection of the induced recombination of electron-hole pairs (XEOL) (Zhang *et al.*, 2002). The feasibility of this approach has already been demonstrated (Martinez-Criado *et al.*, 2006), although it is currently limited by the lateral resolution of the X-ray probe. The migration of this XEOL spectrometer to a new nanoprobe beamline will enable the properties of single quantum structures to be accessed and provide unique information on non-linear phenomena, emitting processes and the role of excitons and polaritons on the optical properties of the emitting channels. Ultimately, XEOL 2D maps can be reordered together using elemental maps to correlate light emission with composition.

Hetero-epitaxial growth

Hetero-epitaxial growth is an important modern means of creating metastable materials with specific properties, which do not exist in their bulk forms. However, if the symmetry and the unit cell size of substrate and epilayer do not match, the films will

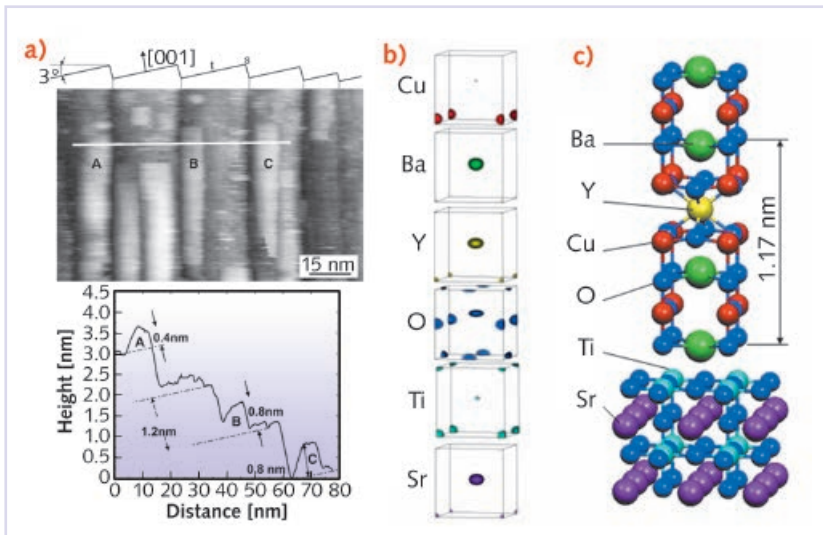

Figure 1.1.4: Nucleation of the 90 K superconductor $\text{YBa}_2\text{Cu}_3\text{O}_7$ on SrTiO_3 (001): a) STM image of nanometre-size islands; b) model-independent XSW/HXPS image of the internal atomic structure (Lee *et al.*, 2006); c) resulting structure. Using X-ray standing waves in combination with HAXPES reveals the structure of the nuclei.

grow most often in domains or by the formation of 3D islands (Stranski-Krastanov growth). This strain-driven, self-organised growth mode shows promise in its fabrication of structures, whose size, up until now, has not been able to be reached using other (mostly lithographic) techniques. The corresponding quantum confinement effects that can be exploited in new devices depend on structural properties such as morphology, strain and composition of the structures. Epitaxial films can have superior properties in comparison to their bulk counterparts such as extremely high critical currents in the case of superconductors. Nowadays, in determining the structural properties of these films and their interfaces, the ensemble average is sampled. TEM could be used but necessitates destruction of the sample. With a sufficiently small X-ray beam size, it will become possible to determine the anisotropic properties of an individual nanostructure, *e.g.* by CDI, XPS (HXPM), SEXAFS, or XPEEM (possibly in combination with XSW, Figure 1.1.4) (Yasufuku *et al.*, 2006).

CDI provides a non-destructive 3D X-ray diffraction microscopic tool. The ultimate resolution is set uniquely by the X-ray wavelength in order to address some important issues in quantum dot semiconductor materials, *e.g.* imaging the morphology of dots, internal strain, imaging thin interfacial layers at the substrate/quantum dot interface, and locating defects in the nanostructures. The phase problem in X-ray scattering can be solved by phase-retrieval techniques based on over-sampling and the structural information can therefore be obtained without the assumption (and possible bias) of models.

The CDI approach, both in the forward scattering direction (Figure 1.1.5) and at lattice Bragg angles (Figure 1.1.6), opens the door for the non-destructive and quantitative 3D imaging of a wide range of individual nanostructures. The ESRF Upgrade Programme is expected to increase the ESRF brightness and further development of CDI. This will

open up new possibilities for the 3D imaging of crystalline and non-crystalline materials, as well as disordered solids at nanometre-scale resolution.

Low dimensional magnetic systems at surfaces

The study of nanodots, wires and low dimensional systems can be seen as challenging both at present and for the foreseeable future. In chapter 1.4, nanomagnetism is explored by studying the ensemble

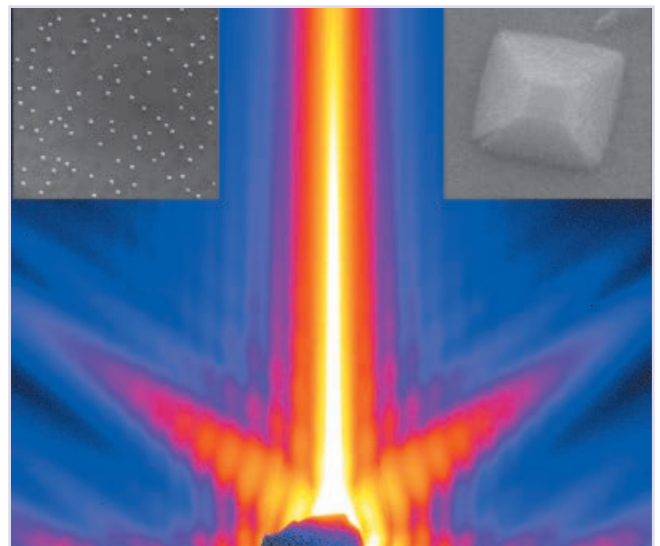

Figure 1.1.5: Forward scattering direction CDI. Ge truncated pyramids on Si, with a base length of 200 nm, are illuminated under grazing incidence and exit angle with coherent X-rays (ID01). The resulting coherent GISAXS pattern shows streaks of intensity perpendicular to the pyramids' facets. The fringes reflect the coherent character of the scattering process. Due to sufficient over-sampling of the pattern, phase retrieval can be used to reconstruct a model-free image of the pyramids. The development of this technique necessitates a coherent stable beam and will allow lensless, 3D imaging of arbitrary objects with nanometre dimensions.

Courtesy of Ivan Vartanyants, HASYLAB at DESY.

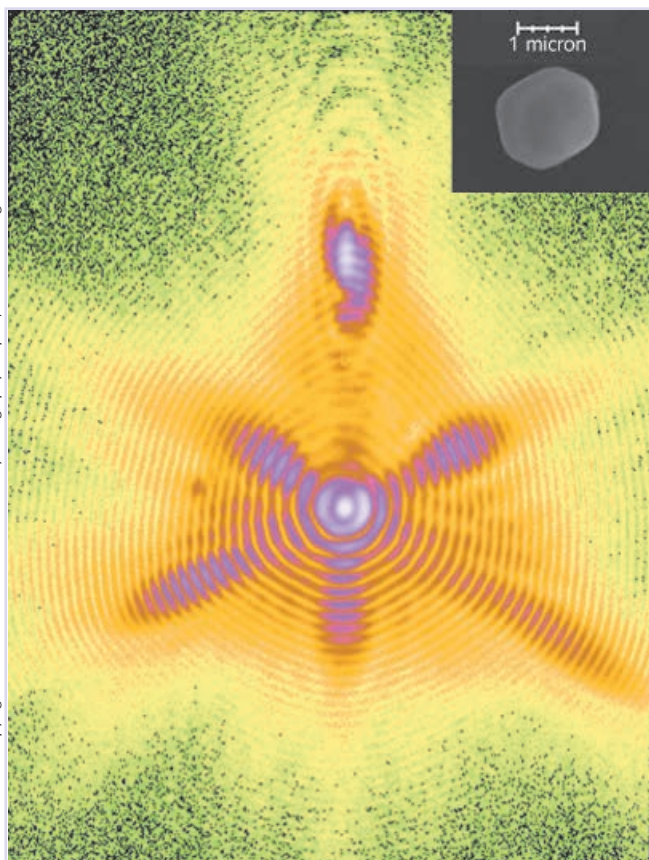

Figure 1.1.6: CDI at Bragg angles. Coherent diffraction pattern from a 1 μm gold crystal measured close to the centre of a (111) Bragg peak. By rocking the sample through the Bragg peak and recording slices through the 3D coherent diffraction pattern, a 3D real space image of the crystal is obtained from phase retrieval algorithms and reconstruction (ID01). No model assumptions are needed and the strain distribution in this free-standing crystallite is obtained. In the future, the challenge will be to determine without a *priori* model, the strain and composition in individual quantum dots coherently strained during growth due to the lattice mismatch with the substrate. A highly stable sub-micrometre X-ray beam will be necessary in combination with coherent flux.

average of nanoparticles. These are often prepared on surfaces to better control the objects to be studied. Specialised infrastructure is required to prepare such objects on surfaces, but X-rays make it possible to study their magnetic and dynamic properties in reduced dimensions with unprecedented sensitivity. A step beyond this means studying individual magnetic nanostructures at surfaces. This is only possible if nanosized beams with isolated nano-objects can be produced. This challenge requires not only state-of-the-art photon beams but also the requisite nanosample preparation and characterisation tools. Figure 1.1.7 shows a scanning tunnelling microscope (STM) image of nanoscale CoPt bimetallic islands on a platinum surface. Using an X-ray nanobeam, a single object can be studied and analysed, by utilising the unique element specificity of X-ray absorption

spectroscopy, which is not possible by other means. For example, the magnetic properties of the cobalt perimeter atoms could be studied separately from those of the core atoms. These experiments can be seen as challenging as they not only need small beams, but a complex sample environment with low temperatures and high magnetic fields.

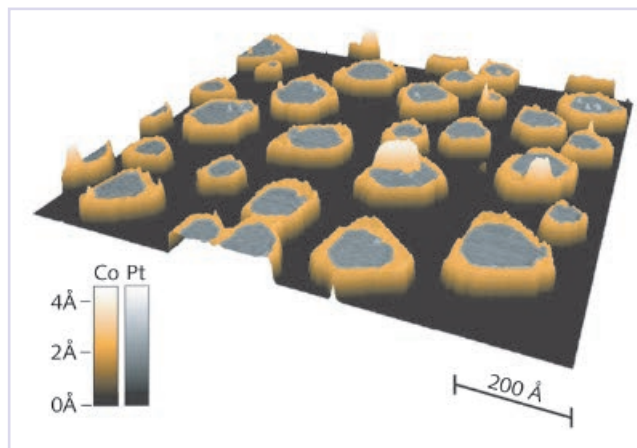

Figure 1.1.7: Tailoring magnetic properties in bimetallic islands: A 3D view of an STM image of one-monolayer-high islands with a platinum core (grey) and an approximately three-atom-wide cobalt shell (yellow). Understanding the different contributions to the magnetic properties coming from perimeter and core atoms is important for tailoring the magnetic properties of materials (Rusponi *et al.*, 2003). The small beams and complex sample environments enabled by the Upgrade Programme will allow the properties of the cobalt shell atoms to be studied.

Reprinted by permission from Macmillan Publishers Ltd: Nature Materials, S. Rusponi, T. Cren, N. Weiss, M. Epple, P. Bulushech, L. Claude, H. Brune, Nature Materials 2, 546 - 551 (2003), copyright 2003. <http://www.nature.com/nmat/index.html>

Nanobeams, combined with isotope sensitivity, are a unique way of probing dynamics and electronic and magnetic properties on atomic length scales. Visualisation of spin states in thin films, atomic layer by atomic layer, is currently feasible (see section 1.4.2). However, fast pixel detectors (see chapter 2.5) and pulsed magnetic fields (see chapter 2.4) are mandatory in order to access spin-dynamics down to the nanosecond scale. Both are envisaged within the framework of the Upgrade Programme. On the nanoscale, objects may have unusual dynamic behaviour: phonon folding, phonon softening and phonon lifetime will need to be accounted for. In a first feasibility study, the question of surface phonons was addressed: are the dynamics of surfaces different from the bulk? And how "thick" is a surface? Thin iron films have been prepared from the isotope ^{56}Fe which is not Mössbauer-active. One monolayer of the Mössbauer-active ^{57}Fe isotope was then successively incorporated at the surface and in deeper layers. This altered neither the chemical nor the structural properties. Nuclear inelastic scattering results show unambiguously that the phonons at the surface behave quite differently from phonons in the second layer, which resemble nearly bulk-like behaviour.

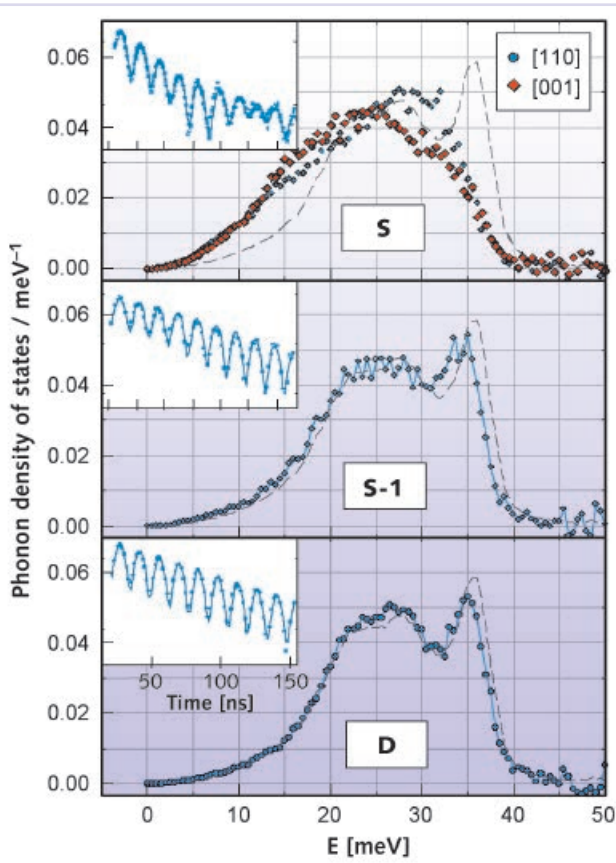

Figure 1.1.8: Experimental phonon density of states for the surface (S), subsurface (S-1) and deep single atomic (D) layers near the Fe(110) surface projected to [110] and also to [001] for S. Insets show NRS time spectra, giving access to electronic and magnetic properties, measured with the beam along [110], *i.e.* parallel to the magnetisation. Dashed lines show α - ^{57}Fe foil results (all data are from room temperature measurements). The Upgrade Programme will provide extended *in situ* preparation and characterisation tools that will allow the study of more sophisticated and pertinent structures. Furthermore, the combination of the isotopic probe-layer technique with the anticipated nanometric focusing capabilities, not only for depth but also for lateral mapping, will become accessible allowing the study of single nanoscale objects.

nanostructures at surfaces, interfaces, and in buried layers. This will require nanosized beams to be produced in combination with isolated nano-objects. This is challenging as it requires not only state-of-the-art photon beams but nanosample preparation and characterisation tools. Both this environment and nanobeams will become available within the framework of the Upgrade Programme. A Partnership for Surface Science would enable in-house and external expertise to be combined and the necessary resources to be optimised.

Furthermore, the density of phonon states is different in two orthogonal directions, such as [110] and [001] at the surface (Figure 1.1.8) (Slezak *et al.*, 2007). This is in line with simultaneous investigations by nuclear forward scattering, which probe the electronic and magnetic properties with the same sensitivity. A specialised infrastructure is needed to prepare such objects. It could then be envisaged to study individual

Surface dynamics

Understanding processes based on nanoclusters requires detailed information on the laws governing the dynamics of these systems. Nowadays, surface techniques based on synchrotron radiation provide important information on the time evolution of macroscopic properties, such as average dimensions,

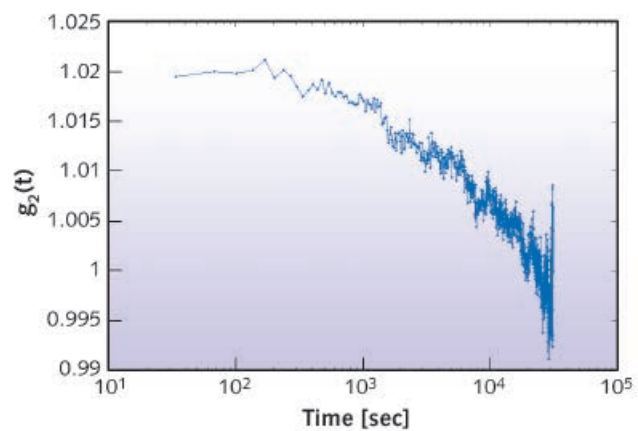
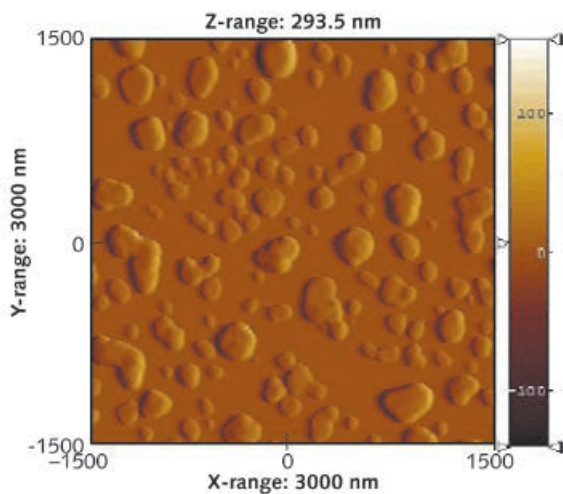

Figure 1.1.9: Left: A 6 nm thick nickel film on amorphous silicon oxide. After de-wetting at about 500°C, a coalescence of large nickel clusters is observed. Right: Time autocorrelation function of 10 nm nickel particles (data courtesy of C. Boragno and R. Felici, unpublished results). The combination of time-dependent surface small-angle scattering measurements together with photo correlation measurements allows the study of macroscopic and microscopic time-dependent phenomena such as those involving auto aggregation of metal particles. These phenomena are of fundamental importance in a variety of catalytic reactions.

correlation lengths or shape, *in situ* during the formation or the reaction. Coherent beams are still poorly used in these studies because of the lack of coherent beam intensity. X-ray photocorrelation spectroscopy (XPCS) has already been employed to provide information on the dynamics of liquid surfaces (Madsen *et al.*, 2004) and it can create new opportunities for elucidating the dynamic properties of nanoclusters at surfaces, including their diffusion properties (Figure 1.1.9). This is important for understanding the coalescence of the clusters, resulting in the formation of particles with increased dimensions and, generally, reduced reactivity. This type of study is a challenging task because it requires very stable beamline parameters such as beam flux and position. The flux is, moreover, crucial due to the limited number of scattering objects. Clusters at surfaces have dimensions of a few nanometres and densities of less than 10^8 mm^{-2} . In particular, the use of a pink beam monochromator will be essential in providing the incident flux necessary for studying the phenomena at realistic timescales.

Relevant Conceptual Design Reports:

- **CDI:** Coherent X-ray Diffraction Imaging and Microdiffraction
- **HXPM:** Hard X-ray Photoelectron Microscopy
- **NR-NSM:** Nuclear Resonance – Nanoscale Materials
- **SMILE:** Spectro-Microscopy and Imaging at Low Energies
- **SMS:** Resonant Soft X-ray Magnetic Scattering
- **SURF:** Surface Diffraction
- **XMAN:** X-ray Spectroscopy and Multi-Imaging Analysis

Key enabling technologies and infrastructures:

See end of chapter.

1.1.3. Soft condensed matter and biological systems

The development of nanobioscience as both a fundamental and applied science area has led to active research at the border between macromolecular crystallography and traditional soft matter science. The intrinsic nature of soft and biological materials calls for a hierarchical investigation as macroscopic function can only be understood if research on microscopic structure and dynamics over all length scales down to the molecular and atomic levels is undertaken.

As demonstrated by recent developments in scanning microdiffraction (Riekel, 2000), synchrotron radiation nanoprobe are unique in their potential impact on research. The combination of new high resolution imaging, spectromicroscopy, X-ray fluorescence and X-ray diffraction will significantly contribute to how the full picture of biological models is put together. Some illustrative examples are given in this section to emphasise the specific potential of nanobeams, although these subjects are described in detail in a dedicated chapter (1.2).

From microfluidics to nanofluidics

Microfluid technologies developed dramatically during the 1990s and applications in biology, chemistry, physics and engineering became routinely available. Microfluidics covers a wide range of technologies and methods that allow micro and nanolitre fluid volumes to be controlled. The development of labs-on-a-chip, for instance, has proved to be successful in performing high throughput biological assays and new chemical syntheses due to the incomparable control of fluid flows (short mixing times, well defined shear rates, high thermal transfers, etc.) that they offer.

Microfluidics also offers access to time-resolved studies of various processes taking place in mixing flow cells. Indeed, in such a system, the time dependence of the kinetic process triggered by mixing of the fluids is mapped into a space-dependent data set. This is an extremely powerful technique, as time-resolved information can be retrieved by performing quasi-stationary measurements at several locations along the direction of flow. The timescales investigated can be tuned with currently available microfluidic cells from a few milliseconds to a few hours by changing the flow rate (Pfohl *et al.*, 2003). Such experiments are thus well suited for X-ray techniques since it is possible to perform measurements of fast dynamic processes with long acquisition times, and with a continuously refilled sampling volume. X-ray-induced damage is therefore significantly reduced. Combined approaches will also profit from microfluid technology. The possibility of large-scale protein crystallisation studies using microfluidic chips could therefore find applications in crystallising large complexes or membrane proteins (Hansen and Quake, 2003). The possibility of rapidly assessing crystal quality by *in situ* scattering experiments also exists.

Recent developments in nanoscience and nanotechnology can naturally be extended towards nanofluidics for similar control of liquid flow and molecular behaviour at the nanoscale (Eijkel and Van den Berg, 2005). Micro and nanofluid technologies have the potential to revolutionise the X-ray studies of soft condensed matter. Ultra-fast mixing processes

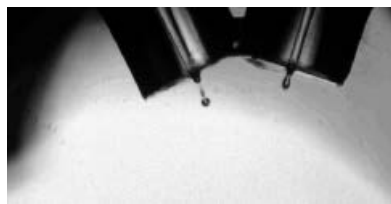

Figure 1.1.10: A mixing-droplet apparatus. The stroboscopic image shows the onset of ejection of 30 μm diameter water droplets from two piezo-driven inkjet heads at about 2 m/s velocity. The inkjet heads are aligned to allow fusion of the droplets in flight. The X-ray detection system has to be synchronised with the ejection of the droplets. Advances in nanofluidics, like the drop mixer, linked with a Soft Matter Partnership, will be essential for the proper development of innovative science in soft condensed matter.

will offer a powerful alternative to current stop-flow techniques. Using custom-made hydrodynamic focusing cells with a few micrometre-wide channels and nanometre sized beams would allow the microsecond timescale (Knight *et al.*, 1998) to be reached. The onset of protein conformational changes or beta-sheet to alpha-helix transitions could be studied (Kauffmann *et al.*, 2001) through the evolution of SAXS parameters, such as the radius of gyration. Nano(micro)fluidics also has promising applications in mimicking complex biological functions such as the control of the power stroke of artificial muscles through pH jumps (Geoghegan *et al.*, 2006). Mastering the technology of microfluidics will be one of the key challenges for the ESRF in order to obtain access to custom-made microfluid chips, microjets and microdrop generators for a large range of applications. A current example (Figure 1.1.10) can be found in a mixing-droplet apparatus, which makes possible microsecond time resolution in a stroboscopic experiment (Lee, 2003). The same equipment could also allow flash freezing techniques of mixing intermediates. Specific technical developments are required to integrate micro and nanofluid technology into nanofocus beamlines. Sample manipulators, such as optical tweezers, in fluidic environments will be one of the main challenges for the reproducible positioning of small biological objects or crystals in a micro or nanobeam. This will, for example, allow the radiation dose to be distributed over multiple samples during data collection in a pseudo-stroboscopic experiment. Related techniques are already available in cell-sorting microfluidics experiments. The creation of optical trap arrays by holographic techniques allows particle sorting and probing complex flow phenomena on the micrometre scale (Di Leonardo *et al.*, 2006).

Nanomedicine

The applications of nanotechnology in medicine are especially promising, and areas such as disease diagnosis, drug delivery targeted at specific sites in the body and molecular imaging are being investigated intensively. New materials and devices such as scaffolds for cell and tissue engineering and sensors are being designed in order to monitor various aspects of human health. Many of these applications are not envisaged for the next ten years or more, owing partly to the rigorous testing and validation protocols that will be required (Wagner *et al.*, 2006).

For example, an important part of these future developments involves metal-based nanomaterials (magnetic nanoparticles for magnetic resonance imaging, ZnO or CdSe quantum dots, TiO_2 , Au and Fe nanoparticles for cell targeting) (Michalet *et al.*, 2005). These nano-objects are of variable size from a few nanometres to a few hundred nanometres and can take the form of a nanoplatform holding hundreds of small molecules (Figure 1.1.11). Different sizes mean, however, different uptake routes in cells. Devices smaller than 50 nm can easily enter most cells and those smaller than 20 nm can transit out of blood vessels. Imaging will play an increasing role in understanding the characteristics of nanomaterials since it complements bulk measurement methods such as scattering and spectroscopy by providing location-specific information in heterogeneous systems.

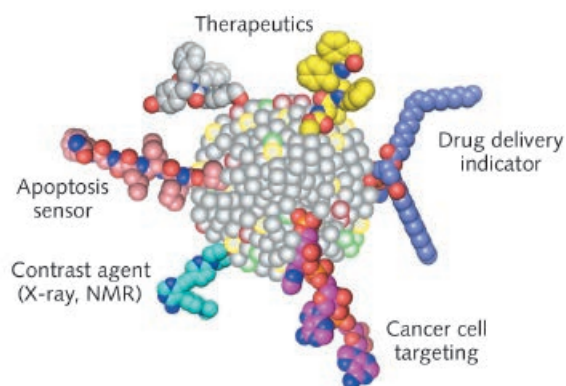

Figure 1.1.11: Dendrimers is one example of multifunctional nanotechnology-based devices for biological and medical investigations. The X-ray fluorescence nanoprobe planned in the Upgrade Programme will be essential tools that provide access to three key parameters on metals integrated into these devices, *i.e.* spatial distribution (localisation), concentration (dose), and chemical state (coordination).

Amongst several other techniques, the advent of the synchrotron nanoprobe as a multimodal nanoimaging tool is expected to play an important role in this field. An extensive development programme on cryopreservation of the sample during acquisition makes X-ray fluorescence nanoprobe suitable for

wider application. X-ray fluorescence nanoprobe appear to be a unique analytical technique with the spatial resolution to examine intact hydrated samples at the nanometre scale. This technique is capable of both imaging, and chemical determination and speciation. Several nanoprobe beamlines are proposed in the Upgrade Programme, offering a unique coupling between high-resolution/high detection efficiency/spectroscopy and giving access to the three key parameters: spatial distribution (localisation), concentration (dose) and chemical state (coordination), which must be systematically addressed in this science area. Amongst numerous possible applications (*see also section 1.5.2*), two specific examples are given below:

- *Nanomaterials and nanodevices for novel therapeutics and drug delivery systems*: Through the recent progress in multifunctional contrast agents for medical imaging, a number of new compounds have been produced that are directly responsive to biological activities. Efforts are being made to produce new diagnostic molecular imaging agents, but the most challenging part of this is delivering these multifunctional compounds to well identified targets. Multi-elemental X-ray fluorescence nanoprobe combined with ultra-fast frozen cell preparations will allow metals (iron, gadolinium, etc.) incorporated in these nanostructures to be detected and will yield critical data that can be used to streamline their design.
- *Toxicological considerations of nanomaterials*: The same unique physical and chemical properties that make nanomaterials so attractive may be associated with their potentially toxic effects on cells and tissues (Medina *et al.*, 2007). The existing and emerging uses of nanoscale materials have given rise to growing concerns about their unintentional health and environmental impacts. For instance, the metal oxide-based nanoparticles (TiO_2 , ZnO , Fe_3O_4 , Al_2O_3 , and CrO_3) and quantum dots mentioned above have a core made up of relatively toxic metals (Cd, Se, etc.). Ultrastructural X-ray imaging methods using synchrotron nanotomography coupled to elemental and speciation nanoanalysis will be particularly suited to studies on the interaction of nanomaterials with lung cells or other biological structures.

Relevant Conceptual Design Reports:

- **MINADIF**: Micro- and Nano-Diffraction
- **SFINX**: Scanning Fluorescence and Imaging at the Nanoscale using X-rays
- **SMILE**: Spectro-Microscopy and Imaging at Low Energies
- **XMAN**: X-ray Spectroscopy and Multi-Imaging Analysis

Key enabling technologies and infrastructures:

See end of chapter.

1.1.4. Hard materials at the nanometre scale

The sub-micrometre length scale represents a field in which fundamental challenges and opportunities in materials science are abundant. This length scale is at the frontier of current theoretical understanding as bulk models begin to fail due to growing surface/volume ratios. This is also at the limit of quantum events, and of current experimental techniques. Phenomena on this scale (such as dislocations, grain boundaries, etc.) determine basic materials properties such as hardness. The current models describing these properties are very approximate, as there has simply been no method available to probe bulk structure on the sub-micrometre scale.

It is therefore proposed to implement an array of techniques aimed at collecting both stochastic and spatially resolved information about materials structure and microstructure at the nanoscale. Using diffraction-based techniques, it is possible to map not only grain locations but also their orientations, strain state and chemical character. These are parameters of fundamental importance in determining long-range properties. Examples of applications are numerous: direct mapping experiments of devices such as electronic components with sub-100 nm features; studies of metals, alloys, oxides and other inorganic materials in order to determine their micro- and meso-structure; *in situ* experiments to follow. An example can be given of the growth curves of arrays of individual crystallites, which provide information about the heterogeneity of the processes. This information has been unavailable up until now and is crucial to the understanding of grain growth. The nanodomain is a key length scale in materials science, one that fits into a continuum of detail between the angstrom level (atomic structure) and the millimetre scale (the characteristic size of many samples). The tools that will be developed aim to characterise all of these length scales simultaneously, via total hierarchical characterisation, as discussed in [section 1.3.5](#).

Current techniques have made it possible to probe the nanoscale via stochastic methods, with which substantially smaller objects than the current spatial resolution can be detected and characterised. For example, growth curves of crystallites have traditionally been studied via ensemble methods, which only give average information and lead, necessarily, to the formation of homogeneous models. It is known, however, that crystal growth in a sample is not homogeneous, and that, indeed, these inhomogeneities are critical in the evolution of the sample. The methods being developed mean that the effects of differences in local environment, crystallite size, aspect, and orientation on crystallisation and

Reprinted from *Materials Today* 9(1-2), 18-25, D. Juul Jensen, E.M. Lauridsen, L. Margulies, H.F. Poulsen, S. Schmidt, H.O. Sørensen, C.B.M. Vaughan, X-ray microscopy in four dimensions, copyright 2006, with permission from Elsevier.

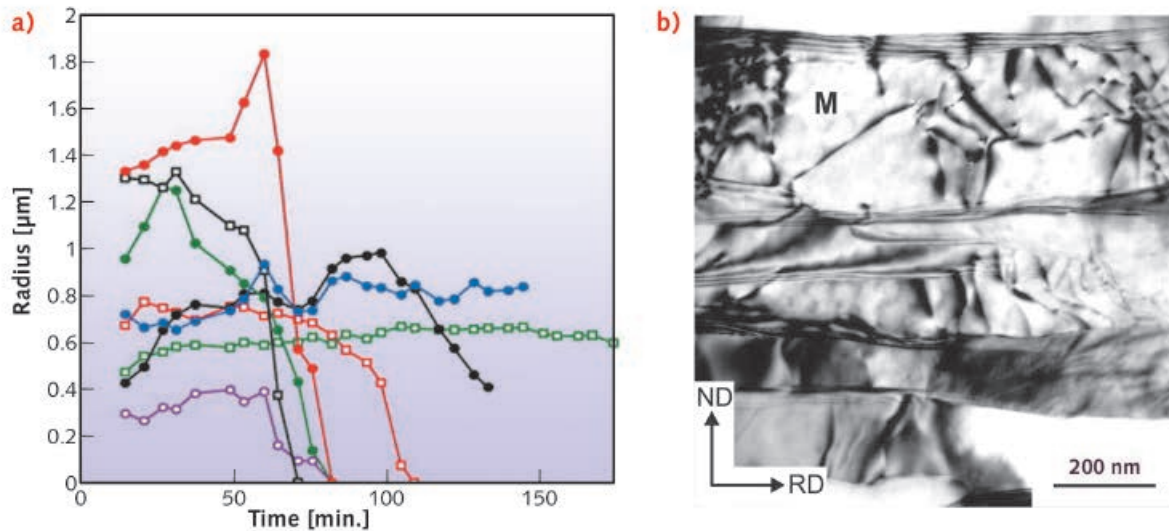

Figure 1.1.12: a) Growth curves for eight grains in 99.99% deformed aluminium during annealing at 175°C, illustrating the heterogeneous nature of crystal growth. This negates the belief that large grains grow whereas small grains disappear. b) Transmission electron micrograph of a structure within nanostructured aluminium. Technical developments of the ESRF Upgrade (combination of the 3DXRD method with high-energy nanofocusing) will make it possible to examine the detailed nanostructure of such materials and to characterise poorly understood but important aspects of early nanocrystallisation.

From X. Huang, N. Hansen, N. Tsuji, *Hardening by Annealing and Softening by Deformation in Nanostructured Metals*, *Science* 312, 249 - 251 (2006). Reprinted with permission from AAAS.

re-crystallisation can be seen. If these studies are pushed to the nanoscale, classical physics begins to collapse and material properties alter. This is suggested within the framework of the Upgrade Programme. In spite of great theoretical interest in these processes, there are still very little actual data probing this length scale. Examples showing the initial work at the nanoscale are presented in [Figures 1.1.12](#) and [1.1.13](#), which illustrate the inhomogeneity of the growth process in real samples, and the consequences on global properties, in this case the particle size distribution. In these experiments, grains of dimensions less than 100 nm could be characterised.

A plethora of other materials have important properties derived from the nanoscale characteristics. The modern electronics industry depends on features well below 100 nm. Optimised fabrication methods and the long-term stability of these materials have been determined in an essentially empirical manner up to now. This is obviously not ideal given the rapidly developing electronics industry. The use of nanodiffraction-based methods allows such features as the grain size, orientation or strain distribution in nanowires of electronic circuits to be characterised; these properties are crucial to chip performance.

A future challenge lies in complementing nanodiffraction with real space imaging techniques. Several methods for 3D imaging have been pioneered by the ESRF (see [chapter 2.2](#)) and will be further exploited with the use of nanobeams. Significant progress in the instrumentation and theoretical models has led to computed tomography,

laminography, phase-contrast microscopy and, more recently, coherent diffraction imaging. This constitutes a set of techniques of unique potential in materials science at the nanometre scale (see [section 1.3.5](#)).

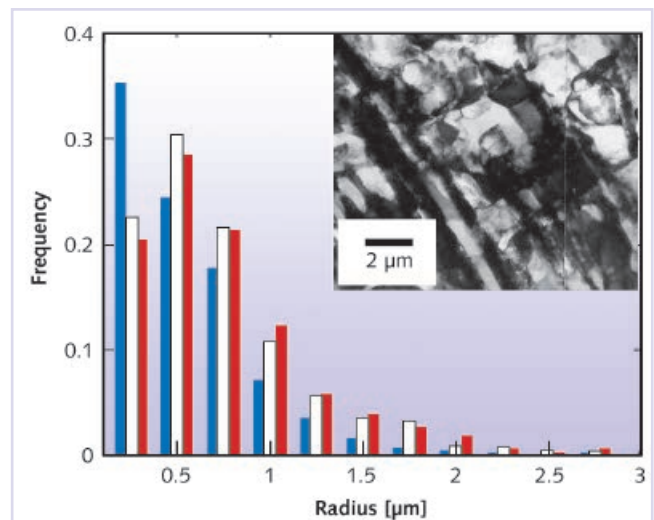
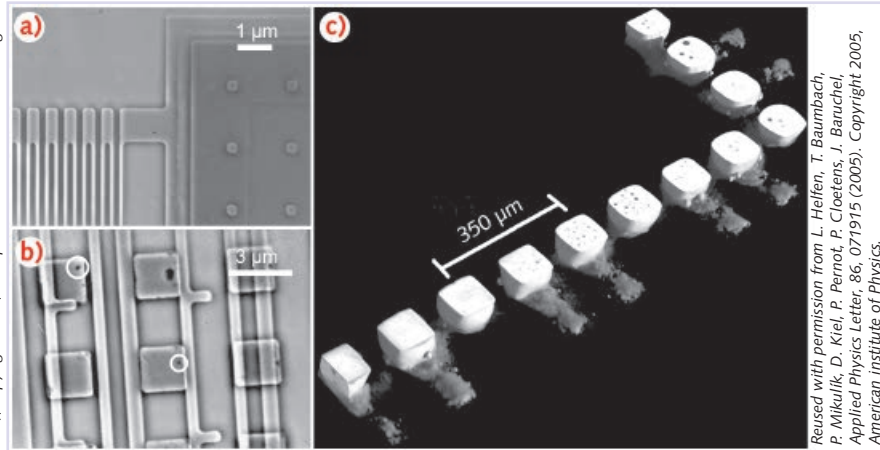

Figure 1.1.13: Recovery of 38% cold-rolled aluminium. Histograms of sub-grain domain sizes (equivalent spherical radii) obtained from 500 diffraction spots in the as-deformed state (blue) and after 3 min (white) and 181 min (red) of *in situ* annealing at 300°C. Inset: Transmission electron micrograph of the as-deformed material. Here resolution could be achieved down to ~250 nm; further improvement in high-energy nanofocusing and sample metrology will allow much smaller length scales to be characterised and nanocrystallisation to be studied.

Reprinted from *Scripta Materiala* 50 (8), 477-481, H.F. Poulsen, J.R. Bowen, C. Gundlach, *Direct Observation of subgrain evolution*, copyright 2004, with permission from Elsevier.



Reused with permission from L. Helfen, T. Baumbach, P. Mikulic, D. Kiel, P. Pernot, P. Cloetens, J. Baruchel, *Applied Physics Letter*, 86, 071915 (2005). Copyright 2005, American Institute of Physics.

Figure 1.1.14: a) Copper interconnect structures, imaged with the ID21 transmission X-ray microscope in positive phase contrast (spatial resolution 60 nm). b) Defects within a conducting copper line (white circles) that could be a nucleation site for electromigration. c) 3D rendition of solder bumps of a flip-chip device on a printed circuit board. Internal voids affecting the reliability of the device can be seen on the right-hand side. The Upgrade will take imaging to high spatial resolution with routine operation of 20 nm beams.

An illustrative case is state-of-the-art microprocessors, which require the integration of billions of transistors that have to be connected by metal interconnects with line widths down to 100 nm and below. As the number of devices increases and the feature sizes become smaller, the speed of microprocessors is increasingly determined by interconnection design, technology and materials. Whilst the dimensions of the interconnections continue to shrink, the formation of voids in interconnections induced by high current densities (electro-migration) during operation can cause an open circuit or an increase in resistance, resulting in malfunction or speed degradation. In addition, copper is increasingly being employed as an interconnection material due to its higher conductivity and better resistance against electro-migration failure. Copper interconnects have to be encapsulated with special metallic or dielectric barriers to prevent copper diffusion into the silicon, as it does not form an adherent oxide diffusion barrier like aluminium. Therefore, the interfaces between copper and the surrounding barriers could be an easy electro-migration pathway, and interface or surface diffusion may be very important for the electro-migration behaviour of a copper multilevel metallisation system.

New methods are needed for rapid direct and *in situ* visualisation. High spatial resolution analysis is a key issue when penetrating through several micrometres of dielectrics. Surface-sensitive techniques, such as atomic force microscopy or scanning electron microscopy, either require destructive sample preparation or provide only a limited resolution due to electron scattering in thick passivation layers. The high penetration depth of hard X-rays, on the other hand, allows hidden structures such as solder joints to be imaged, which are encapsulated or obstructed by the electrical component itself and thus are not accessible by traditional visual inspection methods (Figure 1.1.14). Ultimately, these non-destructive methods can be envisaged in *quasi* real time.

Due to a lack of quantitative characterisation of various key parameters, the optimisation strategy for microprocessor design and fabrication is primarily based on empirical knowledge. Importantly, although the best initial parameters can be determined, there is no real understanding of phenomena effecting long-term operation and ageing of microelectronic components which are expected to have ten-year lifetimes. Although electron microscopy is commonly used to study such phenomena the very limited penetration probe depth implies time consuming and sophisticated sample preparation and thus prevents *in situ* measurements. X-ray based nanoprobe will complement the traditional methods by offering measurements of the strain, texture, and chemical heterogeneity in embedded copper features using nanodiffraction techniques (see chapter 2.2). This type of information will allow a better control of the long-term reliability of microelectronic components.

Relevant Conceptual Design Reports:

- IMPACT: Imaging using Parallel Beam and Computed Tomography
- MATSCI: Materials Science
- SFINX: Scanning Fluorescence and Imaging at the Nanoscale using X-rays
- XMAN: X-ray Spectroscopy and Multi-Imaging Analysis

Key enabling technologies and infrastructures:

See end of chapter.

1.1.5. A platform for nanoanalysis

A coherent scientific and methodological development of new nanofocus beamlines will be technically challenging in a number of ways. Specific developments will need to be made in sample

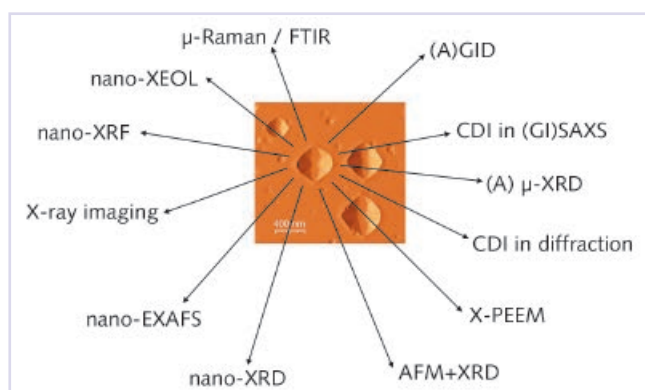

Figure 1.1.15: The Upgrade Programme infrastructure will require a coordinated development of various beamline instruments which, if applied to the same object, would constitute a unique analysis platform. This synergy will be essential in developing specific effective and productive scientific projects involving expert teams and science-driven collaborations.

handling, in addition to the standard but very complex requirements associated with optics, mechanical and thermal stability. Maximising the unique potential of X-ray nanoprobe to perform *in situ* characterisation will require innovative strategies for nano-object manipulation. These will be carried out in highly controlled sample environments customised for the specific problem under investigation. Ultimately, these nanoprobe instruments will rely on a very high level of integration, in which optics, detectors, sample positioning and visualisation systems, will no longer be independent components, but integrated into a common, dynamic instrument framework.

Creating a Technical Platform for Nanoanalysis will be a highly effective way of encouraging continuous scientific development and making sure that nanoprobe beamlines are used in the optimum manner. This facility is expected to create new opportunities for research and development in optics, sample environment and analytical techniques. The following points should be specifically noted:

i) It will provide specific nanoengineering expertise based on both our long standing experience in beamline design and the analysis of new solutions offered by industrial developments in nanoengineering. Integration will be a key issue of this programme and requires various aspects of a given project to be coordinated carefully (Figure 1.1.15). It is worth noting that the proposed strategy has been created by taking into account well established experience. The first steps in developing suitable nanoscience instrumentation have already been initiated by the ESRF through several pilot upgrade projects: ID11, ID13 (nanodiffraction) and ID22 (nanoimaging). The technological development of these pilot projects is currently coordinated by a

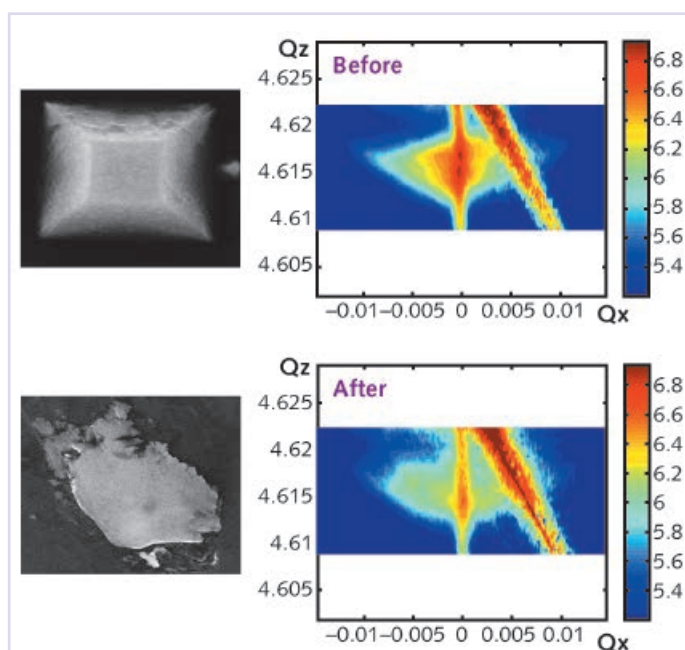

Figure 1.1.16: An *in situ* AFM installed on a diffractometer can serve two purposes: 1) To place nanostructures in the X-ray beam focus. These are too small to be resolved by an optical microscope; 2) To use the AFM tip to manipulate nanostructures. The figures show a first (destructive) attempt at a nanoindentation on a germanium pyramid and the resulting change in the reciprocal space map measured *in situ*, close to the (004) Bragg peak. This kind of setup will become a tool for *in situ* studies of nanotribology and/or elasticity of structures on the nanoscale in a (sub)-micrometre focused X-ray beam.

Nanotechnology Platform, which was created in 2006. This platform, involving both beamline scientists and engineers, is, in particular, exploring all of the engineering issues which will have to be carefully addressed for the new nanoprobe beamlines. This will be undertaken through in-depth technical assessments of the current projects. These upstream activities are expected to provide a very strong technological background and the essential expertise and know-how for future projects.

ii) It will offer a technology platform for sample handling with a particular focus on integrating scanning probe microscopes (SPM) into beamline instruments. SPMs (AFM, STM) are extensively used in nanotechnology to visualise and manipulate samples of nanometre size, but their application in real time under X-ray beams is still underexploited. The reduced size of SPMs and their rather low cost make them ideal for use on beamlines, providing new tools for visualising, positioning and manipulating nanometre sized samples. The ESRF pioneered this kind of development in coupling SPMs and synchrotron instruments (*e.g.* X-TIP, see Figure 1.1.16). The accumulated expertise will be applied to new projects.

iii) It will coordinate the development and operation of a characterisation and preparation laboratory. An increasing number of experiments on beamlines will require pre-characterisation and specific sample preparation protocols. Basic equipment such as electron and light microscopes, SPMs, FIB, and laser cutting will be required in surface and materials sciences, soft matter and biology (Figure 1.1.17). This expensive equipment will require specific skills if it is to be operated efficiently. Consequently such resources will be centralised and shared between the different beamlines.

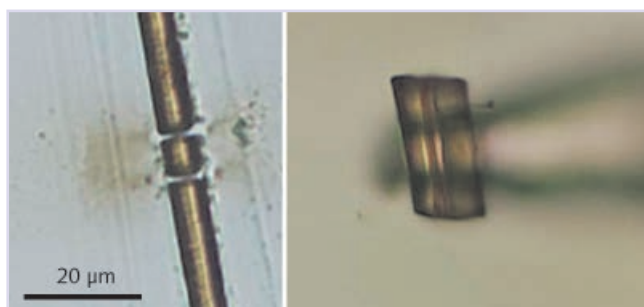

Figure 1.1.17: Section of a Kevlar fibre cut with a laser microdissection system (left). The sample is then fixed on a capillary tip (right). Ancillary preparation equipment such as a laser ablation system or focused ion beam (FIB) will be of prime importance for proper development of the nanoscience programme in the Upgrade.

iv) It will be an efficient research and development platform for new science-driven projects using combined techniques (imaging, diffraction and spectroscopy). This proposed collaboration between highly specialised beamlines will be an exclusive advantage of the project. It will rely on good coordination between the different beamlines for a given science programme. It will be ensured, for example, that sample handling strategies are made compatible between the different beamlines involved in a specific programme.

v) Finally, on a more general level, a partnership will be created with external laboratories specialised in nanotechnologies and nanoanalytical tools. This will provide the foundations necessary to develop effective and productive science-driven collaborations around specific scientific projects. New networking and outsourcing strategies will then be created.

In conclusion, the Upgrade Programme will allow a Technical Platform for Nanoanalysis to be created through construction of satellite laboratories and dedicated infrastructure. This platform will constitute a unique analytical platform, even on a worldwide level, by providing coordinated access to various beamlines and laboratory instruments. These new resources will have an impact not only in nanoscience

activities but will also benefit the other science and technology areas proposed within the framework of the Upgrade Programme.

Key enabling technologies and infrastructures for science at the nanometre scale:

- New buildings for long beamlines and space for new, dedicated infrastructure.
- A dedicated infrastructure for sample preparation and handling is crucial for the full exploitation of nanoprobe and associated user-driven scientific programmes.
- Detectors: diffraction and imaging experiments will rely on the development of new detectors.
- Nanocompatible engineering and technology (e.g. optics, high precision components) and software (e.g. specialised ray tracing).

References

- Di Leonardo R., Leach J., Mushfique H., Cooper J.M., Ruocco G., and Padgett M.J. (2006), Multipoint holographic optical velocimetry in multi-fluidic systems, *Phys. Rev. Lett.*, **96**, 134502-1-4.
- Eijkel J.C.T. and Van den Berg A. (2005), Nanofluidics: what is it and what can we expect from it?, *Microfluid. Nanofluid.*, **1**, 249-267.
- *European White Book on Fundamental Research in Materials Science* (2005). Stuttgart: Max-Planck-Institut Für Metallforschung.
- Geoghegan M., Ruiz-Pérez L., Dang C.C., Parnell A.J., Martin S.J., Howse J.R., Jones R.A.L., Golestanian R., Topham P.D., Crook C.J., Ryan A.J., Sivia D.S., Webster J.R.P., and Menelle A. (2006), The pH-induced swelling and collapse of a polybase brush synthesized by atom transfer radical polymerization, *Soft Matter*, **2**, 1076-1080.
- Gundlach C., Pantleon W., Lauridsen E.M., Margulies L., Doherty R.D., and Poulsen H.F. (2004), Direct observation of subgrain evolution during recovery of cold-rolled aluminium, *Scripta Mater.*, **50**, 477-481.
- Hansen C. and Quake S.R. (2003), Microfluidics in structural biology: smaller, faster... better, *Curr. Opin. Struct. Biol.*, **13**, 538-544.
- Helfen L., Baumbach T., Mikulík P., Kiel D., Pernot P., Cloetens P., and Baruchel J. (2005), High-resolution three-dimensional imaging of flat objects by synchrotron-radiation computed laminography, *Appl. Phys. Lett.*, **86**, 071915.
- Juul Jensen D., Lauridsen E.M., Margulies L., Poulsen H.F., Schmidt S., Soerensen H.O., and Vaughan G.B.M. (2006), X-Ray microscopy in 4 dimensions, *Mater. Today*, **9**(12), 18-25.
- Kauffmann E., Darnton N.C., Austin R.H., Batt C., and Gerwert K. (2001), Lifetime of intermediates in the beta-sheet to alpha-helix transition of beta-lactoglobulin by using a diffusional IR mixer, *Proc. Natl. Acad. Sci. USA*, **98**(12), 6646-6649.
- Knight J.B., Vishwanath A., Brody J.P., and Austin R.H. (1998), Hydrodynamic focusing on a silicon chip: mixing

nanoliters in microseconds, *Phys. Rev. Lett.*, **80**(17), 3863-3866.

- Lee E.R. (2003), *Microdrop Generation*, CRC Press, Boca Raton, FL.
- Lee T.-L., Joumard I., Zegenhagen J., Schoch W., and Brandt M. (2006), X-ray standing wave imaging of Mn in GaAs, *ESRF Highlights 2006*, 75-76.
- Livet F. (2007), Diffraction with a coherent X-ray beam: dynamics and imaging, *Acta Crystallogr.*, **A63**, 87-107.
- Madsen A., Seydel T., Sprung M., Gutt C., Tolan M., and Grübel G. (2004), Capillary waves at the transition from propagating to overdamped behavior, *Phys. Rev. Lett.*, **92**, 096104.
- Martinez-Criado G., Alen B., Homs A., Somogyi A., Miskys C., Susini J., Pereira Lachataigneris J., and Martinez-Pastor J. (2006), Scanning X-ray excited optical luminescence microscopy in GaN, *Appl. Phys. Lett.*, **89**, 221913.
- Medina C., Santos-Martinez M.J., Radomski A., Corrigan O.I., and Radomski M.W. (2007), Nanoparticles: pharmacological and toxicological significance, *Br. J. Pharmacol.*, **150**(5), 552-558.
- Michalet X., Pinaud F.F., Bentolila L.A., Tsay J.M., Doose S., Li J.J., Sundaresan G., Wu A.M., Gambhir S.S., and Weiss S. (2005), Quantum dots for live cells, in vivo imaging, and diagnostics, *Science*, **307**, 538-544.
- Neuhaeusler U., Schneider G., Ludwig W., Meyer M.A., Zschech E., and Hambach D. (2003), X-ray microscopy in Zernike phase contrast mode at 4 keV photon energy with 60nm resolution, *J. Phys. D: Appl. Phys.*, **36**, A79-A82.
- Pfohl T., Mugele F., Seeman R., and Herminghaus S. (2003), Trends in microfluidics with complex fluids, *Chem. Phys. Chem.*, **4**(12), 1291-1298.
- Riekel C. (2000), New avenues in X-ray microbeam experiments, *Rep. Prog. Phys.*, **63**, 233-262.
- Rusponi S., Cren T., Weiss N., Epple M., Bulushek P., Claude L., and Brune H. (2003), The remarkable difference between surface and step atoms in the magnetic anisotropy of two-dimensional nanostructures, *Nat. Mater.*, **2**, 546.
- Slezak T., Lazewski J., Stankov S., Parlinski K., Reitinger R., Rennhofer M., Ruffer R., Sepiol B., Slezak M., Spiridis N., Zajac M., Chumakov A.I., and Korecki J. (2007), Phonons at the Fe(110) surface, *Phys. Rev. Lett.*, **99**, 066103.
- Wagner V., Dullaart A., Bock A.K., and Zweck A. (2006), The emerging nanomedicine landscape, *Nat. Biotechnol.*, **24**(10), 1211-1217.
- Yasufuku H., Yoshikawa H., Kimura M., Vlaicu A.M., Kato M., Kudo M., Fujikata J., and Fukushima S. (2006), On the wide-energy-range tuning of X-ray photoemission electron microscope optics for the observation of the photoelectrons excited by several keV X-rays, *Rev. Sci. Instrum.*, **77**, 033702-1-5.
- Zegenhagen J. (2005), Proceedings of the Workshop on Hard X-ray Photoelectron Spectroscopy – HAXPES, J. Zegenhagen and C. Kunz (editors), *Nucl. Instrum. Methods Phys. Res. A*, 547(1).
- Zhang P., Kim P.S., and Sham P.S. (2002),

Nanostructured CdS prepared on porous silicon substrate: Structure, electronic, and optical properties, *J. Appl. Phys.*, **91**, 6038.

1.2. Structural and functional biology, soft matter

Science context

The 21st century has been described as the century of biology, following the 20th century of physics. The vast amount of genomic information being produced is just starting to be exploited and, with the concurrent developments in molecular biology and biophysical analytical techniques, the coming years will continue to see unparalleled progress in the biological sciences. At the heart of understanding how life works is the knowledge of the structure and organisation of life's molecules at various levels of detail: from the atomic resolution only uncovered in macromolecular crystallography through the protein-complex level revealed in small angle X-ray scattering to the sub-micron level of modern day X-ray imaging. The information provided by these techniques is complementary and high quality synchrotron light and beamlines are absolutely critical to their current and future success.

Complex systems such as large macromolecular complexes, biopolymers, self-assembled nanomaterials, biomimetic systems and interfaces require multidisciplinary approaches for their structures to be revealed and their functionality to be understood. X-ray-based techniques play a central role in obtaining this information which helps in developing new drugs, in understanding diseases and viruses as well as improving the understanding of molecular machines through all hierarchical levels.

X-ray based soft-matter studies provide essential information on the behaviour of materials that play key roles in everyday life. Broad spatial and time ranges are essential to allow full characterisation and understanding of these materials, especially in the cross-over from mesoscopic to macroscopic behaviour. The microstructure and dynamics of complex and out-of-equilibrium systems (such as polymer processing) continues to generate new scientific challenges and quantitative X-ray scattering experiments will be essential to resolve these issues. Exploring the pathways of self-assembly of hierarchical systems and understanding the role of competing interactions and the complexities that lie beyond the hierarchical structures will be key to engineering new materials.

Added value of the Upgrade

The Upgrade Programme will provide the integration of many different techniques to study much more complex biological and soft-matter systems at both the functional and hierarchical level. The study of biological systems outside macromolecular crystallography is a key element of an integrated view of biology in action. It enhances the cross-fertilisation between biological and soft-matter science, and will open new possibilities to study self-assembled soft-matter and biological systems.

More specifically, science will benefit from:

- Access to smaller sample volumes, larger length and shorter timescales by building optimised beamlines and sample environments and making use of the unique filling modes of the ESRF storage ring.
- Broadening of the spatial and time ranges that can be probed by synchrotron radiation.
- Convergence of scattering and imaging techniques.
- Linked development and delivery of SAXS (X-ray at ESRF) and SANS (neutrons at ILL) techniques to a wider community.
- Development of new experimental tools to handle nanoscale samples will revolutionise sample manipulation of fragile biological and soft-matter samples. New and optimal ways to handle radiation damage will also be exploited.
- Construction of a beamline dedicated to the imaging of large-scale biological assemblies such as cells, virus particles and large molecular assemblies.
- Reconstitution of the macromolecular crystallography beamlines as a "village" of closely co-located and linked facilities with access made possible by remote control. Central to this proposal will be a dedicated sample screening facility to identify those samples out of the thousands tested that are suitable for redistribution to specialised MX beamlines for optimised data collection.
- Regrouping soft condensed matter beamlines as a "village" with linked or shared facilities. This will foster interactions between soft condensed matter beamlines and facilitate the establishment of partnerships. In particular, proximity to the MX village will allow expansion of the interface with biological sciences.

Key questions

The ESRF Upgrade will provide the infrastructure for cutting edge multi-disciplinary research in life sciences and soft matter to answer questions such as:

1. What is the structure, function and organisation of complex biological machinery?
2. What are the causes of human disease and how can disease be better treated?
3. How are biological systems hierarchically organised from atoms to micrometres?
4. How do complex fluids flow in confined geometries? For example: How can tertiary oil recovery from microporous rocks be optimised?
5. How can defect free nano-templates be fabricated?
6. What are the relationships between the mesoscopic structure and macroscopic properties of soft matter?
7. What are the kinetic pathways of natural and synthetic material self assembly?

The ensemble of changes proposed will make possible the study of currently inaccessible problems within the fields of structural and inaccessible biology and soft matter. The new infrastructures will thus enable significant advances in the creation of knowledge and wealth within the European Community.

Expected user communities

The study of the scientific disciplines of structural and functional biology, and soft matter unites chemists, physicists and biologists with materials and chemical engineers in the investigation of the underlying properties of complex systems. Macromolecular crystallography (MX) will continue to draw from the expanding European MX community providing facilities for both academic and commercial laboratories. The use of multi-disciplinary techniques to reveal the hierarchical nature of biological and soft matter requires multi-disciplinary teams using a number of different beamlines. The ESRF Upgrade will stimulate growth in the field by enabling new experiments and by providing supporting infrastructures and partnerships. In addition, it will provide the access methods necessary to promote multi-disciplinary synchrotron research for biologists.

Enabling technology and infrastructure

- *Buildings and infrastructure:* Several long beamlines are planned. Optimal use of the MX facilities implies

close co-location of the beamlines with sample "warehouses" for effective beamline operation. Closer physical links with the soft condensed matter beamlines will enhance collaboration and cross-fertilisation. Laboratory facilities and sample preparation space will extend soft and fragile condensed matter science.

- *Accelerator and source:* The increased photon flux and brilliance will benefit both areas by allowing the use of parallel end-stations served by one sector with canted undulators.

- *Beamlines and instrumentation:* The following developments are required: high sensitivity, large area detectors together with extended dynamic range and faster framing rates; specialised detectors for ultrafast framing and energy resolution; X-ray optics producing beams down to a few nanometres across; highly integrated mechanical and optical apparatus for nanofocus applications; nanosample handling techniques, such as microfluidics and optical tweezers, instrumentation for sample positioning and ways to minimise radiation damage.

- *Computing:* The programmes will require higher data storage capacity and archiving possibilities and continuous development of the automation framework and online data analysis. Theory and modelling are important backing for this scientific area.

Partnerships

The Partnership for Structural Biology (partners: ESRF, ILL, EMBL, IBS) provides a focus for structural biology. A similar new science-driven partnership in soft condensed matter is planned. The ESRF is implicated in many EU Framework Programme projects, for example: SPINE2, Bioxhit, Saxier, and the Centre for Integrated Structural Biology.

Industry and technology transfer

Pharmaceutical companies will continue to use MX facilities for lead development and this is expected to remain a major source of the industrial income for the ESRF. Production of equipment developed for the MX beamlines (*e.g.* sample changer, high precision diffractometer) has been licensed to industry. High brilliance SAXS/WAXS is used by industry to resolve certain critical problems related to formulation and kinetic effects undermining the shelf-life of personal care and pharmaceutical products.

1.2.1. Introduction

The study of complex systems requires a multi-disciplinary approach in order to provide as full a picture as possible.

A combination of complementary high- and low-resolution techniques is required in order to fully understand highly complex, multi-component biological systems (Abad-Zapatero, 2007). Synchrotron-based facilities, both current and planned, will play a major role in this regard. This chapter outlines those that will be created at the ESRF as part of the Upgrade. However, the ESRF cannot develop such facilities in isolation. Advanced studies of biological systems require specialised laboratories and long-term collaborations with external partners. The development of adequate laboratory facilities, which also allow partnerships to be hosted, will become crucial for the future of cutting-edge biological science at the ESRF. Interaction with the joint ESRF-ILL theory group will also be essential to share knowledge on complex biological processes such as protein folding or particle dynamics in a microfluidic environment.

The soft and fragile matter section of this chapter deals with relatively complex systems, which share certain physico-chemical characteristics of model biological systems. These complex systems also have attributes similar to those involved in hard condensed matter physics. Conventionally, soft-matter systems are characterised by a microstructure, delicate energetics and the strong influence of thermal fluctuations leading to their macroscopic softness. The complexity arises directly from these defining properties and their response to external fields. For instance, a subtle interplay between packing effects and external deformation or short-range attraction can transform certain systems to an out-of-equilibrium state with glass-like features. These kinetically arrested states form a new class of fragile materials which is closely associated with soft matter (Cates and Evans, 2000). These systems also mimic the crowding present in certain biological environments.

A major challenge for the science described in this chapter will be the handling of issues related to the damage caused to the sample by exposure to X-rays. Radiation damage remains a significant problem and must be tackled if the full potential of the ESRF Upgrade Programme is to be achieved. For MX, the problem is alleviated by the expedient of cryo-cooling the sample during the diffraction experiment. However, even when maintained at 100 K, most samples show significant deterioration resulting from X-ray exposure. The ESRF is at the forefront of research into this problem and further efforts will be needed. For soft condensed matter research, the problem is trickier because samples must be

maintained in specific thermodynamic states within a confined experimental configuration. Dealing with radiation damage will thus remain a topic of active research.

This chapter covers a very broad range of synchrotron technology and experimental science showing how complex biological and soft-matter systems may be studied. Approaches, such as small- and wide-angle X-ray scattering (SAXS/WAXS) techniques, that look at whole systems provide low or, at best, pseudo-atomic resolution models of biological systems and allow *in situ* studies of out-of-equilibrium processes. Grazing-incidence techniques, currently limited to model systems, provide structural information on biological surfaces such as membranes. Reducing the beam size to the nanoscale will provide opportunities for studying the surfaces of objects such as single cells. Coherent diffraction imaging with nanometre spatial resolution will provide a new window for visualising hierarchically organised structures and an extra tool complementary to those offered by electron microscopy and visible light microscopy. In contrast to these relatively low resolution methods, the approach currently used in structural biology provides atomic level precision to address questions of biological function. This is done by refining the crystal structures of macromolecules of interest, often as components of systems, to near-atomic resolution.

1.2.2. Structural and functional biology

Over the last 20 years, macromolecular crystallography (MX) has become the predominant tool used for the investigation of structure/function relationships in biology. This is the result of numerous technological improvements and, in particular, regular access to third-generation synchrotron sources. These have produced data which have led to around 80% of the macromolecular crystal structures currently deposited in the Protein Data Bank (PDB) (Figure 1.2.1, <http://www.rcsb.org>). The demand for synchrotron beam time is also being influenced by the funding of a number of structural genomics programmes (Norvell and Machalek, 2000 and references therein) which, following an initial investment in protein production technology, have now contributed approximately 1000 new structures to the PDB. The current, unprecedented demand for MX beam time and the need to support high-throughput experiments at high intensity with high accuracy has led to the development of automated sample changers and data collection facilities (Cipriani *et al.*, 2006; Beteva *et al.*, 2006). These facilities, coupled with an unrivalled level of user support, mean that the scientific output of the ESRF MX beamlines is unrivalled. In order to maintain this position as world-leader within this field, areas in

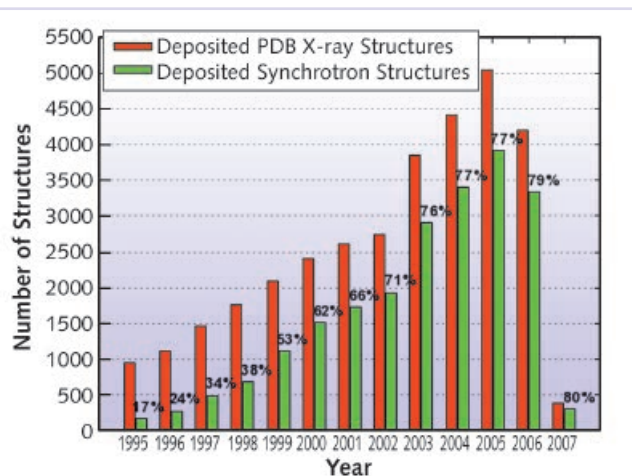

Figure 1.2.1: The growth of structures based on synchrotron collected diffraction data being deposited in the PDB. In 2006, synchrotron data accounted for nearly 80% of all deposited X-ray structures.

which the ESRF will invest in the near future are outlined below.

Large macromolecular complexes

Over the past decade, it has become apparent that cells are more than collections of individual macromolecules (Alberts, 1998). Whilst single proteins can catalyse biochemical reactions, it has now become clear that many proteins function as part of large macromolecular complexes and that higher cellular functions depend on carefully orchestrated protein interaction networks. These cellular networks are organised in a hierarchical manner and are extremely carefully regulated to allow proper functioning of the cell. Some of these macromolecular assemblies are tightly integrated and withstand isolation and purification. Others, however, exist only transiently; often they are variable in composition and undergo remodelling in response to specific signals. Here, the challenge for the structural biologist is to isolate or reconstitute such modules in a physiologically relevant configuration and under conditions amenable to structural studies. However, crystals of such complexes typically have variable quality and result in low resolution diffraction data. Studying these systems using crystallography will therefore require the diffraction properties of very many samples to be screened before an appropriate data collection can be made. However, it may be years before high-resolution diffraction is observed and many alternative complementary techniques will also be required so that the system of interest can be understood. An example of a complementary technique can be found in cryo-electron microscopy.

This technique has provided many useful insights into supramolecular organisation since, when combined with high-resolution crystal structures of the individual component parts of a complex, the low resolution provided by Cryo-Electron-Microscopy can allow the elucidation of interactions between the different subunits of the complex (Figure 1.2.2). However, the incorporation of atomic resolution sub-component structures into low-resolution envelopes means that significant overlap is required between the data available from the two techniques. In these cases, the collection of very low-resolution diffraction data (to allow significant overlap with cryo-electron microscopy) should be obtainable from poor quality, weakly diffracting macromolecular-complex crystals, whilst, at the same time, the collection of atomic, or near-atomic resolution data should be possible from crystals of the complex's component parts. Both scientifically and technically speaking, this represents a real challenge.

Membrane proteins, often part of large complexes (*cf.* Amunts *et al.*, 2007), perform a huge range of biological functions, including respiration, signal transduction and membrane transport. They are therefore important drug targets. An analysis of genome sequences indicates that up to 30% of the proteins encoded in eukaryotic cells are membrane proteins. More biochemists are developing an interest in membrane proteins and, alongside crystallographers, a wide range of these are now being studied. As a result, the number of membrane protein crystal structures determined has increased significantly over the past few years. Nonetheless, structure determination of membrane proteins remains challenging. It is often difficult to obtain purified samples in large quantities. In many cases, modern molecular biology tools (*i.e.* selenomethionine incorporation) cannot be used and researchers must exploit metal ions or other scatterers intrinsic to the protein if phases are to be developed in order to reveal its three-dimensional structure. This latter aspect usually requires data collection at longer wavelengths (around 1.6 to 2.3 Å) as well as careful experimental design. This approach also requires the careful monitoring of the potential photoreduction of the metal centres (this is true for any metallo-protein) and the complementary use of X-ray diffraction with other spectroscopic techniques is called for. The study of the dynamics of intact biological membranes awaits further experimental developments and lies within the scope of developments proposed later in this report (Section 1.2.3).

Protein-ligand interactions

Medicinal chemistry is also a field ripe with possibilities for the development of new life-saving drugs. Rational drug design has advanced enormously

Reprinted from *Journal of Molecular Biology* 367(2), J.A. Márquez, E. Galfre, F. Dupeux, D. Flot, O. Moran and N. Dimasi. The Crystal Structure of the Extracellular Domain of the Inhibitor Receptor Expressed on Myeloid Cells (PDB-1-370-318, copyright 2007, with permission from Elsevier.

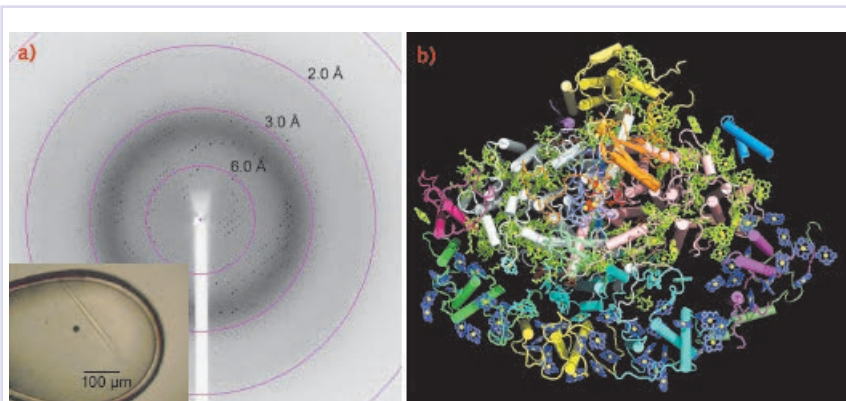

courtesy N. Nelson, Tel Aviv University.

Figure 1.2.2: (a) Crystals and associated diffraction patterns achievable from tiny macromolecular crystals (Márquez *et al.*, 2007); (b) The structure of a plant photosystem I supercomplex at 3.4 Å resolution, obtained from microcrystals and data collected on ID23-2 (Amunts *et al.*, 2007). The Upgrade will make data collection routine from crystals such as these and smaller. Special techniques will be developed for sample support, location and centring to handle the micrometre sized “crystals” expected in the future.

over the past decades, in particular due to the use of tools such as high-throughput X-ray crystallography and structural biology. There are still, however, huge technical challenges and a more accurate understanding of protein structures could lead to drug molecules being designed to attack particularly susceptible, or favourable, sites in protein–protein complexes. The role of protein crystallography in the drug discovery cycle has also changed dramatically over the last ten years. As novel structures can now be solved on shorter timescales than were possible before the availability of automated third-generation beamlines, the use of structural biology has become mandatory in the earliest stages of drug discovery, lead compound identification and optimisation. The same advances that led to the reduction in the time required for *de novo* structure determination have also dramatically decreased the time needed for the resolution of protein–ligand structures. This has resulted in novel, fragment-based drug design approaches and the use of structure-based combinatorial chemistry. The appropriate use of automation in this area will remain a major factor in maintaining European competitiveness in an area that should remain a significant European wealth generation asset for years to come. Vaccine development has yet to fully explore the advantages of a structure-based approach. However, even though the interplay between an antigen and the immune system is more complex than the interplay between a drug and its protein target, there will be benefits in extending rational drug design to cover this aspect in the future.

Microcrystal diffraction experiments

For some proteins crystallisation experiments will only ever produce extremely tiny crystals. Optimising data collection from such microcrystals will remain a significant challenge for the foreseeable future. However, pioneering work undertaken at the ESRF allows us to be confident that the technological challenges associated with these samples are surmountable and can be accommodated within an

experimental setup compatible with the highly-automated environment needed for MX (Figure 1.2.2). Nevertheless, if experiments with microcrystals are to achieve their ultimate potential, there is a need for tight integration between “demonstration of principle” experiments on adaptable nano- and micro-focusing facilities and the more prosaic “real-world” requirements for dedicated facilities. It is expected that a number of interesting opportunities, for example the blurring of boundaries between diffraction and scattering, will emerge from this work as X-ray beam sizes tend towards the size of the macromolecules themselves, providing overlap with work described in section 1.2.3.

Experiment automation for challenging problems

It should be remembered that the collection of suitable diffraction data is merely the first step towards elucidating the three-dimensional structure of a biomolecule. The key factor in *de novo* structure determination lies in producing phases to use in the calculation of the Fourier transforms that reveal the electron density distribution of the biomolecules in the crystal. This potentially difficult process has been transformed by the availability of automated, intense and reliable MX beamlines. The variation of photon energy and the tuning of an experiment to precisely the correct energy (with sub-electronvolt accuracy) have been vital in providing the experimental power needed to drive the explosion of structural biology. Key to the use of the anomalous dispersion technique, where the “signal” is usually of the order of a few percent of the measured amplitude, has been the ability to collect extremely accurate structure factor amplitudes. Such measurements have benefited from instrumentation developments and in a more direct manner, by detector enhancements and new crystallographic software. Developments in these two areas must continue and the Upgrade can make a significant impact in extending and catalysing these programmes. As science pushes investigations towards more complex systems, the limits of experimental techniques will be explored. To extend

Courtesy Jim Lake, UCLA, Los Angeles

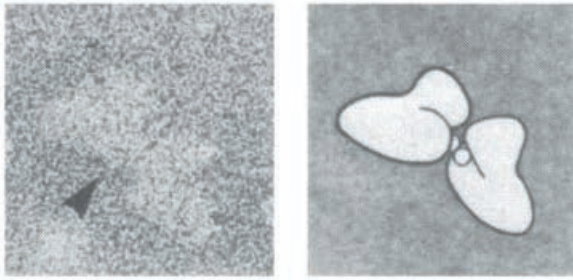
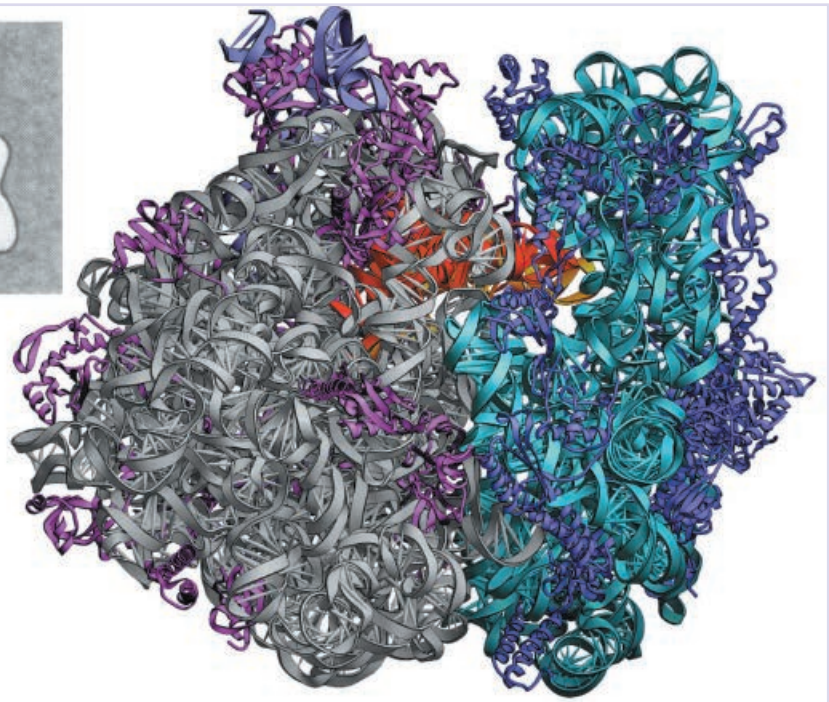

Figure 1.2.3: The progression in the level of understanding of the ribosome structure over a 20-year period. From electron microscopy reconstructions (Oakes *et al.*, 1986), to today's structure of the 70S ribosome.



Courtesy Harry Noller, University of California, Santa Cruz.

these further, highly optimised beamlines suitable for microbeams, long-wavelength experiments and large unit cell (>1000 Å cell edge) data collection will be required, as will facilities allowing extensive, automated screening prior to full X-ray diffraction experiments.

Recent experimental results have revealed the wealth of biological diversity that still needs to be examined. The work of the Global Ocean Survey (GOS) demonstrates the degree of ignorance that exists concerning the range of biological life present within supposedly well examined biospheres. To understand the origins and mechanisms of biological environmental adaptation (*i.e.* the basic process of evolution), the links between amino-acid sequence, protein structure and environment need to be developed. Taking into account the fact that some estimates place the number of distinct microbial species per cubic metre at about 25,000, significant scientific use of the automation tools already under development may be readily imagined. A different view of the biological realm via the study of complex multi-protein systems will also require the use of automation tools to make it possible to optimise the resolution obtainable from the sample available.

Pioneering work on ribosome crystallography has, over a twenty year period, and using a multidisciplinary approach, led to an atomic-level understanding of the ribosomal machinery (Figure 1.2.3). Following on from this, a project that will surely benefit from the use of similar methods is a study aimed at understanding how the eukaryotic spliceosome functions. This is currently being investigated at low resolution (Figure 1.2.4).

It is reasonable to assume that even more complex systems will also become amenable to X-ray diffraction experiments if provided with the necessary combination of dedicated research scientists and well-adapted X-ray beamlines.

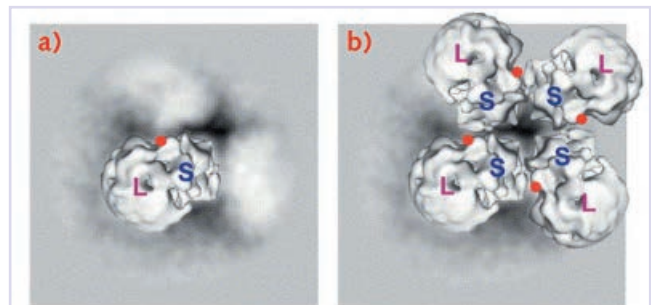

Figure 1.2.4: A refined reconstructed model for the supraspliceosome. The ESRF Upgrade will speed up research on complex and important biological systems such as this by providing a unique state-of-the-art portfolio of beamlines covering the length scales using techniques from SAXS studies to single particle diffraction imaging to specialised crystallography beamlines. (a) The correctly orientated native spliceosome volume placed on the corresponding class average (class 5). (b) An idealised supraspliceosome particle. The main features of the refined model are: (1) The small subunits of the four constituent sub-complexes (blue S) lie at the centre of the particle and are in close contact. (2) The large subunits (magenta L) form the outlying regions of the particle and do not interact directly. (3) There is an approximate 4-fold arrangement of the particle. (4) A hole leading into the cavity (red circle) is positioned opposite the base of the small subunit of the neighbouring sub-complex (Cohen-Krausz *et al.*, 2007).

Reprinted from (Cohen-Krausz *et al.*, 2007). Copyright 2007, with permission from Elsevier.

The ESRF is currently in the unique position of being able to contribute its knowledge towards understanding major biological questions that remain unanswered. The experience gained over a decade of discovering, developing and understanding the tools necessary for structural biology research at third-generation sources has allowed a radical assessment of progress towards creating the ultimate MX facilities. In order to satisfy the demands of structural biology foreseen during the second and third decades of the twenty-first century, it is vital that beamlines are available that allow the collection of both ultra-low and ultra-high resolution data. This should also be the case for facilities allowing the collection of diffraction data at long wavelengths, the optimal collection of variable wavelength data, data from microcrystals and from crystals with very long unit cell axes. The integration of UV and other spectroscopic techniques with X-ray diffraction experiments and the possibility of the screening of many hundreds of samples followed by transfer to the most appropriate beamline is another necessity. This will be possible when the geographical proximity of future MX beamlines at the ESRF is optimised.

Relevant Conceptual Design Reports:

- **HISAXS:** High Throughput Small Angle X-ray Scattering
- **MASSIF:** Massively Automated Sample Screening Integrated Facility
- **MINADIF:** Micro- and Nano-Diffraction
- **MX-BIB:** Biological Imaging Beamline
- **MX-MAD1 and MX-MICROFOCUS:** Macromolecular Crystallography using Multi-Wavelength Anomalous Dispersion and Microfocus
- **MX-MAD2:** Macromolecular Crystallography using Multi-Wavelength Anomalous Dispersion with Microfocus
- **SAXS:** Small Angle X-ray Scattering

Key enabling technologies and infrastructures:

- Reconstitution of the MX beamlines as a village
- Detectors: Large size, high sensitivity
- Laboratory space for interdisciplinarity *e.g.* SAS - MX - CDI techniques
- Automation
- Integrated software solutions

1.2.3. Soft condensed matter: biological applications

The study of functional biological systems is a key element to obtain an integrated view of life in action. As stated in the introduction to this chapter, both high (atomic) resolution and large scale/bulk information is required to fully understand a functional biological system. Experiments that measure these latter properties of biomaterials use the techniques developed in this section, which are complementary to the atomic resolution science presented in [section 1.2.2](#). The imaging of biological matter, adding to the range of techniques to study life, is described in [chapter 1.5](#). The three key areas considered in more detail in this section show that X-ray-based soft condensed matter techniques are becoming increasingly used for biology-oriented experiments. The Upgrade Programme will provide access to smaller sample volumes, larger length scales and shorter timescales for dynamic processes. New experimental tools such as microfluidics or optical tweezers will revolutionise sample manipulation techniques and the study of complex flow phenomena. The establishment of science-driven partnerships, including support facilities and the backing of a modelling/theory group, will be necessary in order to stay ahead in this competitive field.

The study of hierarchical structures

Scanning microSAXS/WAXS can provide composite "diffraction images" of functional biopolymers with local reciprocal space information. For example, the diffraction image of a Norwegian spruce "latewood" cell ([Figure 1.2.5a](#)) using a 3 μm X-ray beam provides local structural information on the cellulose

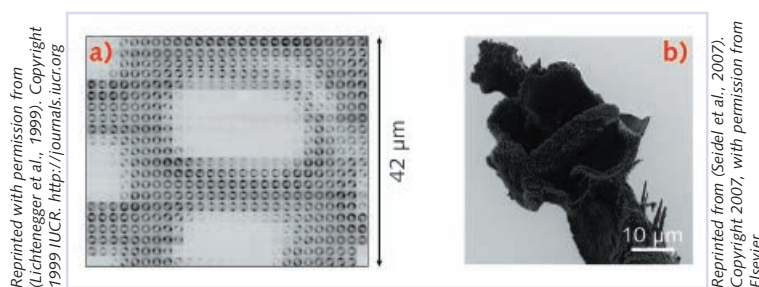

Figure 1.2.5: (a) Composite image of wood cell recorded with a 3 x 3 μm^2 mesh which has laid the basis for future experiments making use of nanosized beams for much greater spatial resolution; (b) cricket flow-sensor sectioned by a micro-laser cutter. Beamlines with nanobeams and access to improved preparation techniques will be developed with the Upgrade to allow samples such as these to be handled and investigated at increased spatial resolution.

Reprinted with permission from Popov D., Burghammer M., Buleon A., Montesanti N., Pultaux J.L., Riekkel C., A-Amylose Single Crystals: Unit Cell Refinement from Synchrotron Radiation Microdiffraction Data, *Macromolecules*, 39, 3704-3706. Copyright 2006 American Chemical Society.

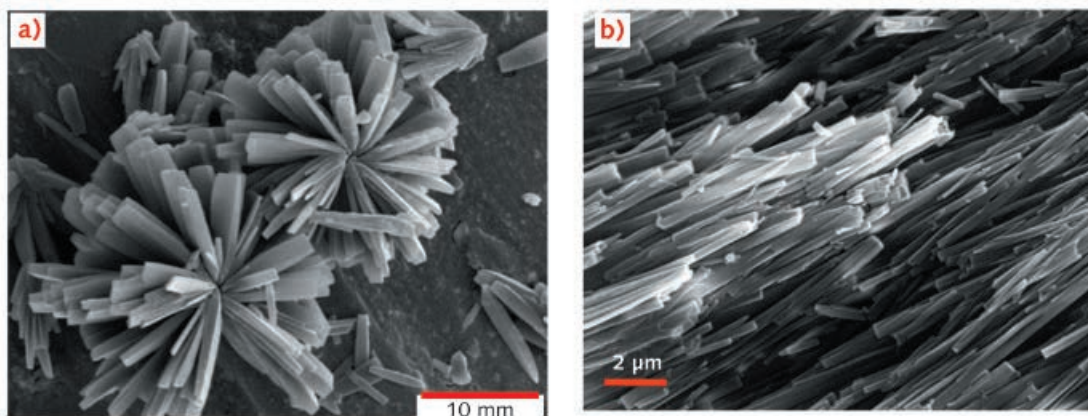

Figure 1.2.6: (a) A-amylose crystals; (b) sericin precursor crystals (sample courtesy of D. Knight, Oxford University). The Upgrade Programme will enable crystals such as these to become amenable to single crystal structure studies using high intensity nanofocused beams.

fibril orientation in the S2 layer (Lichtenegger *et al.*, 1999). Studying the smaller S1-type wood cell wall, however, would require beam sizes down to about 100 nm.

The lack of appropriate data reduction software for the extraction of structural and morphological information from the “diffraction image” has until recently limited the size of composite diffraction images to a few hundred pixels of patterns. The introduction of batch processing software now allows treatment of “diffraction images” with 10^4 or more pixels (Davies, 2006).

Whilst standard sectioning techniques could be used for the study of wood cells, the flow sensing system of a cricket had to be separated from the cricket body by micro-laser sectioning techniques for scanning microSAXS/WAXS (Seidel *et al.*, 2007) (Figure 1.2.5b). This highlights the need to develop new sample preparation techniques. The use of advanced micro-laser sectioning techniques and possibly confocal techniques for the study of embedded biological objects will become more widespread in the future. It is also foreseen that a composite image, as shown in Figure 1.2.5a, will be generated online during data collection and that online analysis tools for extracting structural information will become available. It will also be necessary to integrate optical and spectroscopic techniques into the experimental setup in order to maximise the information obtained from a single experiment. For example, the combination of microRaman with microSAXS/WAXS (Davies *et al.*, 2005) could be used to study amorphous phases encountered during protein aggregation or biomineralisation. The routine availability of complementary techniques is an important asset in catalysing the development of biomimetic systems

such as the extrusion of spider silk (Vollrath and Knight, 2001). The integration of microfluidic technology and rheological modelling into the experiment environment will also be necessary to achieve this.

Beam sizes down to about $1\ \mu\text{m}$, currently being used for studies involving biopolymer crystals of about 10 to $100\ \mu\text{m}^3$ volume (Riekkel *et al.*, 2005), provide opportunities for replacing low-resolution fibre diffraction by high-resolution single crystal studies. This has already been demonstrated for A-amylose (Popov *et al.*, 2006) (Figure 1.2.6a). The challenge lies in decreasing the accessible crystal volume to the 1 to $10\ \mu\text{m}^3$ range for biopolymer crystals and all the way up to crystals of large macromolecular complexes. This is only possible if new approaches with sub-micrometre beams, single-photon-sensitive 2D-detectors, advanced sample environments, and sample handling are developed and techniques such as averaging scattering data from multiple crystals (Riekkel *et al.*, 2005) are introduced. It has been demonstrated (Li *et al.*, 2004, Coulibaly *et al.*, 2007) that crystals of this size are tractable for macromolecular structure determination, although radiation damage will remain an issue and must be addressed. Thus the sericin precursor crystals shown in Figure 1.2.6b may become amenable to structural studies in the future.

At the cellular level, SAXS/WAXS studies on components are usually performed on extracted and purified materials. Performing such studies under physiological conditions on cell substructures (including single cell nuclei) such as the plastid family of organelles which includes such diverse members as amyloplasts and chloroplasts is highly interesting. Indeed, SAXS/WAXS patterns have already been collected from potato starch

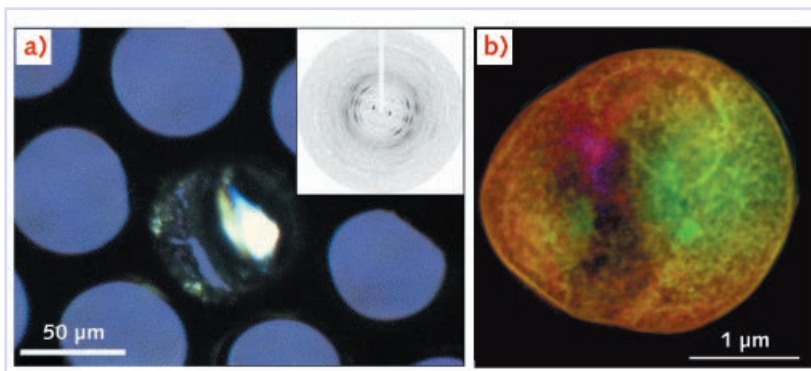
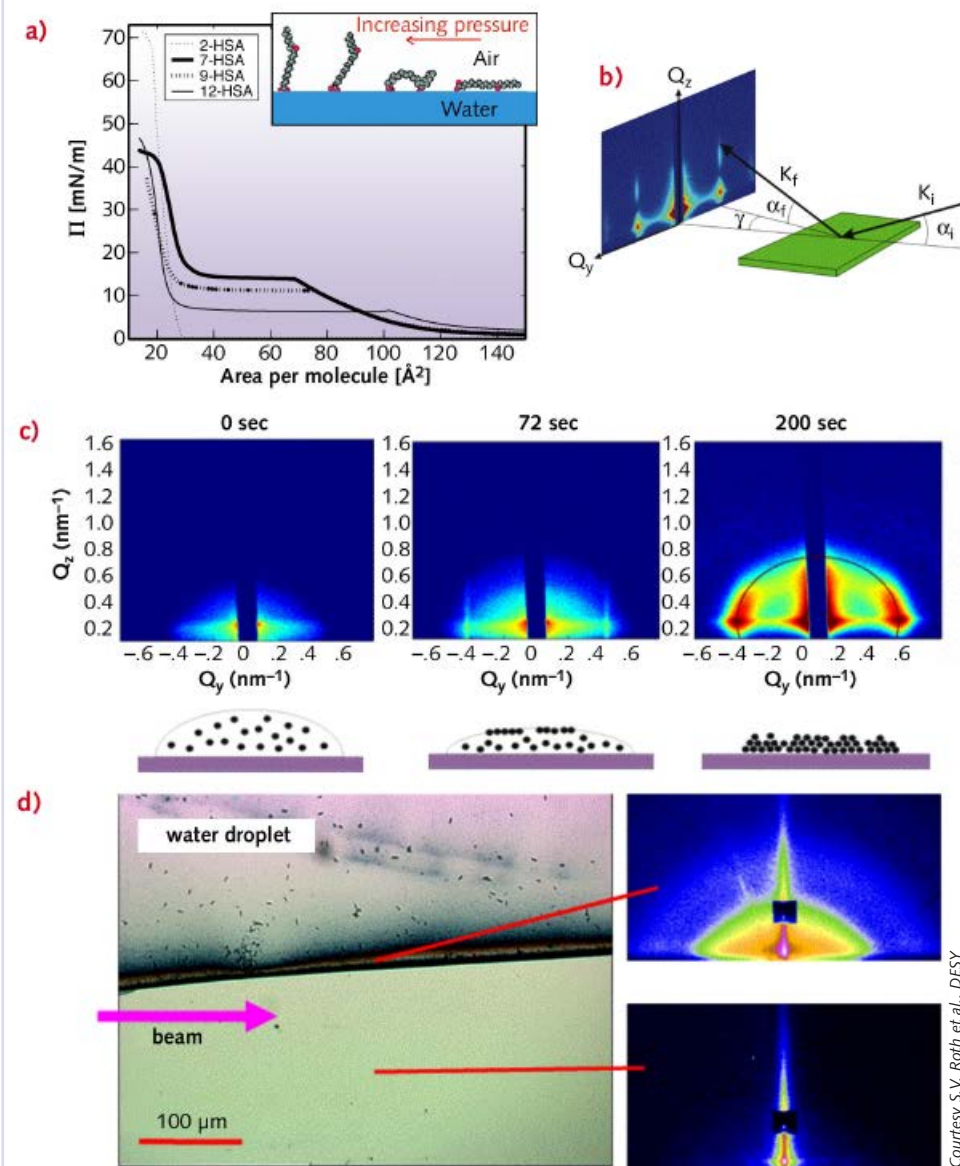

Figure 1.2.7: (a) Single potato starch amyloplast on a copper grid. The inset shows a single scattering pattern from the granule obtained using a $1 \times 1 \mu\text{m}^2$ beam (courtesy: H. Lemke, Copenhagen University). (b) Image of yeast cell at 30 nm resolution obtained by coherent diffraction using 750 eV photons (Shapiro *et al.*, 2005), image courtesy E. Lima (Lima E., 2006). At the ESRF, the Upgrade includes development of the coherent diffraction technique to image fragile single particles at high resolution. For example, the ideas include a beamline dedicated to biological diffraction imaging (CDR: MX-BIB).

Courtesy L. Cristofolini, University of Parma, Italy



Courtesy S.V. Roth *et al.*, DESY

Figure 1.2.8: (a) Langmuir compression isotherms measured using GID for different hydrosteric acids at room temperature (Cristofolini *et al.*, 2005); inset: sketch of the molecular conformation at the air-water interface as a function of the surface pressure; (b) schematic GISAXS geometry; (c) GISAXS pattern evolution during self-assembly upon drying of ~ 5.5 nm Co magnetic nanoparticles dispersed in toluene. A schematic image of the process is shown below (courtesy Y. Chushkin, ESRF-ID10); (d) water droplet on a Si-surface; a Au colloid solution spread on the water droplet is at the origin of the upper GISAXS pattern recorded with a 300 nm beam; the modified lower GISAXS pattern is due to dried gold colloids at the silicon surface (courtesy: S. Roth, DESY-Hamburg; ESRF-ID13). The experimental instruments and environment used to perform these nanoGISAXS experiments will need to evolve and become routine as part of the Upgrade.

amyloplasts (Figure 1.2.7a), which suggest that similar studies for other plastids may be feasible. It is envisaged that nano-SAXS/WAXS techniques could be used to study the chromatin organisation in cell nuclei and its change during mitosis, provided that the radiation damage issues can be managed.

An emerging technique for the imaging of cells and other biological specimens is lensless imaging based on coherent diffraction (Figure 1.2.7b), which has the potential to achieve 1 nm resolution (see also chapter 2.2). To date, a resolution of 30 nm has been obtained for a yeast cell using soft X-rays in pioneering work at ALS (Shapiro *et al.*, 2005) (Figure 1.2.7b). The implementation of this technique at the ESRF can be built on the in-house expertise in hard X-ray coherent scattering. XANES is a complementary technique for cellular level

measurements and XRF for mapping elements such as sulphur or metal ions at the nanometre scale (Daly *et al.*, 2007). The combination of structural, imaging and spectroscopic techniques will provide a new level of understanding of the biochemical processes that are at the origin of functional biopolymers.

Scattering from surfaces

Surface scattering of X-rays from organic layers using grazing-incidence techniques exploiting diffraction (GID), wide-angle and small-angle scattering (GISAXS), as well as X-ray reflectivity (XRR), are already well developed at the ESRF. The Langmuir-Blodgett trough setup on ID10B enabled molecular orientation at liquid interfaces to be studied as a function of surface pressure, temperature and sub-phase composition (Figure 1.2.8a). The crystallography of two-dimensional membrane proteins will be an important subject to be developed (Lenne *et al.*, 2000). The experimental setups will need to evolve for smaller beam sizes so that diffraction and scattering on surfaces can be performed in a non-scanning way. The additional integration of Brewster angle microscopy could provide a complementary *in situ* probe for surface morphologies.

The GISAXS setup is shown schematically in Figure 1.2.8b. A pilot experiment on *in situ* growth and the lateral organisation of metallic colloidal nanoparticles at the liquid/liquid interface in a specifically designed Langmuir trough allowed the kinetics of the particle–particle structure factor variation to be studied (Figure 1.2.8c). NanoGISAXS is of interest for the study of gradient materials or of materials on non-planar surfaces (*e.g.* fibres). This technique can be used for studying gold colloids at the interface of a water droplet with a silicon surface (Figure 1.2.8d). It will be interesting to see whether

single cell membranes become amenable to such studies. Further development of micro/nanoGISAXS for GISD is essential for carrying out studies of chemical reactions at confined liquid/liquid interfaces.

The dynamics of structures and processes

From early on in research employing synchrotron light, muscle scattering has been a driving force for advancements in synchrotron radiation instrumentation. Advances have been so noteworthy that it is now possible to probe angstrom-scale axial motions of myosin heads during the working stroke (Reconditi *et al.*, 2004). Efforts are continually being made to address the issue of control of biochemical conditions using demembrated fibres. This will result in a new type of study relating biochemical activity to the structural and mechanical transitions. Using smaller beams may mean that it becomes possible to extend these *in situ* studies to large regulatory proteins involved in muscle activity such as tropomyosin or even to the single sarcomere level (Iwamoto *et al.*, 2005).

Protein folding and aggregation can be studied by stopped-flow techniques down to the millisecond timescale. Shorter timescales are, in principle, accessible via microfluidics technology (Figure 1.2.9a) combined with microbeam mapping (Riekkel *et al.*, 2004), which has the additional advantage of requiring only small sample quantities and allowing combinatorial approaches. Complementary techniques are inkjet systems using less than 100 pL droplet volumes (Haberkorn *et al.*, 2003) or nanojets (Cojoc *et al.*, 2006). Studying protein folding at the microsecond timescale will require nanoSAXS and custom-made nanofluidic cells to be combined. Fast structural processes can also be initiated by the fusion of filled vesicles via optical traps in a microfluidic environment (Cojoc *et al.*, 2006) (Figure 1.2.9b).

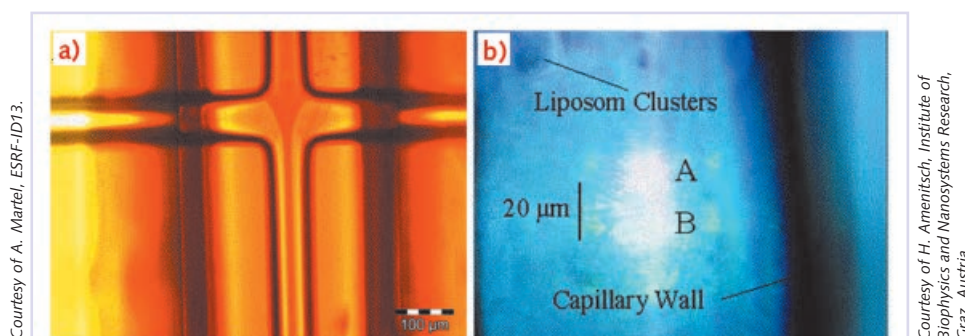

Figure 1.2.9: (a) A hydrodynamic focusing microfluidics cell; (b) two liposome aggregates (A,B) trapped in a glass capillary by optical tweezers. These images typify the type of developments required in the sample environment and the experimental apparatus and sample manipulation/ support required to handle the tiny, fragile samples that will be studied on the upgraded beamlines.

Courtesy of A. Martel, ESRF-ID13.

Courtesy of H. Amenitsch, Institute of Biophysics and Nanosystems Research, Graz, Austria.

The further development and modelling of efficient optical, electrical and magnetic traps for sample manipulation in a confined environment creates a fascinating and critical challenge, that of making it possible to undertake effective experiments using minute and fragile samples.

Relevant Conceptual Design Reports:

- GISD: Grazing incidence scattering and diffraction
- HISAXS: High-throughput SAXS
- INELX: Inelastic X-ray scattering
- MINADIF: Micro- and nano-diffraction
- SAXS: Small-angle X-ray scattering
- SFINX: Scanning fluorescence and imaging at the nanoscale using X-rays
- SMILE: X-ray microscopy
- XPCS-CXS: X-ray photon correlation spectroscopy and coherent X-ray scattering

Key enabling technologies and infrastructures:

- Condensed matter theory
- CCD-based and pixel-detectors
- AFM integrated into beamlines
- Chemical and biochemical laboratories at beamlines
- Advanced imaging, manipulation and section techniques laboratory at beamlines
- Office and laboratory space for soft condensed matter partnerships

1.2.4. Soft and fragile matter: microstructure, dynamics and out-of-equilibrium phenomena

Scattering techniques (X-rays, light and neutrons) have significantly contributed to our understanding of equilibrium microstructure and dynamics, and out-of-equilibrium processes in soft matter. However, in recent years, real-space imaging and manipulation methods have also gained tremendous importance. These approaches have certain advantages in revealing qualitative features. Nonetheless, scattering techniques remain essential for seeking deeper structural, dynamic or kinetic information. The complementary nature of scattering and imaging techniques is crucial in unravelling the full richness of soft matter. An upgrade of the ESRF portfolio of soft-matter beamlines is essential to extend the current limits of scattering techniques to unexplored regions of the mesoscopic scale. These instrument developments need to be complemented by both the ability to synthesise model systems and the availability of state-of-the-art sample environments

and modelling in terms of advanced computational methods. In this respect, the development of a Soft Matter Partnership together with ILL will be a major step forwards in the exploitation of scattering techniques on the Grenoble international site. For industrial applications of scattering techniques, advances in the modelling of polydisperse and multi-component systems will also be an important development.

Equilibrium microstructure and dynamics

The investigation of phase behaviour, equilibrium microstructure and dynamics remains an essential part of soft-matter research. The relationship between mesoscopic structure/dynamics and macroscopic physical properties is of both fundamental and practical interest. For example, self-assembly is one of the key features of many soft-matter systems such as surfactants, block copolymers, biomaterials, etc. (Robinson, 2003). Exploring these self-assembled hierarchical structures and their response to external fields constituted a substantial part of soft-matter research in the past. The focus has been shifting to understanding the kinetic pathways of self-assembly leading to desired structure and function, the role of competing interactions and the complexities that lie beyond hierarchical structures.

The use of different scattering techniques provides complementary information. For example, high-resolution small-angle and ultra-small-angle X-ray

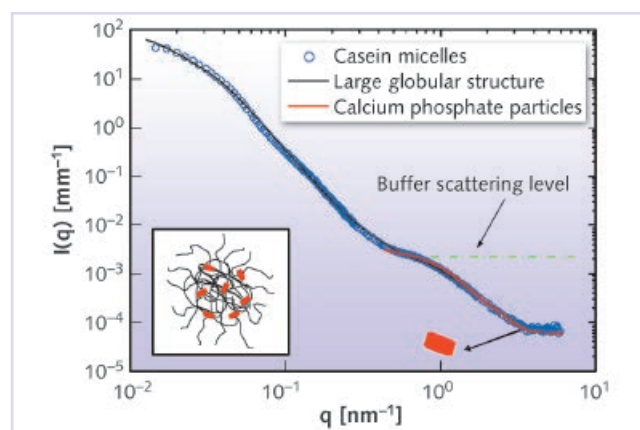

Figure 1.2.10: Scattering from a dilute suspension (<1%) of casein micelles over a wide scattering vector range under normal physico-chemical conditions. The ability to detect low scattering signals of a few percent above the buffer level is critical in deriving the shape and size of the calcium phosphate particles reticulated in the protein matrix – detector improvements are essential if this is to be improved further. The inset shows a sketch of the overall globular structure referring to the fitted model.

scattering (SAXS and USAXS, respectively) are widely used to elucidate the bulk microstructure whilst grazing incidence SAXS/diffraction (GISAXS/GISD) provide the corresponding information at interfaces. The equilibrium dynamics at the pertinent length scales can be studied using X-ray photon correlation spectroscopy (XPCS). This is currently limited by the signal-to-noise ratio for fast dynamics at large momentum transfers due to the limited coherent photon flux available. The proposed upgrade and the linked advent of fast detectors will extend the current limits to the sub-microsecond range. Implementation of the near-field X-ray scattering technique (NFXS) would, in principle, extend the limits of USAXS and XPCS to extremely small scattering vectors (q) $\sim 10^{-4}$ nm $^{-1}$. The exploitation of anomalous effects in small-angle scattering (ASAXS), GISD and reflectivity provides unique information about charge distribution in bulk and at interfaces (*e.g.* oil–water interfaces, polyelectrolytes, etc.).

The development of high performance detectors with single photon sensitivity, high spatial and time resolution and dynamic range is of central importance for the advancement of different scattering techniques. In static structural studies, the improvement in the detection limit below 0.1% of the solvent scattering would enable high-resolution information not readily accessible to any other technique to be extracted. **Figure 1.2.10** depicts the scattering from a dilute non-interacting suspension of casein micelles – the main protein component of milk. The high intensity in the low q range and low scattering signal in the high q region provide information about the globular micelles and the encapsulated calcium phosphate particles, respectively. In this case, the ability to detect low scattering signals of a few percent above the buffer level is critical in deriving the shape and size of the calcium phosphate particles. A similar detection capability is also crucial in the *in situ* investigations of aerosol systems (volume fraction around 10^{-8} to 10^{-6}), grazing incidence diffuse scattering experiments to distinguish interface scattering from the bulk and anomalous scattering studies with solutions of soft matter and biological macromolecules.

That faster detectors can extend the accessible time-range of XPCS to the sub-microsecond region has already been demonstrated in the vicinity of Bragg peaks and specular reflections on free-standing smectic liquid crystalline membranes (Sikharulidze *et al.*, 2002). **Figure 1.2.11** shows the typical intensity autocorrelation function for specular and off-specular scattering indicating a transition from an oscillatory damping to simple exponential behaviour. With the proposed upgrade, such studies could be carried out with diffuse scattering on a much wider range of systems. Finally, one could envision using

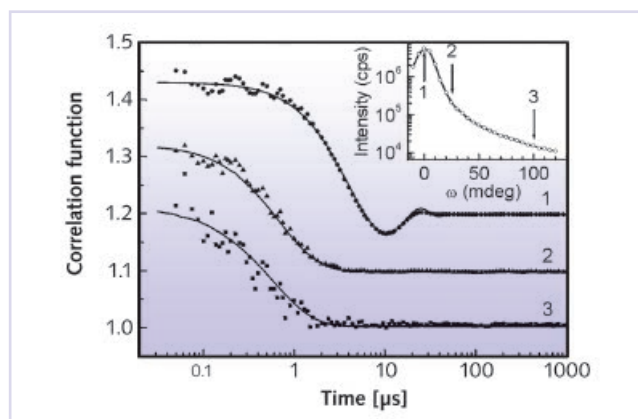

Figure 1.2.11: Intensity autocorrelation functions of 2.83 μm thick smectic liquid crystalline membrane at the specular position (1) and off-specular positions (2, 3) illustrating a transition from damped oscillatory to simple exponential decay (Sikharulidze *et al.*, 2002). Inset shows the Bragg peak position. With an increase in coherent flux and faster detectors, such studies could be carried out with diffuse scattering on a much wider range of systems.

Reprinted figure with permission from I. Sikharulidze, I.P. Dolbnya, A. Fera, A. Madsen, B.I. Ostrovskii, W.H. de Jeu, *Smectic Membranes in Motion: Approaching the Fast Limits of X-ray Photon Correlation Spectroscopy*, *Phys. Rev. Lett.* 88, 115503 (2002). Copyright 2002 by the American Physical Society. <http://link.aps.org/abstract/PRL/v88/e115503>

polarisation-dependent XPCS to investigate the rotational dynamics of rod-like objects, as well as magnetic effects (coarsening and dynamics of magnetic domains, magneto-hydrodynamics, etc.). Such studies are today at the limit of feasibility because of the significant loss in flux associated with defining the polarisation state of the X-rays and/or performing the polarisation analysis of the scattered intensity.

Complimentary to static and dynamic X-ray scattering discussed above, inelastic X-ray scattering (IXS) techniques probe the collective dynamics in liquids and disordered molecular systems at mesoscopic length scales. In this region, the thermodynamic and transport coefficients of atomic systems are dependent on length- and timescales (Boon and Yip, 1991). Within the framework of the Upgrade, the currently inaccessible crossover region between the macroscopic and the mesoscopic ranges will become accessible to IXS and will provide information over the unexplored space and time domains (up to 600 \AA and 300 ps). A more in-depth description of this technique can be found in **chapter 1.4**. Nuclear resonance scattering (NRS) is another technique that bridges the mesoscopic and macroscopic ranges, thanks to the intrinsic energy resolution provided by nuclear transitions (nano-electronvolt range). In particular, the Rayleigh scattering of Mössbauer radiation allows nano-microsecond dynamic processes to be studied on a spatial scale from 0.1 to 100 nm. A mature spectroscopic technique will then be able to be produced in collaboration with the detector upgrade (detailed in **chapter 2.5**).

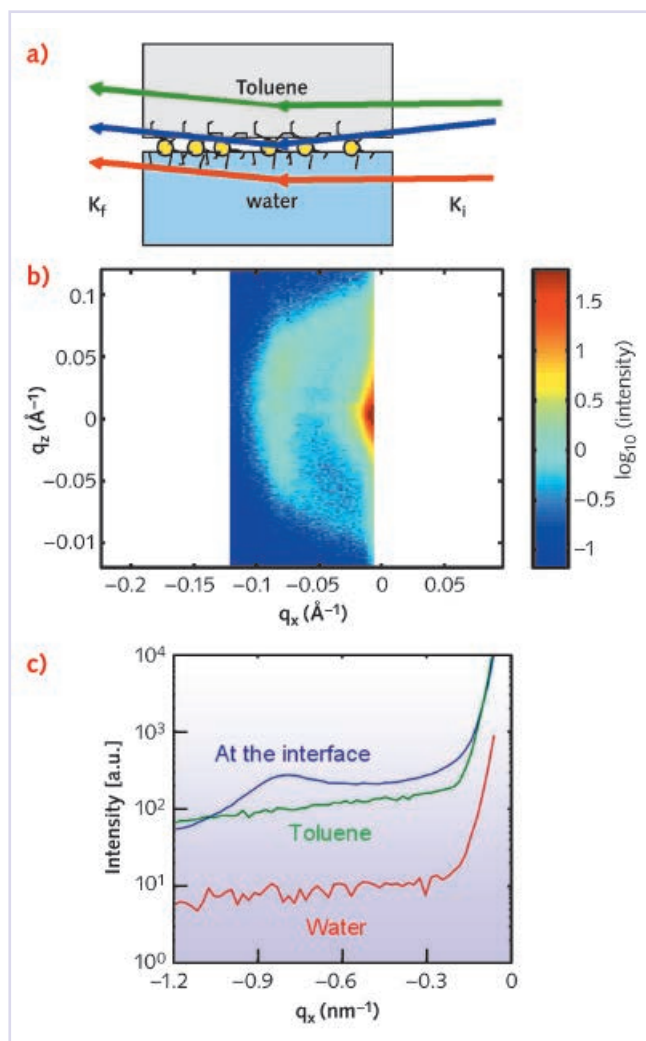

Figure 1.2.12: Ordering of gold nanoparticles (5 nm) at the liquid-liquid interface of toluene and water (a). GISAXS pattern (b) and the corresponding cuts along the plane (c) revealing the preferential ordering of particles at the interface. The combination of improved detectors, dedicated experimental infrastructures, high-energy X-rays (20 to 30 keV) and micrometre beam sizes are important aspects for this study and will be available following the Upgrade.

Confined geometries and buried interfaces

The nanoscale investigation of buried liquid-liquid and liquid-solid interfaces in soft matter is a challenging problem. The combination of GISAXS using high-energy X-rays (20 to 30 keV) with a micrometre beam size is a sensitive tool for these investigations and the Upgrade will strengthen the ESRF capability in this domain. Figure 1.2.12 presents a simple demonstration of this in a study of the ordering of nanoparticles at a liquid-liquid interface. Similar studies can be extended to more realistic systems. For instance, recent experimental advances have made it possible to address certain long-standing issues in this field, e.g. the depletion layer at the interface between water and a hydrophobic surface (Mezger *et al.*, 2006) which is

important in many fields of physics and biology. The dynamics of a liquid interface can be probed by XPCS but, at present, such studies are only feasible for very slow dynamics (glassy systems) (Streit *et al.*, 2007), or at sub-micrometre length scales at solid-liquid interfaces (Madsen *et al.*, 2005). It is expected that the Upgrade will allow other systems, such as liquid crystals, liquid metals, and nanoparticles, to be investigated on much smaller length scales than that accessible today.

Similar studies can be extended to solid-liquid interfaces in confined geometries such as microfluidic devices. Understanding the effects of roughness and surface morphology on the flow-fields at nanometre scales have not been performed so far. Such studies are essential prior to exploiting these flow devices for static and dynamic X-ray scattering experiments. XPCS combined with microfluidics is an extremely promising method to investigate the effect of confinement on the dynamics of soft matter (colloids, polymers, proteins, etc.). These studies necessitate the Upgrade in particular to obtain the required coherent flux in a sub-micrometre beam. Development of micro- and nanofocusing optics is essential for pushing the limits of GISAXS and XPCS in confined geometry and at interfaces.

Probing the interfacial film organisation at liquid-liquid interfaces using GISD provides access to the elastic properties of Langmuir and Gibbs layers. Figure 1.2.13 illustrates that the lowering of the

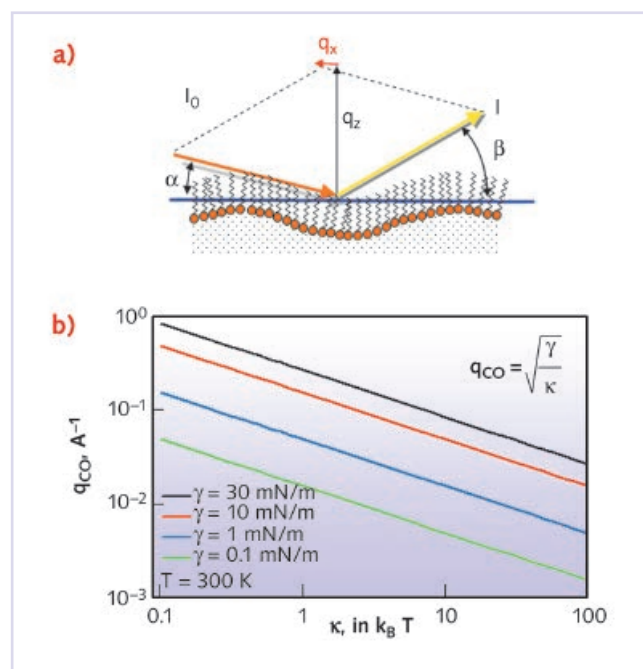

Figure 1.2.13: Illustration of membrane undulations at a liquid-liquid interface (a). Lowering of the surface energy (γ) pushes the undulation modes to lower q values (b) allowing the small bending rigidity (κ) to be determined. The liquid-liquid interface provides the ability to tune the surface energy (γ).

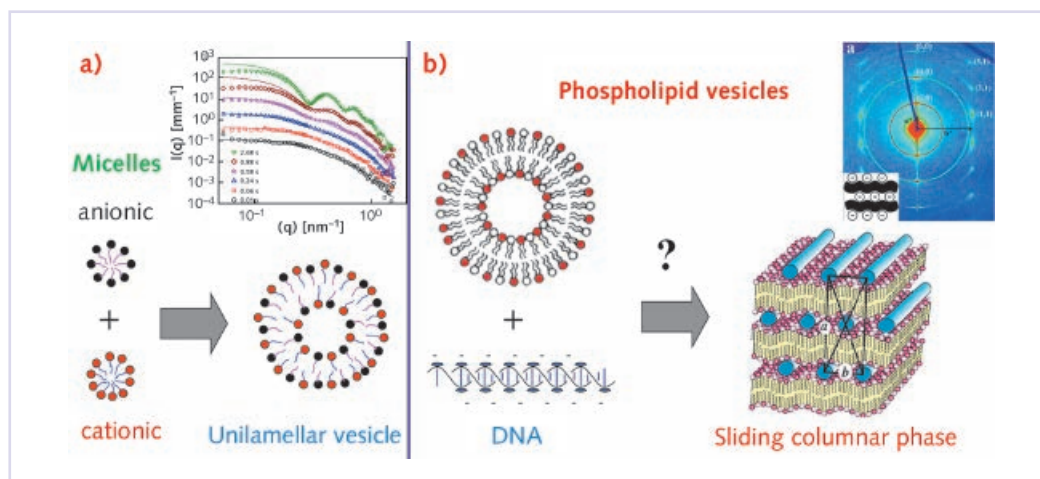

Figure 1.2.14: Schematic representation of (a) transformation of micelles to unilamellar vesicles and (b) complexation of phospholipid vesicles and DNA to form quasi-long-range ordered sliding columnar phases. Upper right corner presents the corresponding SAXS pattern from these systems. The kinetic pathways of self-assembly for the latter have not been explored so far but could be feasible following the improvement in infrastructure and detectors.

surface energy is an ideal means to probe small bending rigidity of membranes. Thin film dynamics have been widely explored with XPCS and, for instance, it has been observed that liquid thin films in a partial wetting condition are static, *i.e.* the capillary waves are absent on length scales much below the van der Waals cut-off (Gutt *et al.*, 2007). At present, such XPCS experiments are limited to millisecond range and length scales greater than 100 nm due to the limitations in coherent flux and detectors. Investigations on smaller length scales, enabled with the Upgrade, could be carried out, for example, to find the point where thin liquid film starts behaving as a liquid, or to better understand the influence of the interactions with the substrate.

Out-of-equilibrium processes

The equilibrium states discussed in previous sections can be driven out-of-equilibrium by a jump in any thermodynamic variable, application of an external deformation, the effects of hydrodynamic flow or competing attractive and repulsive interactions. This topic involves a myriad of issues such as the kinetic pathways of the ordering process, for example, self-assembly of amphiphilic molecules, the relationship between microstructure/dynamics, and bulk rheology, universal dynamics of kinetically-arrested states, etc. Scattering techniques are ideally suited for addressing these issues.

(a) Kinetics of self-assembly

The self-assembly of amphiphilic molecules leads to a variety of fascinating structures. Some of these systems mimic more complex biological entities, for

example, a phospholipid unilamellar vesicle is a model for the cell membrane. Moreover, such self-assembled systems have important practical applications such as vectors for drug delivery, nanotemplates and reactors. At present, relatively simple micellar transformations (*e.g.* spontaneous self-assembly of unilamellar vesicles) as schematically depicted in Figure 1.2.14a can be studied reasonably well (Weiss *et al.*, 2005). If the instrumentation and infrastructure were improved, the kinetic pathways of more intricate systems such as complexes of phospholipid membranes and DNA (Rädler *et al.*, 1997; F. Artzner, unpublished) shown in Figure 1.2.14b would become feasible in the future. High-resolution Bragg peak analysis of well oriented samples using SAXS and GISAXS is an important technique to elucidate the structure and elastic properties of these systems. One of the key questions to be answered is how kinetic competition in self-assembly results in unique structural features. This has important implications not only in understanding how Nature has achieved a desired function via optimised self-assembly processes over millions of years of evolution, but it also has direct applications in nano- and biotechnologies. The large variety of systems to be studied include the complexes of amphiphilic molecules or block copolymers with biopolymers in bulk and at interfaces. Real-time SAXS, USAXS and GISAXS experiments could provide unique information, inaccessible up to now. Undertaking complementary dynamic scattering experiments (with XPCS) on such transient systems is more challenging but could become feasible when the corresponding kinetics are slower.

Many natural and industrial processes occur under open non-equilibrium conditions. An example is the pyrolytic production of nanoparticles (Beaucage *et*

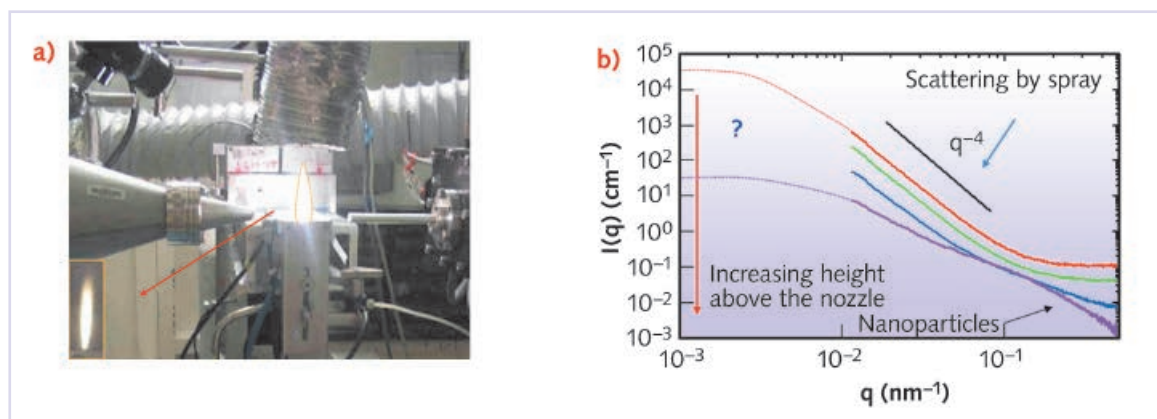

Figure 1.2.15: Flame spray pyrolysis (a) is a promising technology for industrial production of a variety of ceramic nanoparticles. A key question is how the precursor spray droplets fragment at sonic speeds, evaporate and then initiate the nucleation of nanoparticles. This is a multi-scale transient process occurring in the sub-millisecond range (height above the nozzle is a kinetic time). At present, the nucleation and growth of nanoparticles can be studied but access to droplet dynamics is limited (see the power law scattering in (b)).

A long pinhole USAXS instrument, as planned in the Upgrade (see CDR **SAXS**), would allow simultaneous investigation of spray droplet fragmentation (dashed scattering curves in (b)), and nucleation and growth of nanoparticles.

al., 2004). **Figure 1.2.15** pictorially depicts the experimental setup for flame spray pyrolysis. A key question is how the precursor spray droplets fragment at sonic speeds and evaporate at high temperature (2500 K) to initiate nucleation and growth of nanoparticles. A detailed understanding of these processes is important for the optimisation of industrial production and also at the same time interesting from a fundamental point of view (*e.g.* the dynamics of fragmentation of spray droplets). The main challenge is that underlying processes involve rapid kinetics (sub-millisecond range), multiple

length scales (*e.g.* micrometre sized droplets or nanometric particles), and low volume fractions ($\sim 10^{-6}$). At present, the nucleation and growth of the nanoparticles can be probed by SAXS but there is little information about the injection, fragmentation, and evaporation of the droplets (the region indicated by a question mark in **Figure 1.2.15b**). Development of a long pinhole USAXS instrument would allow *in situ* studies of this type of transient process. Note that light scattering is not suitable for this study due to strong optical emission from the flame.

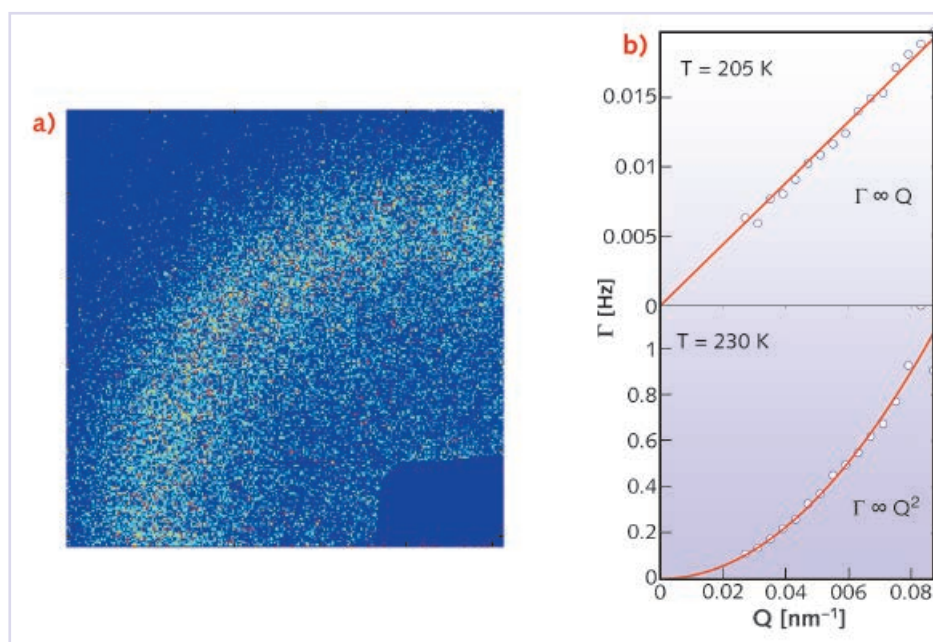

Figure 1.2.16: (a) Speckle pattern showing the coherent SAXS from a suspension of colloidal spheres in a near-vitreous solvent. (b) Dispersion relations extracted from intensity fluctuations of the speckle pattern at two temperatures while approaching the glass transition of the solvent. The linear Γ vs q behaviour at low T is indicative of the onset of collective motion. The two-dimensional speckle pattern demonstrates the importance of the detector in terms of low noise and high spatial resolution for this type of study (see chapter 2.5 for detail on the Upgrade detector programmes).

(b) Dynamics of arrested states

In recent years, kinetically-arrested states in short-range attractive systems (colloids, clays, micelles, proteins, etc.) have been the subject of considerable theoretical and experimental analysis (Sciortino and Tartaglia, 2005). Predictions of mode-coupling theory and computer simulation have allowed the unification of dynamic arrest scenarios in an apparently diverse class of systems and revealed striking similarities with the glass transition. Whilst USAXS provides quantitative information about subtle changes in interaction potential (Narayanan *et al.*, 2006), XPCS is suited to the exploration of slow dynamics (*e.g.* ageing) in these soft glassy systems. The ensemble-averaged intermediate scattering function obtained using multispeckle XPCS can be directly compared with the theoretical predictions. Recent studies of these soft glasses in the bulk and fragile molecular glasses at the air/liquid interface (Streit *et al.*, 2007) revealed striking similarities as demonstrated by their hyperdiffusive and strongly intermittent dynamics. **Figure 1.2.16** illustrates the transition from diffusive to hyperdiffusive behaviour of colloid dynamics in the vicinity of the glass transition temperature of the solvent (Caronna *et al.*, 2006). Further work is needed to establish the connection between the so-called dynamic heterogeneities and collective dynamic behaviour in this case. At the moment, XPCS can only access the slower α -relaxation which freezes out in the glassy state but the Upgrade, together with faster 2D detectors, could provide access to short-time relaxations present in these systems. This is essential to compare the glass transition of fragile molecular glasses to kinetic glass transitions frequently encountered in soft matter (*e.g.* gelation and the colloidal glass transition).

A complete statistical mechanical description of slowly relaxing glassy states is a major theoretical challenge (Kurchan, 2005). Nevertheless, recent advances in computational resources and techniques have made length- and timescales relevant for X-ray scattering and spectroscopy experiments more accessible to computer simulations. These computational techniques include Newtonian and Brownian molecular dynamics, Monte Carlo, Lattice Boltzmann equation and structure optimisation. The input from theory and simulation is essential for the proper interpretation of results from advanced scattering experiments.

Relevant Conceptual Design Reports:

- **GISD:** Grazing Incidence Scattering and Diffraction
- **HISAXS:** High Throughput Small Angle X-ray Scattering
- **INELX:** Inelastic X-ray Scattering
- **MINADIF:** Micro- and Nano-Diffraction
- **NR-NSM:** Nuclear Resonance - Nanoscale Materials
- **SAXS:** Small Angle X-ray Scattering
- **SMILE:** Spectro-Microscopy and Imaging at Low Energies
- **XPCS-CXS:** X-ray Photon Correlation Spectroscopy and Coherent X-ray Scattering

Key enabling technologies and infrastructures:

- Availability of high-spatial resolution and large-dynamic range 2D detectors.
- Development of high-time and high-spatial resolution detectors.
- High performance (stability and coherence preservation) microfocusing optics.
- Advanced data analysis methods based on analytical theories and computer simulations.
- Precision sample environments for surface and bulk studies.

References

- Abad-Zapatero C. (2007), Notes of a protein crystallographer: quo vadis structural biology?, *Acta Crystallogr.*, **D63**, 660-664.
- Alberts B. (1998), The cell as a collection of protein machines: preparing the next generation of molecular biologists, *Cell*, **92**, 291-294.
- Amunts A., Drory O., and Nelson N. (2007), The structure of a plant photosystem I supercomplex at 3.4 Å resolution, *Nature* **447**, 58-63.
- Beaucage G., Kammler H.K., Strobel R., Mueller R., Pratsinis S.E., and Narayanan T. (2004), Probing the dynamics of nanoparticle growth in a flame using synchrotron radiation, *Nat. Mater.*, **3**, 370.
- Beteva A., Cipriani F., Cusack S., Delageniere S., Gabadinho J., Gordon E.J., Guijarro M., Hall D.R., Larsen S., Launer L., Lavault C.B., Leonard G.A., Mairs T., McCarthy A., McCarthy J., Meyer J., Mitchell E., Monaco S., Nurizzo D., Pernot P., Pieritz R., Ravelli R.G., Rey V., Shepard W., Spruce D., Stuart D.I., Svensson O., Theveneau P., Thibault X., Turkenburg J., Walsh M., and McSweeney S.M. (2006), High-throughput sample handling and data collection at synchrotrons: embedding the ESRF into the high-throughput gene-to-structure pipeline, *Acta Crystallogr.*, **D62**, 1162-1169.
- Boon J.P., and Yip S. (1991), *Molecular Hydrodynamics*, (McGraw-Hill, New York, 1980).
- Caronna C., Chushkin Y., Fluerasu A., Ponchut C., and Madsen A. (2006), Multi-speckle XPCS using a pixelated 2D detector ESRF Spotlight on Science: <http://www.esrf.eu/news/spotlight/spotlight39/>.

- Cates M.E. and Evans M.R., Editors (2000), *Soft and Fragile Matter: Nonequilibrium Dynamics, Metastability and Flow*, Bristol: IOP Publishing.
- Cipriani F., Felisaz F., Launer L., Aksoy J.S., Caserotto H., Cusack S., Dallery M., di-Chiaro F., Guijarro M., Huet J., Larsen S., Lentini M., McCarthy J., McSweeney S., Ravelli R., Renier M., Taffut C., Thompson A., Leonard G.A., and Walsh M.A. (2006), Automation of sample mounting for macromolecular crystallography, *Acta Crystallogr.*, **D62**, 1251-1259.
- Cohen-Krausz S., Sperling R., and Sperling J. (2007), Using Electron Microscopy to Uncover the Structural Arrangement within the Intact Supraspliceosome, *J. Mol. Biol.*, **368**, 319-327.
- Cojoc D., Ferrari E, Garbin V., Di Fabrizio E., Amenitsch H., Rappolt M., Sartori B., Riekkel C., and Burghammer, M. (2006), Combined laser trapping and small-angle x-ray scattering experiment for the study of liposome colloidal microparticles, *Proceedings SPIE*, **6326**, M-1-63261M-6.
- Coulibaly F., Chiu E., Ikeda K., Gutmann S., Haebel P.W., Schulze-Briese C., Mori H., and Metcalf P. (2007), The molecular organization of cyovirus polyhedra, *Nature*, **446**, 97-101.
- Cristofolini L., Fontana M.P., Boga C., and Konovalov O. (2005), Microscopic structure of crystalline Langmuir monolayers of hydroxystearic acids by X ray reflectivity and GID: OH group position and dimensionality effect, *Langmuir*, **21**, 11213-11219.
- Daly M.J., Gaidamakova E.K., Matrosova V.Y., Vasilenko A., Zhai M., Leapman R.D., Lai B., Ravel B., Li S.M., Kemner K.M., and Fredrickson J.K. (2007), Protein Oxidation Implicated as the Primary Determinant of Bacterial Radioresistance, *PLoS Biol.*, **5**, e92.
- Davies R. (2006), A new batch-processing data-reduction application for X-ray diffraction data, *J. Appl. Crystallogr.*, **39**, 267-272.
- Davies R., Burghammer M., and Riekkel C. (2005), Simultaneous microRaman and synchrotron radiation microdiffraction: Tools for materials characterization, *Appl. Phys. Lett.*, **87**, 264105-264108.
- Gutt C., Sprung M., Fendt R., Madsen A., Sinha S.K., and Tolan M. (2007), Partially wetting thin liquid films: Structure and dynamics studied with coherent X-rays, *Phys. Rev. Lett.*, **99**, 096104.
- Haberkorn H., Franke D., Frechen T., Goesele W., and Rieger J. (2003), Early stages of particle formation in precipitation reactions-quinacridone and boehmite as generic examples, *J. Colloid. Interf. Sci.*, **259**, 112-126.
- Iwamoto H., Inoue K., Fujisawa T., and Yagi N. (2005), X-ray microdiffraction and conventional diffraction from frozen-hydrated biological specimens, *J. Synchrotron Radiat.*, **12**, 479-483.
- Kurchan J. (2005), In and out of equilibrium, *Nature*, **433**, 222.
- Lenne P.F., Berge B., Renault A., Zakri C., Venien-Bryan C., Courty S., Balavoine F., Bergsma-Schutter W., Brisson A., Grübel G., Boudet N., Konovalov O.V., and Legrand J.F. (2000), Synchrotron Radiation Diffraction from Two-Dimensional Protein Crystals at the Air/Water Interface, *Biophys. J.*, **79**, 496-500.
- Li J., Edwards P., Burghammer M., Villa C., and Schertler G.F.X. (2004), Structure of bovine rhodopsin in a trigonal crystal form, *J. Mol. Biol.*, **343** (5), 1409-1438.
- Lichtenegger H., Müller M., Paris O., Riekkel C., and Fratzl P. (1999), Imaging of the helical arrangement of cellulose fibrils in wood by synchrotron X-ray microdiffraction, *J. Appl. Crystallogr.*, **32**, 1127-1133.
- Lima E. (2006). The Advancement of Biological Imaging Through X-ray Diffraction Microscopy, Thesis, http://xray1.physics.sunysb.edu/research/pdf_papers/dissertations/lima_phd_2006.pdf.
- Madsen A., Seydel T., Tolan M., and Grübel, G. (2005), Grazing-incidence scattering of coherent X-rays from a liquid surface, *J. Synchrotron Radiat.*, **12**, 786.
- Márquez J.A., Galfré E., Dupeux F., Flot D., Moran O., and Dimasi N. (2007), The crystal structure of the extracellular domain of the inhibitor receptor expressed on myeloid cells IREM-1, *J. Mol. Biol.*, **367**, 310-318.
- Mezger M., Reichert H., Schöder S., Okasinski J., Schröder H., Dosch H., Palms D., Ralston J., and Honkimäki V. (2006), High-resolution *in situ* x-ray study of the hydrophobic gap at the water-octadecyl-trichlorosilane interface, *Proc. Natl. Acad. Sci. USA*, **103**, 18401-18404.
- Narayanan T., Sztucki M., Belina G., and Pignon F. (2006), Microstructure and Rheology near an Attractive Colloidal Glass Transition, *Phys. Rev. Lett.*, **96**, 258301.
- Norvell J.C. and Machalek A.Z. (2000), Structural genomics programs at the US National Institute of General Medical Sciences, *Nat. Struct. Biol.*, **7** Suppl., 931.
- Oakes M.I., Clark M.W., Henderson E., and Lake J.A. (1986), DNA Hybridization Electron Microscopy: Ribosomal RNA Nucleotides 1392-1407 are Exposed in the Cleft of the Small Subunit, *Proc. Natl. Acad. Sci. USA*, **83**, 275-279.
- Popov D., Burghammer M., Buleon A., Montesanti N., Putaux J.L., and Riekkel C. (2006), A-Amylose Single Crystals: Unit Cell Refinement from Synchrotron Radiation Microdiffraction Data, *Macromolecules*, **39**, 3704-3706.
- Rädler J.O., Koltover I., Salditt T., and Safinya C.R. (1997), Structure of DNA-Cationic Liposome Complexes: DNA Intercalation in Multilamellar Membranes in Distinct Interhelical Packing Regimes, *Science*, **275**, 810-814.
- Reconditi M., Linari M., Lucii L., Stewart A., Sun Y.B., Boesecke P., Narayanan T., Fischetti R.F., Irving T., Piazzesi G., Irving M., and Lombardi V. (2004), The myosin motor in muscle generates a smaller and slower working stroke at higher load, *Nature*, **428**, 578-581.
- Riekkel C., Burghammer M., Flot D., and Rössle M. (2004), Combined microdrop generation and microdiffraction for biopolymer hydration experiments, *Fibre Diffr. Rev.*, **12**, 36-40.
- Riekkel C., Burghammer M., and Schertler G. (2005), Protein crystallography microdiffraction, *Curr. Opin. Struct. Biol.*, **15**(5), 556-562.
- Robinson B.H., Editor (2003), *Self-Assembly*, Amsterdam: IOS Press.

- Sciortino F. and Tartaglia P. (2005), Glassy colloidal systems, *Adv. Phys.*, **54**, 471.
- Seidel R., Gourrier A., Burghammer M., Riekel C., Jeronimidis G., and Paris O. (2007), Mapping fibre orientation in complex-shaped biological systems with micrometre resolution by scanning X-ray microdiffraction, *Micron*, *in press*, (doi:10.1016/j.micron.2007.02.004).
- Shapiro D., Thibault P., Beetz T., Elser V., Howells M., Jacobsen C., Kirz J., Lima E., Miao H., Neiman A.M., and Sayre D. (2005), Biological imaging by soft x-ray diffraction microscopy, *Proc. Natl. Acad. Sci. USA*, **102**, 15343-15346.
- Sikharulidze I., Dolbnya I.P., Fera A., Madsen A., Ostrovskii, B.I., and de Jeu, W.H. (2002), Smectic Membranes in Motion: Approaching the Fast Limits of X-Ray Photon Correlation Spectroscopy, *Phys. Rev. Lett.*, **88**, 115503.
- Streit S., Gutt C., Chamard V., Robert A., Sprung M., Sternemann H., and Tolan M. (2007), Two-Dimensional Dynamics of Metal Nanoparticles on the Surface of Thin Polymer Films Studied with Coherent X Rays, *Phys. Rev. Lett.*, **98**, 047801.
- Vollrath F. and Knight D.P. (2001), Liquid crystalline spinning of spider silk, *Nature*, **410**, 541-548.
- Weiss T.M., Narayanan T., Gradzielski M., Panine P., Finet S., and Helsby W. (2005), Dynamics of the Self-Assembly of Unilamellar Vesicles, *Phys. Rev. Lett.*, **94**, 038303.

1.3. Structural properties and chemistry of materials

Science context

Understanding a material's structural properties and chemistry is central to many areas of academic and industrial importance including catalysis, the design, synthesis and characterisation of novel materials, Earth and planetary sciences, and fundamental physics. The availability of high brilliance X-ray beams has led to significant developments in these areas and scientists from many fields of research depend on having regular access to dedicated instrumentation exploiting synchrotron radiation.

Structural knowledge is crucial in modern chemistry for understanding and controlling catalytic processes, polymorphism in the formulation of pharmaceutical products, energy storage and transport, and the interaction of molecules with surfaces, etc. Techniques such as single-crystal and powder X-ray diffraction and EXAFS are powerful probes. Structural changes and dynamics in materials on the timescale of molecular processes can be tracked using "pump-and-probe" X-ray experiments with a resolution in the microsecond to picosecond range.

Studies on matter under extreme conditions lead to an understanding of the chemistry, fundamental physics and mechanical properties of matter. The key to many of these studies lies in the combination of high pressure and high temperatures to mimic the conditions used in synthesis and those of planetary interiors, for example, and the use of high brilliance X-ray beams to analyse the tiny quantities of matter available.

Material properties depend strongly on structural features over a broad length scale from the atomic to millimetre. However, studies at the intermediate sub-micrometre scale are particularly important in metals, ceramics and similar materials as they involve intergranular interactions such as dislocations, cracks, interfaces and surface layers, and require improved tools for their investigation. Synchrotron-based X-ray techniques have great potential to make the full, hierarchical characterisation of materials possible through the use of nanometre beams to probe sub-micron

features. The derived information can be combined with the development of computational techniques to allow the rationalisation and eventual prediction of material properties.

The ESRF has extensive experience in the high-energy, time-resolved, powder and high-pressure diffraction techniques that are vital to all of the areas detailed above.

Added value of the Upgrade

The Upgrade Programme will enable scientists to tackle experiments with smaller samples, over enhanced length scales, shorter timescales and, crucially, involving *in situ* reactions and structures under non-ambient conditions.

Scientific value will be added by the development of:

- Nanofocus beamlines for hard X-ray diffraction and imaging down to 20 nm, to study nanoscale samples under extreme conditions and complete the tools for the total hierarchical characterisation of materials.
- Sub-millisecond diffraction and imaging allowing subsecond tomography for materials dynamics.
- Routine high-pressure facilities for megabars of pressure at very high and low temperatures and a large volume press for materials synthesis and characterisation.
- A high-energy beamline for structural studies of liquids, amorphous materials and surfaces/interfaces.
- Structural dynamics with the application of improved and additional probe techniques for crystals and solutions. Experiments at the ESRF will be highly effective for timescales greater than the 100 ps range and are essential in laying the sound foundations for future experiments at the X-ray free electron laser (XFEL).

Key questions

Modern materials science and chemistry depend on an intimate understanding of a system's behaviour and structure, both of which can be explored using

synchrotron radiation over a very wide range of length scales, timescales, and under an immense variety of applied conditions.

1. How can structural and spatial information be correlated across many orders of length scale to rationalise and predict materials' physical and chemical properties?
2. Can *in situ* methods aid in the optimisation of the processing of advanced materials and chemical procedures?
3. How can the performance of car exhaust catalysts be optimised?
4. What are the chronology and kinetics of the fundamental steps in a chemical reaction sequence?
5. How do the interiors of the Earth and related planets function?

The next generation of high resolution diffraction and spectroscopic instruments available at the upgraded ESRF will offer the opportunity to investigate such concepts at the fundamental level. For materials science, the emphasis is on hard energies and focused beams.

Expected user communities

Materials scientists will be given access to superior structural information from the atomic to the micrometre scale and larger. These techniques benefit researchers studying materials fatigue, crack growth, and component failure, which in turn are relevant to welding, aerospace components, and surface treatments, etc. Through rapid *in situ* structural and spectroscopic methods (pump and probe), physicists and chemists investigating fundamental chemical pathways will obtain details of complex processes from measurements over all relevant spatial and timescales leading to a detailed understanding of the mechanisms involved. The Upgrade will promote fundamental and applied research for structural chemists that use high-resolution diffraction and spectroscopic techniques to develop new materials, *e.g.* for hydrogen storage and batteries or catalysts, or to improve pharmaceutical formulations. Through novel sample environments geophysicists will reveal the fundamental physical and geochemical properties for Earth and planetary sciences. Materials scientists developing novel, ultra-resistant materials at the forefront of technology will also profit from advanced high-pressure cells combined with laser or resistive heating.

Enabling technology and infrastructure

These scientific areas will benefit from the developments planned within the framework of the Upgrade, especially in detectors and nano-instrumentation.

- *Buildings and infrastructure*: A part of the proposed programme involves long nanofocusing beamlines. Space for new infrastructure such as specialised sample preparation and characterisation is required.
- *Accelerator and source*: This programme relies upon timing modes in top-up operation, overall machine stability and smaller source emittance. Cryogenic and canted undulators are needed. Higher flux and brilliance are an advantage.
- *Beamlines and instrumentation*: Nanofocusing beamlines are required with their associated specific stringent infrastructure issues: mechanical and thermal stability and X-ray optics. Development of extreme sample environments for routine use. Requirement for high sensitivity and high speed X-ray detectors. High levels of component integration will be needed.
- *Computing*: The programme will be particularly demanding in data storage capacity and sophisticated beamline control. Online analysis of data is essential.

Partnerships

Several networks and partnerships in microelectronics, bulk metallic glasses, high pressure, fuel cells, etc. are desirable. Collaborative access to a large-volume press is an important part of developing the technique and the user community. The FaME38 partnership (ESRF, ILL, EPSRC) provides support to enable European materials engineers to make the best use of the advanced neutron and synchrotron X-ray scientific facilities at the ILL and ESRF.

Industry and technology transfer

The Upgrade Programme is closely linked to industrial applications. The aeronautical, automotive, microelectronics and pharmaceutical industries are of particular importance; companies directly use proprietary beam time for sample analysis. The full hierarchical characterisation platform includes a proposal for a dedicated engineering beamline to cater for industrial materials analysis.

1.3.1. Introduction

Structural knowledge forms the basis of modern materials science and chemistry. The development of new materials and the optimisation of synthetic chemical processes depend on a detailed understanding of a system's microscopic structure – the arrangement of and interactions between the fundamental constituents of a system – and how these evolve, either spontaneously, or under the influence of externally applied conditions (such as changes in temperature, pressure, concentration, applied load, etc.). Synchrotron-based methods can probe structure and structural evolution over a very broad range of length scales (from the nanometre to the millimetre), timescales (down to hundreds of picoseconds), temperatures (up to thousands of degrees), and pressures (up to several megabars). Thus as well as providing methods to study, understand and improve processes and materials of technological and industrial importance, synchrotron radiation provides techniques to study matter under extreme conditions, relevant within the realms of planetary and Earth sciences.

This chapter therefore deals with the impact of the Upgrade Programme in the areas of chemistry, matter at extreme pressures and temperatures, and materials science. These closely-related areas have benefited immensely from synchrotron radiation in the past. The Upgrade Programme will provide ways of handling even more challenging problems. Routine access to nanometre sized beams and better detectors combined with the ESRF high-energy X-rays will make it possible to study individual grains, smaller samples, shorter timescales and *in situ* studies in reaction vessels and structures under non-ambient conditions.

Structural information can be effectively obtained through single-crystal diffraction, powder diffraction and EXAFS (section 1.3.2). Improved resolution in powder diffraction makes it possible to determine crystal structures *ab initio*, even from structures as substantial as protein complexes. The areas of applications are numerous: from catalytic processes to supramolecular chemistry, where atoms assemble to form large functional complexes and entangled structures. The Upgrade will markedly improve the possibilities by providing faster acquisition times and expanding the capability to include liquids, amorphous materials and quasi-crystals.

Structural chemical information is also important when broken down along the timescale so that reactions can be followed (section 1.3.3). Pump-and-probe techniques allow chemical reactions to be "filmed" to provide records of molecules in action. The ESRF beamlines will provide a highly effective resource for time resolution greater than 100 ps

complementary to the XFEL experiments on the femtosecond timescale. The time-resolved structures of both large and small molecules in crystals and in solution using crystallography, SAXS and spectroscopies will be accessible using the improved techniques and facilities provided by the Upgrade Programme.

Pressure and temperature are thermodynamic variables that cause changes in states and drive chemical reactions (for example, hydrogen at extreme pressures is predicted to become metallic).

Section 1.3.4 describes the physics and chemistry of matter at extreme conditions. Demand continues to grow steadily for high-pressure experiments in a number of areas such as Earth and planetary science, fundamental physics, mineralogy and the synthesis of new materials under non-ambient conditions. This is due to the breakthrough in diamond-anvil cell technology, coupled with the well-collimated X-ray beam from the ESRF (a micrometre-sized beam is required given the cell acceptance). The Upgrade Programme will allow extended extreme conditions to be routinely applied at the ESRF beamlines and an increase in capacity for high-pressure experiments.

The discipline of materials science (section 1.3.5) looks at the relationship between the structure and properties of materials, which forms the basis for designing new engineering materials. In order to understand this relationship, their structure has to be studied on a variety of length scales from the atomic (sub-nanometre) to the bulk scale (millimetres). This knowledge has clear relevance for industry and, as part of the Upgrade, a bending magnet beamline dedicated to industrial materials science is planned. Knowledge of how materials react under stress or under the influence of varying environmental conditions is also of paramount interest (*e.g.* for the aerospace industry). The unifying objective is to provide a set of beamlines that covers the entire range of length scales (angstroms to micrometres to millimetres) and time (sub-milliseconds to hours to even weeks).

1.3.2. Chemical crystallography and structural chemistry

Understanding the properties of materials requires knowledge of their structure at the atomic level. This is best obtained via single-crystal diffraction measurements if the material forms suitable crystals, which is frequently not the case for modern materials systems or for novel chemical compounds made by innovative synthetic routes. Synchrotron-based techniques allow materials to be characterised irrespective of their state of crystallinity via different

diffraction and spectroscopic methods. These reveal long-range or local structural details for glasses, liquids, poor-quality crystals (perhaps of great fragility preserved in mother liquor), powders (which can be multiphase), assemblies of microcrystals, adsorbed surface layers, etc. Moreover, the evolution of structure with materials processing or changes in conditions is also an important feature of a system that needs to be investigated and understood. The improvements in X-ray flux and detectors foreseen within the Upgrade Programme mean that structural characterisation will be possible with increased detail and accuracy, and on greatly reduced timescales. This will allow ever more rapid and/or complex processes to be studied.

Atomic-scale structure of materials

Determining the highly complex structures of the new class of compounds formed by self-assembly mechanisms, such as organometallic grids and supramolecular arrays, represents a real challenge. The structures are important as they verify the success of the underlying synthetic strategy as well as revealing the influence of weak chemical forces, *e.g.* hydrogen bonding, van der Waals interactions, etc. The crystals are usually small, fragile, and of broad mosaicity. Solving such structures entails determining thousands of parameters and is quite impossible with conventional instrumentation. Numerous materials of this kind have been characterised using beamline ID11: the quality of the beam allows the collection of so much data, of such statistical quality, simply to overwhelm the problems and hence lead to the solution of the structure (*e.g.* Barboiu *et al.*, 2003). A novel crystallographic approach involves collecting data from an assembly of microcrystals. By using a focused beam, only a few crystallites are irradiated and diffract. Software to track the individual crystallites as they are rotated in the beam allows the collection of a single-crystal-like pattern from essentially a few grains of powder, so enabling complex and robust refinements. Within the Upgrade Programme, this approach will be generalised and its applicability extended greatly. Atomic-level structure represents the base length scale of "simultaneous hierarchical characterisation," described in section 1.3.5. When reasonable single crystals are available, the superb data allow the study of fine details such as electronic structures, anharmonic motion, commensurate or incommensurate charge ordering, charge-density waves and other superstructures, etc.

The analysis of crystal structures from powders requires accurate high resolution data extending to small d-spacings with good statistics that are optimally collected at a short wavelength, using a parallel-beam diffractometer. Many of the most

complex systems studied as powders in recent years have used ESRF facilities. Figure 1.3.1 presents an organometallic structure as an example, and there has also been recent work on proteins. Powder measurements are, however relatively slow. It takes many minutes or even hours to obtain a pattern that is adequate to determine and refine a structure with any level of complexity, especially if using a technique that exploits multiple data sets. The novel use of anisotropic thermal expansion to change the degree of overlap between adjacent peaks, thus yielding better estimates of their individual intensities can be given as an example. Multipattern techniques are being increasingly employed for the most complex structures solved or refined from powders.

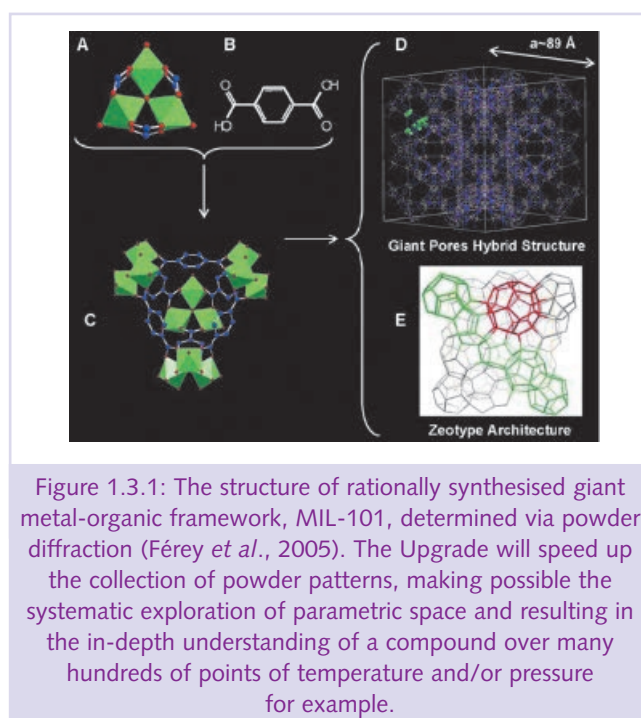

From G. Férey, C. Mellot-Draznieks, C. Serre, F. Millange, J. Dutour, S. Surblé, I. Margiolaki, A Chromium Terephthalate-Based Solid with Unusually Large Pore Volumes and Surface Area, *Science* 309, 2040-2042 (2005). Reprinted with permission from AAAS.

Powder diffraction is a powerful method for following the structural evolution of a system using changes in temperature, composition, time, etc., for example the characterisation of the phase transitions of a compound, or studying a battery during the electrochemical cycle. A modern development involves making measurements at many points (*e.g.* temperatures), even at hundreds of points if appropriate. The detailed evolution of the structure can then be observed, revealing the underlying mechanism. Such "parametric studies" provide a wealth of information about the evolution of crystalline systems, *e.g.* the details underlying the negative thermal expansion of a material. Modern Rietveld programs allow structural parameters to be tied across the series of patterns by empirical or theoretical relationships. The refinement can therefore take place against a 3D surface (*e.g.* intensity versus 2θ and temperature), which makes it possible to refine fundamental quantities that are not normally

accessible in a simple analysis. For example, rather than refine the lattice parameters for each temperature, it is possible to refine the thermal expansion coefficients which define them instead.

There is, however, a major mismatch between the time required to obtain a powder pattern for the analysis of a structure of moderate complexity and the number of points for an effective parametric study of a system. At the ESRF, it is currently impossible to measure 200 high-resolution powder patterns for a sample. However, this would become realistic by accelerating the measurements by an order of magnitude. Such an increase in performance will result from the improvements to the source and detectors foreseen in the Upgrade Programme, thus extending the utility of parametric analysis. Furthermore, the general area of powder crystallography will be enhanced, particularly for the most complex structures requiring a multiple-data-set approach. An approach which is also increasingly exploited in modern chemical technology is the characterisation of a large number of compounds formed by systematic variations in the conditions of synthesis.

Materials lacking strict long-range order, *e.g.* glasses, liquids, quasi-crystals, assemblies of nanoparticles, aperiodic or disordered systems, etc., can undergo structural analysis via the atomic pair distribution function (PDF, the Fourier transform of the normalised powder diffraction pattern) or EXAFS spectroscopy. Peaks in the PDF represent characteristic distances between pairs of atoms in the structure (Billinge and Kanatzidis, 2004). A theoretical PDF can be calculated from a model, such as the postulated structure for a nanoparticle, and compared with the experimental curve. By minimising the differences between the two, the model can be refined in a manner analogous to the Rietveld method. It is even possible to access multicomponent materials using this approach, and recently the structure of a nanoparticle cluster of atoms was solved via the PDF without prior structural information. The increasing number of proposals received at the ESRF illustrates the growing interest in PDF analysis. The Upgrade Programme will benefit the measurement of high quality PDFs by accelerating the data collection by at least an order of magnitude, thereby also encouraging *in situ* studies. Moreover, the improved hard energy performance will promote the use of anomalous scattering studies at energies above 40 keV, allowing better contrast for heavy elements, such as in rare-earth-containing glasses, and materials with important optical properties. Such studies would be complementary to studies via EXAFS.

X-ray absorption spectroscopy (XAS) is an essential probe for determining local structure around selected atomic species, even when in very dilute

concentration. In addition, high-energy-resolution edge measurements provide unique information on the nature of the lowest unoccupied electronic states (van Bokhoven *et al.*, 2006). XAS is also well suited for experiments under extreme conditions. Improvements to the XAS technique in terms of acquisition time and spot size will largely expand the thermodynamic region where it will be possible to probe the local structure of liquids, *e.g.* at the equilibrium or in the metastable undercooled phases.

Solid-state chemistry

Solid-state chemical reactions can be followed *in situ* by powder diffraction techniques, *e.g.* to identify intermediate steps in the synthesis or processing of a material, perhaps under conditions close to those used in a real industrial process. For the fastest reactions, such as self-propagating combustion synthesis, where the reactions last only a couple of seconds, a time resolution of a few milliseconds is needed. Here time resolution takes precedence over angular resolution or range, and a fast 2D detector (*e.g.* the ESRF FRELON camera, *see* chapter 2.5) must be employed. A small (focused) beam is essential as this ensures the highest angular resolution of the diffraction pattern, and gives the clearest picture of the chemical changes within a small volume of the sample. Evolution towards routine smaller beams will improve such measurements, because the homogeneity of the chemical processes within a smaller irradiated volume increases and so does the capacity to resolve the individual steps in any reaction sequence. For studies on a slower timescale, the improvements foreseen for high-resolution measurements (*see* above) will assist the convergence of the different *in situ* approaches.

Absorption of organic molecules at surfaces

The investigation of the physical and chemical properties of large molecules and molecular assemblies on surfaces is of considerable importance because of the technological possibilities of devices based on organic films. Adsorption can induce conformational changes, causing modifications in the chemical and physical properties of the interface, which play a major role in the performance of devices. The interaction of large molecules with surfaces is a complex balance of intermolecular binding forces and molecule–substrate interactions which may induce either displacive reconstruction involving strong mass transport of the substrate atoms or a complicated modification of the adsorbed molecules.

Large molecules interacting with metal or semiconducting surfaces have been widely studied by scanning tunnelling microscopy (STM). This is a

technique that provides images of the molecular electronic states on surfaces with near-atomic resolution. However, STM cannot directly detect the adsorbate–substrate interface and the induced substrate modifications must be inferred indirectly. Surface X-ray diffraction gives access to this important and complementary information by providing a detailed structural description of the substrate–adsorbate interaction. The availability of small X-ray beams together with the possibility of energy scans and the use of 2D pixel detectors opens new possibilities for studying such systems. If the choice of X-ray energy is made wisely, radiation damage induced by photoelectrons can be minimised, whilst limiting the exposure thanks to the 2D detector. The possibility of using coherent beams will give access to photocorrelation spectroscopy measurements and, subsequently, to the dynamic properties of such systems.

1.3.3. Fundamental chemical reaction processes

Rational chemical synthesis requires detailed understanding of the mechanism and kinetics of reactions, *i.e.* the sequence and rate of the fundamental processes of electron transfer, bond making and breaking, transport of reactants and products, etc. Such knowledge allows new synthetic routes to be designed, and old ones to be optimised to give higher yields, or to proceed under milder (more energy efficient or more environmentally compatible) reaction conditions. A key factor in many reactions is the role played by the catalyst in providing an efficient route from reactants to product, and the study of the mechanism of catalysts is an important theme at the ESRF. The Upgrade Programme will make it possible to study faster processes with greater sensitivity under a wider range of conditions, which will provide an improved insight into basic chemical reactions. These will be coupled with a host of complementary spectroscopic techniques to allow the detailed picture to emerge.

Investigation of reaction pathways and catalysis

A key objective in chemistry is to understand the mechanism of chemical reactions at the atomic level. This has major practical implications for the design and optimisation of bulk processes, comprising about 80% of industrial chemical reactions. In addition to improved efficiency and environmental concerns, understanding reaction mechanisms is essential for providing technologically advanced products. Unravelling the chemical behaviour of a system is a real challenge owing to chemical heterogeneity and

the sensitivity to external conditions (temperature, pressure, gas conditioning, etc.). Inner-shell spectroscopy using hard X-rays is a key technique in doing this because it is element specific and compatible with various sample environments. Advancing the characterisation of chemical processes on a variety of length and timescales, and to relate structural and electronic changes to other parameters of the process (*e.g.* performance, interconversion of molecular species), will be achieved within the framework of the Upgrade Programme in the following areas:

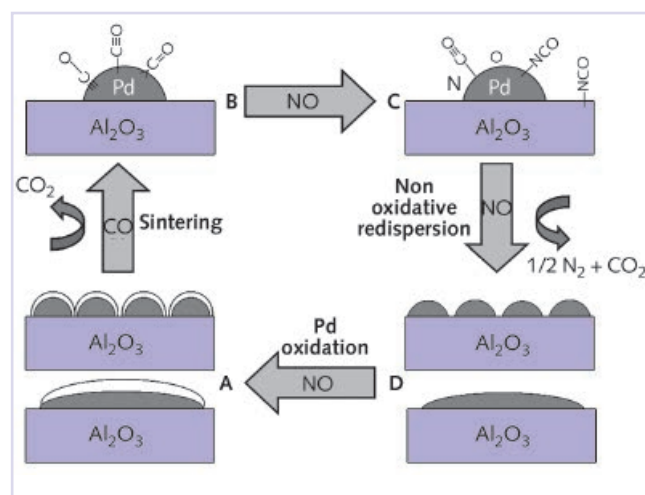

Figure 1.3.2: Elucidation of a new structural reactive catalytic cycle occurring in Pd catalyst during cycling between CO and NO feedstocks at 673 K. The complete picture is only obtained by applying dispersive EXAFS, infrared, and mass spectrometry synchronously, at a time resolution of 4 Hz (Newton *et al.*, 2007). Each spectroscopy complements the others to reveal a complete picture of the catalyst's behaviour – the Upgrade will advance the use of combined *in situ* spectroscopies, which, when combined with smaller beams/detectors, will also improve spatial and time resolution.

• Synchronous spectroscopy

Different spectroscopic techniques provide complementary information (Figure 1.3.2). Several techniques can be applied simultaneously, such as EDXAS/IR/Raman/mass spectrometry or EDXAS/UV–Vis/IR. If this is combined with a time resolution down to a few milliseconds, a wealth of information on a chemical reaction is obtained. The configuration of occupied electron orbitals can be studied with X-ray emission spectroscopy (XES) where little work has been done to date. The XAS–XES combination is intriguing because structural changes can be directly related to changes in the electron configuration.

• *In situ* spectroscopy

When monitoring a chemical reaction, it is crucial to apply a change in the environment online. An *in situ* cell able to provide realistic working conditions and

Reprinted by permission from Macmillan Publishers Ltd: Nature Materials, Newton M.A., Beyer-Coldeira C., Martinez-Arias A., Fernandez-Garcia M. Dynamic *in situ* observation of rapid size and shape change of supported Pd nanoparticles during CO/NO cycling. 6, 528–532, copyright 2007. <http://www.nature.com/nmat/>

allow the simultaneous applications of numerous techniques presents a considerable engineering challenge.

- **X-ray emission spectroscopy (XES) and resonant inelastic X-ray scattering (RIXS)**

These relatively new additions to the catalogue of spectroscopic techniques offer new insights into chemistry and chemical processes by studying occupied electron orbitals just below the Fermi level, as well as low-energy (optical) excitations by a hard X-ray probe. Overcoming current restrictions by increasing the energy resolution and obtaining sub-second time resolution are challenges that, once resolved, will have a major impact.

A smaller beam creates potential for improved time and imaging resolution. However, it must be taken into account that many chemical and biological systems (especially in solution) can be X-ray labile (thermal or electron induced damage). Increased vigilance to accommodate these effects is therefore required. In this respect, the ESRF aims to provide the expertise and all-embracing facilities needed for sample characterisation. This will make the ESRF attractive to a wider user community.

Structural and electronic characterisation of complex species bound to surfaces

Understanding heterogeneous catalysis requires knowledge of the interactions between a surface and an adsorbed species. Synchrotron-based techniques have been employed to acquire this knowledge, *e.g.* EXAFS for local order determination or surface diffraction for crystallographic and morphological characterisation. The ESRF has pioneered efforts to bridge the gap between idealised experiments under UHV and catalytic reactions at more realistic pressures and temperatures, *e.g.* by providing new information on adsorbate-adsorbate and adsorbate-metal interactions at relatively high pressures up to 1 bar and elevated temperatures. It has been shown, for example, how the role of the metal oxide phase for CO oxidation is important, contrary to the general belief that the oxide was a pollutant and inhibitor of the reaction.

A real catalyst is composed of nanoparticles and XRD provides significant insights into the growth mechanisms of particles appropriate for catalysis.

In situ studies show how the particles change structure and shape during the reaction. Such studies are still limited to an average over an ensemble of particles simultaneously illuminated by the beam.

A breakthrough would be the study of single particles during the reaction. Thus the availability of nanometre X-ray beams will make the determination of the morphology of single nanoparticles feasible via

coherent diffraction imaging. It will be possible to zoom in from illuminating a large number of clusters, thus determining their average structure and morphology, to a condition where only the diffraction from a single particle is observed (Williams *et al.*, 2003). Using a fast 2D pixel detector and performing an energy scan will make it possible to measure the interference fringes due to the particle's finite size and to determine its 3D shape. The studies will be carried out *in situ*, varying the temperature and exposing gases while monitoring the reaction products. In this way, particles' interactions with the gases and the phenomena leading to the eventual decrease in catalytic activity will be understood. The proposed acquisition procedure will allow a dramatic increase in the time resolution of the experiment, from minutes at present to sub-second, particularly relevant for fast reactions. The same principle can also be coupled with an energy scan maintaining a particle in the Bragg condition in order to perform a diffraction anomalous fine structure (DAFS) experiment. In this case, complementary information gathered through XAS will be available and will be advantageous because it obtains the signal from a single particle.

The Upgrade will therefore enable a tremendous improvement in the comprehension of surface catalytic processes by making nanometric beams available and energy scans possible. Experimental chambers will also host other experimental techniques, such as local probe microscopy or light spectroscopy.

Relevant Conceptual Design Reports:

- **EDXAS-L:** Energy Dispersive Absorption Spectroscopy (large spot)
- **EXAFS:** Extended X-ray Absorption Fine Structure Spectroscopy
- **SURF:** Surface Diffraction
- **XAS-XES:** Steady-State and Time-Resolved X-ray Absorption and Emission Spectroscopy

Key enabling technologies and infrastructures:

- **Detectors:** For EDXAS-L, 2D as FRELON but larger horizontally and faster – *i.e.* 10 μ s dead time (direct detection like XSTRIP eventually).
- **Buildings:** Optical schemes of EDXAS-S and EDXAS-L are linked. One of the two experimental stations could be external to the experimental hall.
- **Infrastructure:** Chemistry laboratory close to the EDXAS-L beamline.

Structural dynamics

Studying chemical and biological reactions at atomic resolution and on timescales fast enough to follow the evolution of molecules from their initial structure through intermediates to their final structure is a great experimental challenge. The experimental probe has

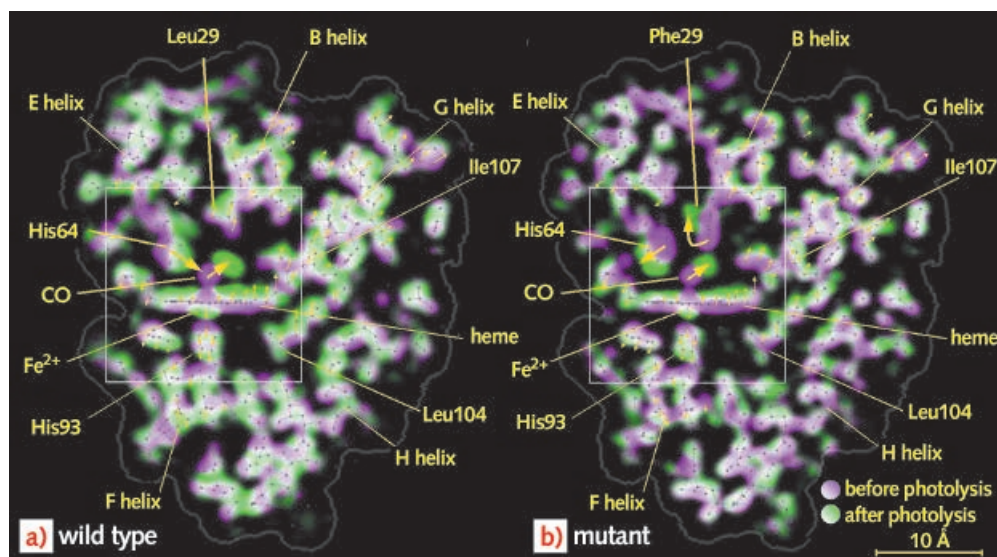

Figure 1.3.3: Snapshots of the protein quakes in wild-type and mutant (L29F) myoglobin observed 100 ps after the dissociation of CO. The Upgrade will permit similar experiments to be envisaged with larger and more complex proteins and on a shorter timescale. This work helps to form the foundations of the techniques and instrumentation to be used in the XFEL experiments probing timescales faster than 100 ps.

Reprinted from *Journal of Structural Biology*, 147, F.Schotte, J.Soman, J.S.Olson, M.Wulff, P.A.Arnfinrud, Picosecond time-resolved X-ray crystallography: probing protein function in real time, 12, Copyrights 2004, with permission from Elsevier

to be extremely fast since reactions unfold on timescales from femtoseconds to seconds, and the reactions have to be activated quickly and uniformly by an external trigger. The information that could be gleaned from such studies is the identification of the participating atoms, the timespan, and the role of the environment. Further information of interest relates to the chemical state of the atoms, whether it changes, the number of intermediate states that occur, their lifetime and their decay path.

Nature provides us with many examples of efficient reaction mechanisms using external energy sources such as visible light or heat. If the structural and chemical changes are understood they can ultimately be emulated for use in large-scale applications. Metalloenzymes, for example, catalyse important chemical reactions in living organisms. The activity of a metalloenzyme is determined by its three-dimensional structure as well as by the chemical state of the metal ion. Whilst the former can be studied by X-ray diffraction, the latter is better accessed by an element-specific technique such as inner-shell spectroscopy.

Synchrotron pump-and-probe experiments will form the basis for and be complementary to future XFEL experiments. The extreme XFEL intensity will produce excellent scattering and diffraction patterns in a single shot at the cost of destroying the sample. It is therefore anticipated that synchrotron radiation will remain superior to XFELs for slower dynamics, *i.e.* timescales above 100 ps. Experience gained from pump-and-probe experiments at the ESRF is laying the foundations for future XFEL experiments on the femtosecond timescale.

Two dedicated pump-and-probe beamlines are described below, one for scattering and diffraction and the other for spectroscopy, together with the new

science that they will enable. The Upgrade Programme is essential for their funding, and for the development of fast 2D detectors (*see* chapter 2.5).

• Filming proteins in action

Undulator beams at the ESRF are so intense that diffraction patterns from proteins can be recorded with one X-ray pulse. This has been used to film protein motions to a time resolution of 100 ps. The protein is typically activated by femtosecond laser pulses, and the evolving structure is probed by Laue diffraction from delayed X-ray pulses. When Fourier difference maps from a series of time delays are combined, the correlated motions of all of the atoms in the unit cell are literally filmed in real time and in three dimensions. Figure 1.3.3 shows the structure of wild-type and mutant myoglobin measured 100 ps after dissociation of CO. The ground state is magenta, the photolysed state green, and the direction of motion follows the magenta-to-green colour gradient. Structure-function relationships in smaller proteins have been studied in this and similar films and it has been possible to correlate structural changes in great detail (Schotte *et al.*, 2004).

Within the framework of the Upgrade Programme, larger and more complex proteins will be studied. New picosecond lasers and advanced 2D detectors mean that it will become possible to investigate larger and biologically important proteins such as photosynthetic protein complexes (*see* below). Protein activation is currently done with 100 fs laser pulses for technical reasons, but the high peak power makes it impossible to excite more than 10 to 20% of the unit cells without radiation damage. If the laser pulses are stretched to 10 ps, the peak intensity becomes 100 times lower and the entire protein can be excited without radiation damage. Because the signal-to-noise is proportional to the number of

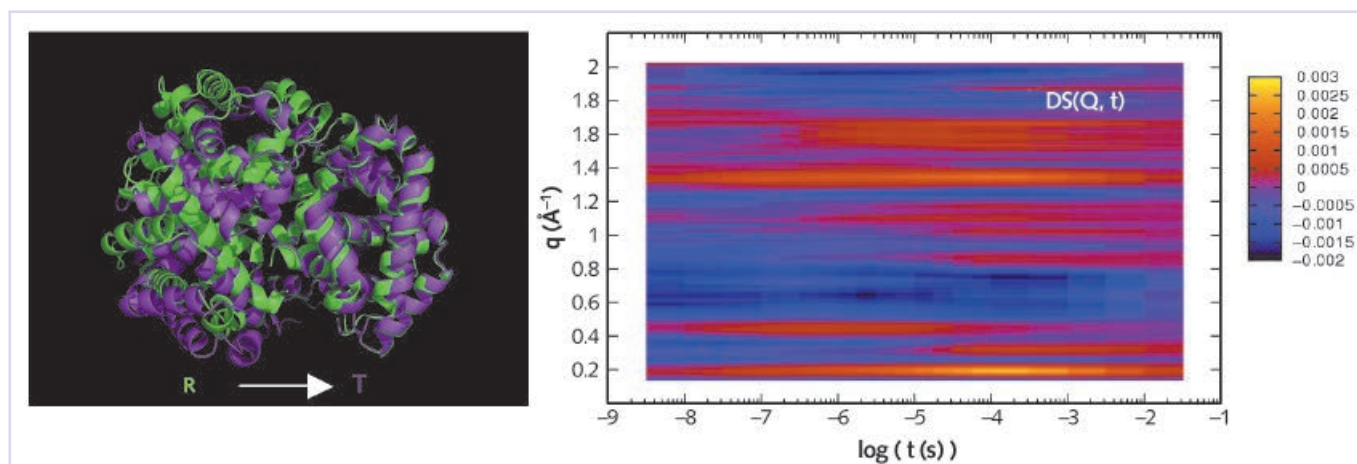

Figure 1.3.4: The R (green) to T (purple) transition in haemoglobin induced by photo-dissociation of CO. Contour map of the associated change in scattering. The local tertiary transition is instantaneous whereas the global R to T transition is delayed by 30 μ s as seen by the appearance of red stripes at 0.33 \AA^{-1} and 0.90 \AA^{-1} . This pilot study forms the basis for further developments of this technique to study protein dynamics in solution within the framework of the Upgrade Programme.

excited unit cells, a dramatic increase in the information content is expected with films at higher resolution.

Protein dynamics in solution are particularly important since most proteins function in solution. In the near future, new time-resolved SAXS/WAXS techniques will allow the measurement of protein shape changes during biological reactions. The proteins will be initiated by photolysis or infrared temperature jumps, the latter being important for protein folding. In order to test the feasibility of pump-and-probe SAXS/WAXS experiments in solution, the relaxed (R) to tense (T) transition in the haemoglobin complex HbCO was recently studied on beamline ID09B. This transition, which involves a 15° rotation of the $\alpha\beta$ dimers and a 1 \AA displacement along the rotation axis, lowers the oxygen binding affinity by a factor of 300. The induced change in scattering, $\Delta S(Q, t)$, shows how the dissociation produces a small structural perturbation that generates stress in the protein on the nanosecond timescale. The stress is released after 30 μ s which drives the R to T transition, which is an example of how dissociation in one subunit catalyses dissociation in the others (see Figure 1.3.4). Within the Upgrade Programme, a SAXS/WAXS option will be added for proteins with a variable length vacuum chamber between the sample and the detector.

In most cases, metalloenzymes contain a 3d transition metal that is at the centre of the bio-catalytic reaction. X-ray spectroscopic studies performed on single crystals or solutions provide information on the local coordination and electronic structure of the metal ion. X-ray absorption (XAS) is sensitive to the ligand environment while X-ray emission (XES) directly probes energy levels and symmetries of electron orbitals (Glatzel and Bergmann, 2005; Glatzel *et al.*, 2005). Owing to its strong sensitivity to

electron–electron interactions, XAS-XES also gives direct evidence for the spin-state in the valence shell which is related to the metal ion oxidation state. XAS-XES can therefore address not only structural changes but also electron transfer and spin-dynamics in, for example, haem-containing proteins and molecular complexes.

Many relevant systems, however, have metal concentrations that are below the current detection limit for time-resolved XAS-XES. It is of paramount interest to make time-resolved X-ray spectroscopy accessible to these systems by improving the signal-to-background ratio. An important example addresses one of the most fundamental reactions on Earth: the production of dioxygen in higher plants and cyanobacteria (Yachandra *et al.*, 1996). A new intermediate state (S_4') has been proposed based on time-resolved X-ray detection at fixed absorption energy (Haumann *et al.*, 2005). However, until now, it has not been possible to record a full, time-resolved X-ray absorption near-edge (XANES) spectrum because of poor signal-to-background ratios. A wavelength-dispersive setup for fluorescence detection will dramatically improve the data quality and allow detection of the full XANES spectrum with the required time resolution to study the elusive S_3 to S_0 transition (cf. Figure 1.3.5 and section 2.3.6).

In general, electron transfer reactions in proteins occur on timescales ranging from sub-picoseconds to milliseconds with a large number of relevant reactions occurring in the nanosecond and millisecond range (Figure 1.3.5). For naturally non-photoactive proteins, a photosensitiser (*e.g.* Ru complexes) can be added that acts as a trigger to initiate the electron transfer processes. Structural modifications that occur during the reaction can be disentangled from changes in the electron configuration by comparing XAS with XES.

Reprinted from F.A. Tezcan, B.R. Crane, J.R. Winkler, and H.B. Gray, Electron tunnelling in protein crystals; Proc. Natl. Acad. Sci. USA, 98 (9), 5002-5006 (2001). Copyright 2001 National Academy of Sciences, U.S.A.

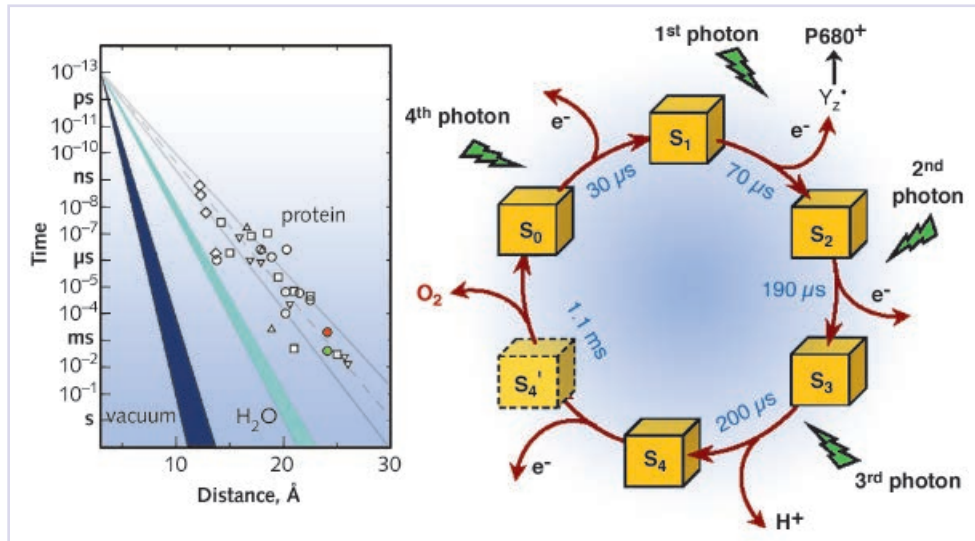

From M. Haumann, P. Liebisch, C. Müller, M. Barra, M. Grabolle, H. Dau, Photosynthetic O₂ Formation Tracked by Time-Resolved X-ray Experiments, Science 310, 1019-1027 (2005). Reprinted with permission from AAAS.

Figure 1.3.5: Left: Tunnelling timetable for electron transfer in various Ru-modified metalloproteins (open symbols) and for inter-protein time constants (coloured circles) (Tezcan *et al.*, 2001); Right: Transition times in the biocatalytic cycle of the oxygen evolving complex in the photosystem II protein complex (Haumann *et al.*, 2005).

Time-resolved X-ray spectroscopy on metalloenzymes will thus give a fundamentally new insight into biocatalytic reactions.

The Upgrade Programme will make it possible to perform diffraction and scattering as well as spectroscopy experiments on the same system at the ESRF. The photosynthetic reaction centre is a good example of a complex protein whose studies will benefit from the Upgrade Programme. The dynamics of the conformational changes in the protein complex can be correlated to chemical and structural changes at the active site. Should this venture prove successful, an important step towards unravelling the photosynthetic reaction cycle could be achieved, which would lead to a better understanding of how light can be harvested to drive chemical reactions.

• Dynamics of smaller molecules in solution

The first studies of the formation and breakage of chemical bonds were made on halogen molecules such as Br₂, I₂, (and HgI₂) in solution by optical pump-and-

probe spectroscopy with picosecond and later femtosecond time resolution. By probing changes in the electronic structure, the timescale of reaction steps was determined, but the long wavelength of optical light excluded any spatial information. In contrast, X-ray scattering and spectroscopy probe the distance distribution between pairs of atoms, within and between molecules. As the 100 ps time resolution offered by synchrotrons cannot resolve the transition between structures, the experimental patterns reflect the time-dependent concentration of intermediate structures.

The spectroscopic and scattering signatures for putative intermediates can be calculated by combining quantum chemistry with molecular dynamics and fitted to the data. Finally, the hydrodynamics of the solvent, *i.e.* the density, temperature and pressure as a function of time, can be determined from the high-*Q* part of the scattering function $S(Q, t)$ (Wulff *et al.*, 2006). The photo-induced change in radial scattering and electron density for bond breakage and bond formation of I₂ in CCl₄ is shown in Figure 1.3.6.

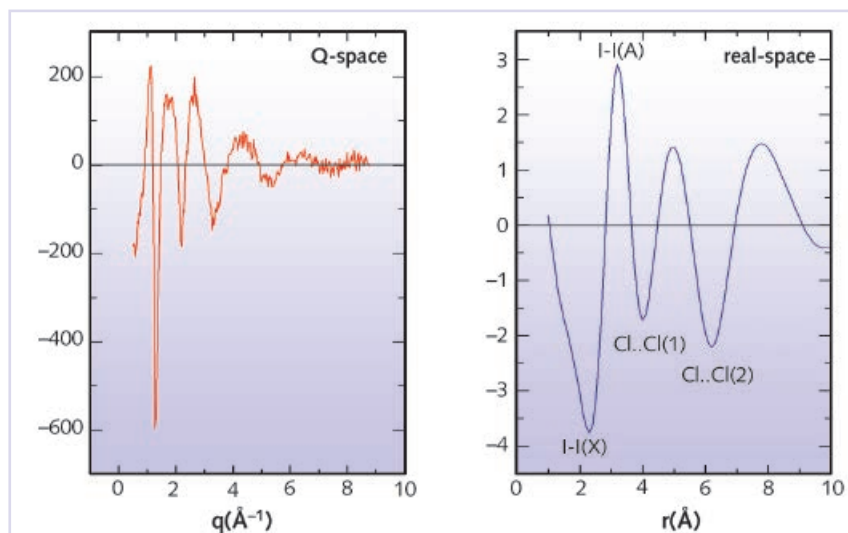

Figure 1.3.6: Signatures from the breakage and formation of bonds in a solution of I₂/CCl₄ in Q-space and real space. The data were taken 100 ps after excitation. The I₂ dissociation hole is seen at 2.5 Å and the formation of the spin-1 state appears at 3.2 Å. The oscillations above 4 Å are from a temperature rise in the solvent driven by recombining iodine atoms. The development of a beamline for time-resolved spectroscopy on more complex molecules forms a key aim of the pump-and-probe part of the Upgrade Programme (see CDR XAS-XES).

The study of more complex molecules with more degrees of freedom will become possible thanks to the advancements enabled by the Upgrade Programme. The complex of metal ions with a crown-ether-linked merocyanine is an example of a molecule that can temporarily release ions upon photo-excitation, which, in turn, can trigger intracellular processes (Martin *et al.*, 1996). For example, the ejection of Sr^{2+} cations is driven by electron transfer from the nitrogen in the crown to the other side of the molecule, see Figure 1.3.7. The nitrogen region becomes positively charged and forces Sr^{2+} into solution. Optical spectroscopy indicates that the cation is ejected in 400 ps and that it recombines diffusively in 2 ns. This hypothesis can be tested directly by X-ray scattering and spectroscopy, but the first experiments failed due to low concentration and weak solvent contrast. A tuneable picosecond laser and more intense X-ray beams will mean that the concentration of molecules in the excited state will increase and the dissociation signature should be easy to verify. The combined use of scattering and spectroscopy and the instrumental upgrades presented in chapter 2.3 will have a dramatic impact on the information content in general and allow the excited state structures to be refined to milliangstrom precision.

Relevant Conceptual Design Reports:

- TRD: Time-Resolved Diffraction and Pump-and-Probe
- XAS-XES: Steady-State and Time-Resolved X-ray Absorption and Emission Spectroscopy

Key enabling technologies and infrastructures:

- Detectors: Conventional CCD detector with a 200 mm diameter detection area. Pixel detector of liquid experiments with energy (0.5 keV) and time resolution (100 ns). Avalanche photodiodes for time-resolved spectroscopy.
- Buildings: The pump-and-probe beamlines do not need to be longer than 70 m. The experimental hutch should be approximately 15 m long with suitable lateral space for a parallel laser hutch and spectroscopy lab.
- Infrastructure: The beamlines need laboratory facilities for chemistry and spectroscopy with a second picosecond laser, and a sample-mounting laboratory.
- Computing support: for modelling of inner-shell spectra (*e.g.* time-dependent density functional theory or ligand field multiplets).

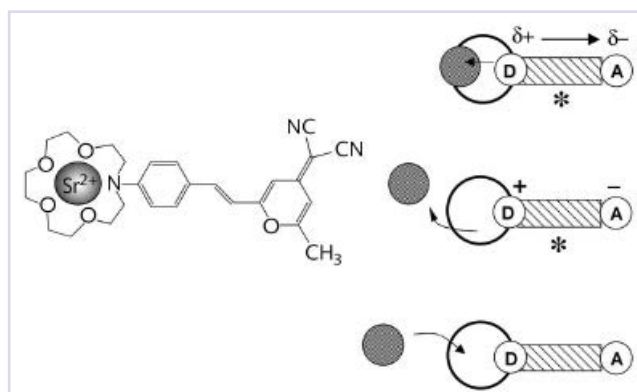

Figure 1.3.7: The crown ether-linked merocyanine molecule complexed with strontium ($\text{SrC}_{27}\text{H}_{31}\text{O}_5\text{N}_3$). Photo-induced electron transfer generates a repulsive force that ejects the Sr^{2+} cation in 400 ps. The cation recombines diffusively in 2 ns. The more intense X-ray beam and a tuneable picosecond laser enabled by the Upgrade Programme will allow detailed X-ray spectroscopy studies of complex molecules such as this.

1.3.4. Matter at extreme pressures and temperatures

When altering the physical properties of matter, the use of pressure is as fundamental as varying temperature or chemical composition. Pressure is central to fundamental studies of matter as well as being applied to real systems such as Earth/planetary science and the synthesis of new materials. Earlier limitations have been overcome by breakthroughs in diamond-anvil cell technology and large-volume cells. The diamond-anvil cell is small enough to fit in the palm of your hand, yet powerful enough to generate impressive multi-megabar (one megabar = 100 gigapascals ~ one million atmospheres) pressures. Diamonds are transparent for a wide range of electromagnetic radiation and the physical properties of matter *in situ* at high pressure and over a wide temperature range can be probed with various diffraction and spectroscopic techniques to explore fully the effects of the pressure and temperature variables. Large volume presses, with a substantially larger and better controllable sample volume, provide additional and complementary information. Furthermore, the development of laser-heating setups has allowed a substantial increase in the investigated temperature range compared to resistively-heated pressure devices.

Whilst X-ray diffraction is still the most widespread synchrotron radiation-based technique, the advent of third-generation synchrotron sources allows the application of several spectroscopic methods to high-pressure studies. These spectroscopic methods are also capable of monitoring dynamic processes (such as

materials synthesis). They offer unique possibilities in the study of the electronic and magnetic structure, lattice dynamics as well as elastic and thermodynamic properties under extreme conditions.

In the following sections, several examples have been chosen to demonstrate the expected advances made possible by the Upgrade Programme.

Fundamental physics at high pressure

Unexpected physical behaviour at ultra-high pressures has been the rule rather than the exception in the large number of materials investigated. The search for such phenomena begins logically with hydrogen. Hydrogen is the most abundant element in the universe and with only one electron per atom the most difficult to study at pressure.

At low pressures and temperatures, hydrogen crystallises as an insulating molecular solid, with strong covalent molecular bonds and weak intermolecular interactions. Molecules are freely rotating, resulting in a nearly spherical charge distribution similar to rare gas atoms. It was recognised early on that, at high compression, the two electrons of the hydrogen molecule should delocalise, resulting in the dissociation of the molecule and the formation of a monoatomic metallic solid. Experimental verification has not yet been carried out, although recent advances in high-pressure and high-temperature technology mean that the required conditions are becoming closer to being met.

The structural behaviour of hydrogen has been studied with energy-dispersive single-crystal diffraction and, more recently, with monochromatic diffraction. Results collected at ambient temperature to 150 GPa are shown in Figure 1.3.8. The present studies are mainly limited to the determination of the unit cell parameters as a function of pressure (Loubeyre *et al.*, 1996). The data show a substantial decrease in the ratio between the hexagonal c and a

lattice parameters with decreasing volume, implying some deviation of the molecules from spherical symmetry. The intramolecular distance, which is expected to increase due to weakening of the intramolecular bond when approaching metallisation, cannot be accurately determined. This is a result of the limited access to reciprocal space and to unreliable measurement of intensities. New ways of supporting diamond anvils (see section 2.4.2), resulting in substantially larger opening angles, will significantly increase the size of accessible reciprocal space. Currently, unreliable intensities are related to the weak signal combined with a huge background. Here, new area detectors (see chapter 2.5) can considerably improve the detection of very weak signals. These improvements are also needed for solving the structures of spectroscopically observed high-pressure modifications (Mao and Hemley, 1994).

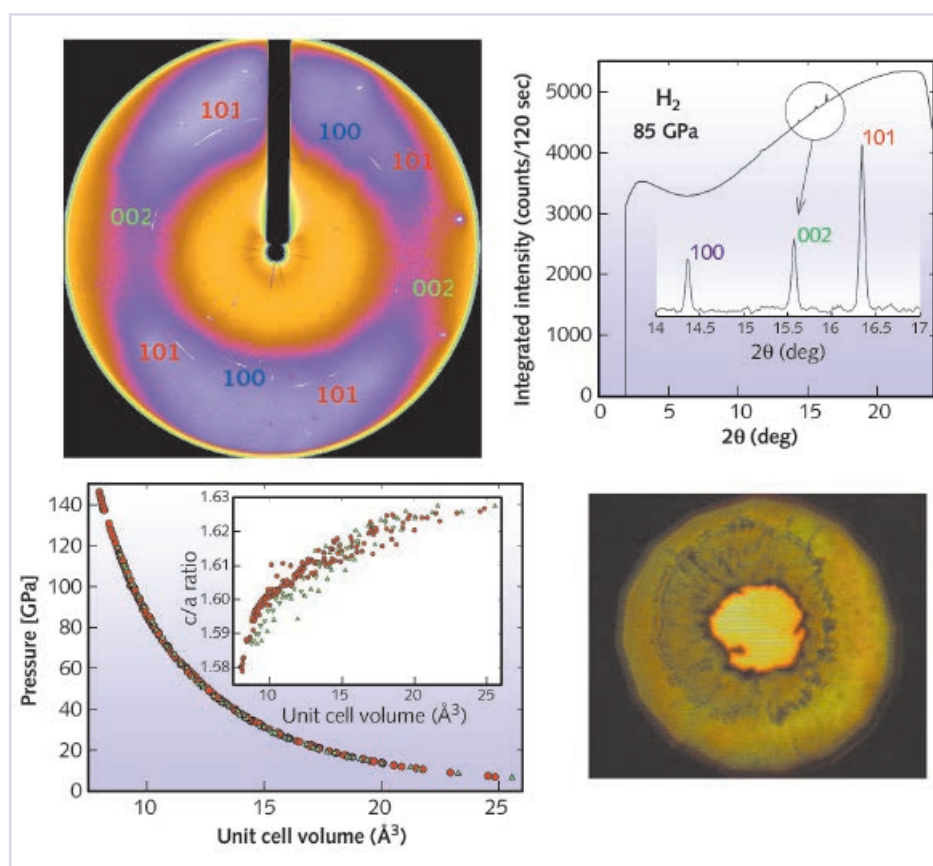

Figure 1.3.8: Hydrogen diffraction at extreme pressures: diffraction image at 85 GPa (upper left) and pseudo powder pattern after integration of the two-dimensional image (upper right). Only the three main reflections of the hcp-structure are observed. The small high symmetry unit cell means that higher-order reflections are outside the opening angle of the diamond cell. The pattern is dominated by a huge background resulting from Compton scattering from the diamond anvils. Ambient temperature equation of state (lower left) and c/a ratio (insert). Angle-dispersive data for H_2 (red points) agree well with previously measured energy-dispersive data (Loubeyre *et al.*, 1996) for H_2 and D_2 (green triangles pointing up and down, respectively). Image of sample at 119 GPa (lower right), the diameter of the sample is $\sim 40 \mu\text{m}$. Measurements were performed at beamline ID09. The Upgrade Programme will improve high-pressure instrumentation for diffraction, scattering and spectroscopic experiments. These enhancements will be of benefit, not only to the study of hydrogen, but also to other molecular solids.

Phonon dispersion and instabilities at high pressures by inelastic X-ray scattering (section 1.4.3) also raise other essential questions. The study of the electronic band gap of hydrogen is also important for understanding mechanisms of metallisation. The band gap decreases with increasing pressure. As it is larger than that of diamond, it can be estimated only indirectly over a great pressure range. X-ray Raman scattering (chapter 1.4) can provide direct access to the hydrogen absorption edge including evidence for eventual electronic changes.

The Upgrade Programme will result in improved instruments for diffraction, spectroscopic and scattering studies. These will not only help to solve the numerous unanswered questions in the behaviour of hydrogen under extreme conditions, but will also be very valuable for the investigation of other recently discovered or to be discovered physical phenomena at high pressures. These include dissociation and "polymerisation" in other molecular solids, the occurrence of incommensurately-modulated structures in elemental solids, the relationship between structural symmetry breaking and complex metallic behaviour in simple metals, the interplay between structural, electronic and magnetic interactions in rare-earth and transition-metal compounds, the role of structure in macroscopic quantum effects like superconductivity, the relationship between crystal structure and electronic properties in low-dimensional organic conductors, the mechanisms of structural phase transitions, disorder in crystalline solids and transitions in nanocrystalline, disordered or liquid materials and many others.

Planetary science and the interior of the Earth

The study of the Earth requires a multi-disciplinary approach to investigate its many varied dynamic processes. These may be driven by changes in density, electronic and magnetic behaviour, of redox potential, or through structural modifications in major mineral compositions. Subtle phenomena can have global consequences. To investigate and understand complex systems such as the Jovian planets, with their immense inner structure based on a fluid mix of metallic hydrogen and helium, it would be interesting to extend the parameters currently attainable to include such crushing pressures.

On Jupiter, the atmosphere is a dense supercritical fluid. This is a phenomenon which occurs at high pressure and temperature where there is no difference between gas and liquid (Figure 1.3.9) and therefore no sharp demarcation akin to that between Earth's atmosphere, land and water mass. Jupiter and Earth have a magnetic field; the prerequisites for this is a rotating fluid layer that is electrically conducting with high heat-flow. On Jupiter, this comes from a fluid

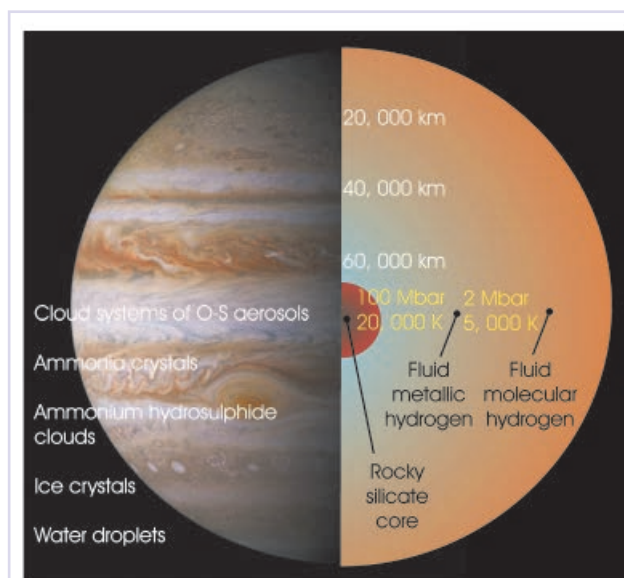

Figure 1.3.9: Schematic illustration of the structure of Jupiter.

The pressure and temperature ranges are much larger compared to Earth. Jovian systems are also based on light elements with the major component being hydrogen, which exists as a liquid and as a dense, supercritical fluid form. At around 25,000 km depth, hydrogen also becomes metallic, giving rise to the enormous magnetic field on Jupiter.

mixture of helium and metallic hydrogen and on Earth from iron sulphide-based liquids. The most direct evidence of the internal structure of the Earth comes from observing travel times of earthquake-generated compression (P) and shear (S) waves through the Earth. These data can be inverted to estimate the bulk density of the minerals that the waves travel through at depth, the presence of the liquid outer core (S-waves do not travel in liquids whereas P-waves do) and distinct strata within the Earth. Each of these is visible due to a rapid modification of the crystal structure of the dominant minerals at depth (Oganov and Ono, 2004). To investigate or model the structure of planetary interiors, precise information on these very crystal, liquid and fluid structures and how they respond to loading and heating is required. This is achieved through simulation of real planetary conditions in the laboratory.

Advancing technology has enabled investigations of mineral properties at pressures approaching those at the centre of the Earth, ~3.5 Mbar. This technology is not widespread as most investigations are limited to between one-third and one-half of this pressure range. In addition, deeper inside the Earth, not only does the pressure increase, but heat released from various processes serves to increase the temperature, so that, at the centre of the Earth, the temperature exceeds 6000 K. It is technically possible to attain such pressures but it has never been proven that, for example, the structure of minerals at these extreme

pressures and temperatures can be observed and their densities measured. It is less probable again that any of the electronic or magnetic properties of minerals under these conditions can be investigated. It is, however, critically at these depths where the intimate balance between electronic, magnetic, rheological and the physical properties of minerals, that gives rise to the most fundamental Earth and planetary processes, can be observed (for example, the source and function of the magnetic field and the speed of the planet's rotation).

Beamline ID27 represents a considerable step towards realising these experimental and technical feats (Mezouar *et al.*, 2005) yet considerable upgrades in both the source and detector technology are required to realise its full potential in unravelling the structures and internal processes of the Earth and other planets. This is especially true when structural transitions are often concomitant, or are caused by changes in electronic structure or spin-state, which are not resolved by diffraction alone. The simultaneous use of complementary techniques (Raman, absorption, emission and inelastic spectroscopies, for example) is therefore at the forefront of geophysical measurements at extreme conditions and still requires improvements of the source, as well as the experimental developments proposed in the Upgrade Programme to succeed (see [chapter 2.4](#)).

Static diffraction measurements are important for the measurement of structure and observation of the variation in density with pressure and temperature but do not provide all of the information needed in this context. Coupled experiments that measure dynamic responses to loading and heating give more insight into the mechanics of Earth processes. Dynamic techniques cover a wide range of timescales, from mechanical deformation and creep studies with very long periods through acoustic and optical

measurements, like Brillouin light scattering, to THz inelastic scattering. Indeed, some experiments have made use of related techniques to establish elastic properties, evidence spin transitions and other phenomena in Earth-forming minerals under extreme conditions (Badro *et al.*, 2004).

Inelastic X-ray scattering (IXS) makes it possible to determine P-wave velocities directly, and can be constrained in combination with nuclear inelastic scattering (NIS) and X-ray diffraction S-wave velocities (Antonangeli *et al.*, 2004). Furthermore, the determination of the phonon-density of states and the analysis of the dynamic structure give access to a host of thermodynamic properties, which cannot be obtained by any other experimental technique (Mao *et al.*, 2001). X-ray fluorescence is sensitive to the spin-state and has been utilised to evidence spin transitions and changes in the electronic structure in Earth-forming minerals under extreme conditions (Badro *et al.*, 2004).

X-ray absorption fine structure maps of redox and speciation under extreme conditions of pressure and temperature yield information on possible phase transitions and/or chemical reactions occurring in the interior of planets. A major component of the Earth's mantle, ringwoodite (γ -(Mg,Fe)₂SiO₄) is thought to undergo chemical decomposition at around 660 km depth (approximately 23 GPa) and 1600°C, corresponding to a strong seismic discontinuity, to form (Mg,Fe)SiO₃-perovskite and (Mg,Fe)O-magnesiowustite. [Figure 1.3.10](#) illustrates Fe K-edge XANES maps of normalised absorbance at a defined energy at 26 GPa before (left) and after (right) laser heating. Analysis of the modifications in the spectra from the hot spot region allow iron speciation at high pressure and temperature to be extracted, yielding key information for the modelling of the Earth's mantle processes.

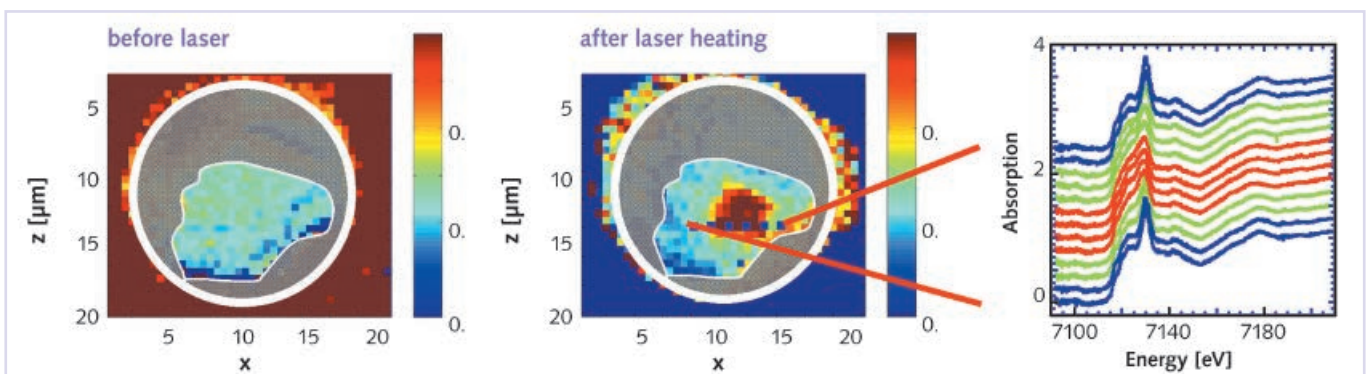

Figure 1.3.10: X-ray near-edge absorption spectra of (Mg,Fe)SiO₃ perovskites under high pressure before and after annealing.

Similar information has been obtained in combined NFS (nuclear forward scattering) and XRD measurements at pressures beyond 100 GPa and temperatures exceeding 1000 K, resulting in the discovery of a new component, which stabilises at high pressures (work carried out in collaboration with L. Dubrovinsky, Bayerisches Geoinstitut, Universität Bayreuth, Germany).

The Upgrade will enhance studies on these types of material under extremes conditions with improved X-ray source and detector characteristics combined with multi-disciplinary and simultaneous measurements from the same sample and even with *in situ* chemistry.

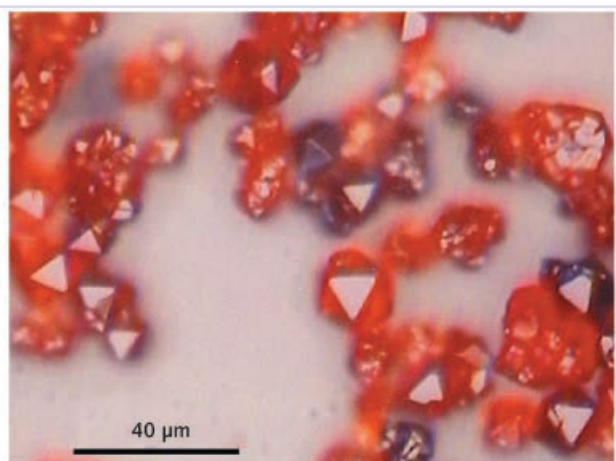

Figure 1.3.11: B_6O icosahedral crystals synthesised at high pressure and high temperature (Hubert *et al.*, 1998). Materials science will benefit from the ability to follow the chemical synthesis of novel materials *in situ* using synchrotron radiation.

The development of a multi-anvil device at the ESRF will also improve our capabilities in this important area, whereby coupling of ultrasonic interferometry with X-ray diffraction results in a completely self-sufficient experiment capable of measuring all of the necessary thermodynamic information required for modelling the Earth's interior via combined dynamic and static X-ray diffraction methods. These methods can be applied elsewhere, for example to establish primary pressure scales as a function of temperature. The proposed multi-anvil device will be very versatile and be able to control temperature and pressure gradients and control redox potentials; that is, to perform real chemistry in a controlled system. The ability to study reactions, site-ordering and the effect of cation occupancies on mineral stability will be vastly improved, as will the ability to control hydrostaticity and vary stress conditions and so measure rheological properties under high pressure and temperature. Another subject area that will be offered is the study of liquids. Of interest will be their structures, melting curves, viscosities, densities and any phenomena associated with melting or equilibrium chemistries, elastic softening, partial melting and immiscibility, together with properties such as electronic conductivity.

The Upgrade Programme puts the future of the study of geological systems at the ESRF on to a sure footing. The outlook is bright: recent developments demonstrate the ability to develop new techniques that offer further experimental avenues to aid our understanding of Earth processes. Nonetheless, in order to harness the full potential of the proposed experimental programme, upgrades are required in terms of capacity, the source, optical components and detector developments, in addition to technical advances in sample environment.

Novel materials synthesis and characterisation

High pressure is an important thermodynamic variable in addition to being a cause of modifications of a material's electronic structure and its crystal packing, resulting in polymorphism. It ranks alongside temperature and chemical potential for determining and causing changes in the states of matter and driving chemical reactions. One of the classical uses of high pressure in materials synthesis is the search for new materials in the BCNO composition pyramid because of their potential industrial applications. Crystals of B_6O with remarkable icosahedral symmetry (Hubert *et al.*, 1998), obtained from the solid-state reaction of boron and oxygen at pressures around 4 GPa and temperatures exceeding 1300 K, are shown as an example in Figure 1.3.11.

Recent improvements in diamond cells and large volume design coupled to resistive and laser heating at the high flux beamlines ID30/ID27 have permitted the *in situ* monitoring of the course of synthesis of super-hard materials with hardness values comparable to diamond or cubic boron nitride. For instance, a new super-hard compound c- BC_2N with Vickers hardness $H_v = 76$ GPa has been synthesised and characterised *in situ* in the double-sided laser-heated diamond-anvil cell at beamlines ID30/ID27 (Solozhenko *et al.*, 2001). The *in situ* sequence of formation is presented in Figure 1.3.12. This new material replaces c-BN as the second hardest pure phase and has a better thermal stability than diamond, a property that is essential for machining hard metals at high speed. Another very important example of solid-state chemistry at high pressure is the *in situ* synthesis of high T_c oxide superconductors such as $HgBa_2CaCuO_{8+\delta}$ achieved in the Paris-Edinburgh press available at the high-pressure beamlines.

The precise control over the stoichiometry to achieve the highest T_c values is a very important parameter that is easy to monitor in large volume presses. The highest T_c recorded so far (133 K) was obtained for $HgBa_2CaCuO_{8+\delta}$ (Hg-1234) at ambient pressure: this value was further increased to a record breaking $T_c = 164$ K at 30 GPa. The *in situ* XRD method makes it possible to achieve fine control of the kinetics of formation of all of the intermediate phases and fine tuning of the crystal growth of the phase of interest.

The new high-pressure beamlines planned within the Upgrade Programme will offer a new panel of techniques that will give a new dimension to the *in situ* high-pressure chemistry programme. Indeed, the search for very hard materials is coupled to the study of low-compressibility solids, which have high values of the bulk modulus K_T and the shear modulus G . The precise determination of K_T requires *in situ* XRD study in the megabar regime and therefore requires the ultimate performance of the high-pressure beamline

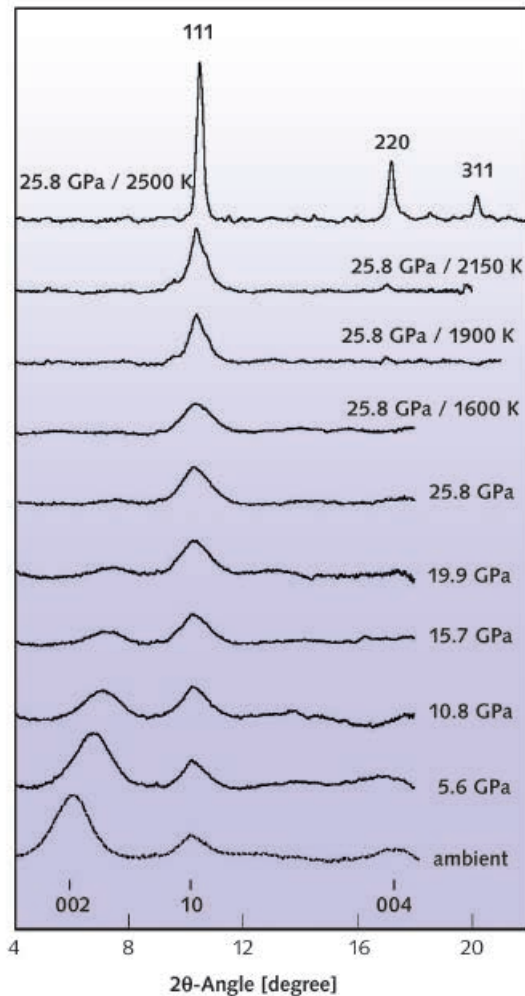

Figure 1.3.12: The sequence of X-ray diffraction patterns obtained during the formation of the super-hard cubic BC₂N from graphite-BC₂N. The synthesis was performed *in situ* on beamline ID30 using laser heating at high pressure (Solozhenko *et al.*, 2001), image courtesy of V.L. Solozhenko. The Upgrade Programme will offer a new pool of techniques for the *in situ* study of materials synthesis.

ID27 in terms of photon flux and X-ray beam size. These improved performances will also be a key factor for observing the kinetics of fast chemical reactions. The installation of a large multi-anvil press, with its inherently large, controllable sample environment will naturally address questions related to the optimisation of bulk synthesis. The use of associated techniques means that it can also be used for measurement of shear modulus, Young's modulus and other mechanical properties.

Electronic structure and magnetism influenced by high pressure

Correlated electron systems (which are dealt with in detail in chapter 1.4 but are also included here to highlight the link with high-pressure experimental

environments for studying structure and material properties) show a rich variety of behaviour, which is due to an interplay and competition between spin, orbit, and charge order. Pressure, in addition to temperature, electric and magnetic fields, is one parameter that may crucially influence those properties. The difficulty lies in combining the sample environment requirements of high pressure, low temperature and external electric and magnetic fields with the various X-ray techniques available at synchrotron radiation sources to study the structure, dynamics, and electric and magnetic properties of these materials.

The "Kondo insulator" material SmS does not, for example, order magnetically at ambient pressure. Theory predicts, however, that a semiconducting, magnetically-ordered state can be induced at high pressure and low temperature. Multiple X-ray techniques were applied in a coordinated effort to elucidate this state: the structural and electronic properties were studied via (resonant) magnetic scattering (Deen *et al.*, 2005), the dynamics via inelastic X-ray scattering (IXS) (Raymond *et al.*, 2002), the valence via resonant inelastic X-ray scattering (RIXS) (Annese *et al.*, 2006), and the appearance of a magnetic ground state as well as short range magnetic correlations in the semiconductor phase via nuclear resonance scattering (NRS) (Barla *et al.*, 2004). Pressure was the important common parameter. Figure 1.3.13 shows the proposed phase diagram resulting from the measurements in all of these investigations.

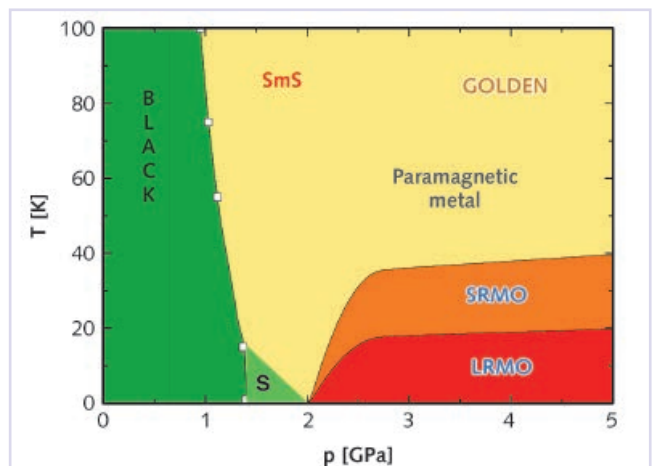

Figure 1.3.13: Upon the application of hydrostatic pressure, SmS transforms from a "black" Kondo insulator to a "golden" paramagnetic metal (Barla *et al.*, 2005). Cooling in the metallic phase induces first short range (SRMO), and, then, towards lower temperatures, long range magnetic order (LRMO), with a small semiconducting pocket (S) at lowest temperatures and intermediate pressures. Various techniques available at the ESRF contributed to this diagram. The Upgrade Programme aims to foster this holistic approach in order to decipher a complete picture of the system.

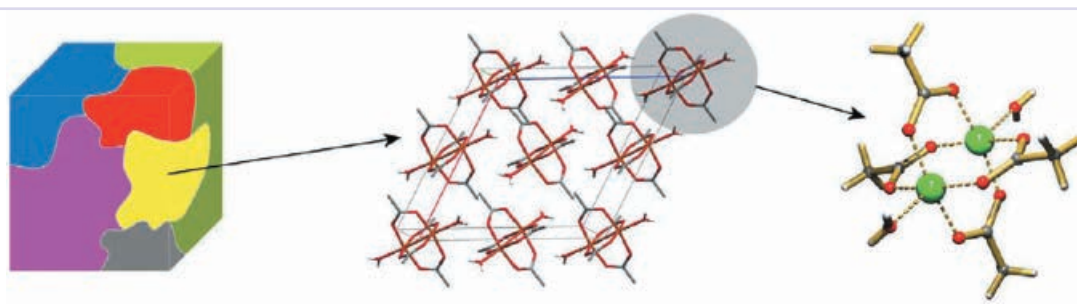

Figure 1.3.14: Characterisation of a sample on several length scales: from the distribution of grains (left) to the crystal and molecular structures via 3DXRD.

The Upgrade Programme will open a much larger parameter space (pressure, temperature, magnetic field) to various X-ray techniques, with the aim of investigating several aspects of the sample simultaneously, under the same conditions. The projects for *in situ* laser heating (5000 K) and high static (40 T) and pulsed (60 T) magnetic fields (see sections 2.4.2 and 2.4.5) are of particular interest.

Relevant Conceptual Design Reports:

- EDXAS-S: Energy Dispersive Absorption Spectroscopy (small spot)
- HIPRE: High Pressure Technique Beamlines
- INELX: Inelastic X-ray Scattering
- NR-HE: Nuclear Resonance - High Energy
- PHIXS: Phonon Inelastic X-ray Spectroscopy
- XAS-XES: Steady-State and Time-Resolved X-ray Absorption and Emission Spectroscopy

Key enabling technologies and infrastructures:

- Detectors: large area, high spatial and temporal resolution, high uniformity and low noise, high dynamic range, high energy, energy discrimination.

The overall objective of the materials science beamlines is to provide a resource that covers length scales from angstroms to micrometres to millimetres and timescales from sub-milliseconds to hours or weeks. Imaging and diffraction using high-energy X-rays are central to this aim and will be improved with the availability of cryogenic undulators, higher stored current in the ring and enhanced high-energy detectors. Surface diffraction/scattering from ordered nano-scale objects combined with atomic-force microscopy to identify regions of interest and to serve as a guide for the X-ray experiments is foreseen to obtain important physical information such as stress fields. On a larger scale, the characterisation of (often bulky) engineering components is crucial to both academia and industry. High intensity, penetrating hard X-rays together with suitable sample environments (*e.g.* stress rigs) are required to analyse these materials. The Upgrade will allow processes, such as crack propagation, nucleation and microstructure development during solidification, and temperature/pressure variation, to be followed *in situ* and in real time using non-invasive, high-energy X-rays.

1.3.5. Materials science

Materials science is the study of all of the materials useful to mankind, from soft organic materials to metals, inorganics and intermetallics. The aim of materials science is to study real working components, often under operating conditions, and a wide array of techniques is necessary to characterise fully the samples of interest. Functionality is intricately related to and often determined by the sub-micrometre structural characteristics of materials. Furthermore, important solid-state phenomena take place on the sub-second timescale. The Upgrade aims to extend X-ray based methods into these domains. The majority of real materials are at least moderately absorbing, and it is generally necessary to use high-energy X-rays to study them. The ESRF is and will remain almost uniquely placed as a high-energy X-ray source: its present and projected future capabilities in high-energy focusing are world leading. Continued development within the Upgrade Programme will consolidate its stature as the world's leading synchrotron facility for materials science.

Full hierarchical characterisation of materials

Most materials occurring in nature such as rocks, ice and soil appear as complex heterogeneous and hierarchical aggregates of crystallites, domains and dislocation structures. Man-made materials, from synthetic products to engineering materials, are also usually polycrystalline and inhomogeneous, as are drugs and trace particles relevant to environmental matters and objects of artistic or archaeological significance. Materials science is a field in which, where possible, "the experiment is brought to the sample" rather than the reverse. The goal is therefore to obtain high-quality crystallographic and microstructural data on even these defective samples. Ultimately, the aim is to perform total simultaneous hierarchical characterisation (Figure 1.3.14) of arbitrary samples. To this end, we have developed an array of new diffraction-based methods utilising high-energy microfocusing and collectively referred to as three-dimensional X-ray diffraction (3DXRD) microscopy, to characterise polycrystalline samples over several length scales, from the angstrom scale (crystal structure) to

the grain distribution over the entire sample (see Juul Jensen *et al.*, 2006, for a recent review).

The interest in total hierarchical characterisation has led to the development of new methods aimed at the study of polycrystalline samples over several length scales, from the atomic scale (angstrom-level crystal structures, see section 1.3.2) to the grain distribution over the entire sample (millimetres). The sub-micrometre range (discussed in chapter 1.1) is of particular interest in materials science as it is the critical length scale for many intergranular interactions such as dislocations and cracks, as well as being important for interfaces and surface layers. It is these interactions that ultimately give rise to the bulk properties of continuous materials. The lack of detailed knowledge of the distributional heterogeneity of properties on this scale has resulted in the inability to construct rigorous first-principles models of such basic materials properties such as strength, fatigue resistance, and texture development. The weakness of the present models for these processes arises from the lack of appropriate experimental data on the length scale of interest. This lack of data is due in a large part to the limitations of the methods available to analyse the structure of the samples appropriate to studying such phenomena. Bulk information may be collected by powder diffraction, but such data represent an ensemble average over the sample grains, and is uninformative on sample inhomogeneity, intergranular interactions and the form of distributions of properties. Data from electron microscopy (diffraction or imaging) are of very high spatial and angular resolution, and may be used to study intergranular interactions and, somewhat tediously, may be used to build up grain statistics. However, this technique is limited to surfaces only, and is not generally amenable to *in situ* experiments. X-ray tomography is another tool for studying sample microstructure, although the nature of the image data is different, and very complementary, to diffraction data.

Technical developments related to the Upgrade Programme, in particular the further development of high-energy nanofocusing and the accompanying advances in sample metrology and beam and sample positioning, will allow our methods to be applied to much shorter length scales than are currently feasible. In particular, the sub-micrometre length scale will be accessed. We will thus be able to characterise the structure and microstructure of essentially any crystalline material on multiple length scales.

X-ray imaging and diffraction techniques in materials science

Engineering materials science focuses on the characterisation and understanding of thermo-mechanical processes in structural materials. These processes are governed by different length and timescales which cover several orders of magnitude. The aim of experimental techniques is to establish a 3D spatially-resolved distribution of physical parameters describing the material properties on variable timescales down to the sub-second regime. The following selected examples highlight possible materials science research areas, which would benefit from an improved time and spatial resolution of diffraction and imaging techniques described in chapters 2.2 and 2.5.

It is impossible to attempt to predict crack shape evolution in the framework of linear elastic fracture mechanics without taking into account the actual grain microstructure (see Figure 1.3.15; Buffière *et al.*, 2006). Issues like how the stress state evolves during cyclic loading around cracks can be studied by combining fast X-ray tomography, and the depth-resolved diffraction technique, described later in this chapter.

Figure 1.3.15: Three-dimensional rendering of a microtomographic image of a crack (left), and of the same crack and the grain structure (right), showing the interaction of fatigue crack propagation with inhomogeneities (grain boundaries, porosities) in a cast aluminium alloy. The developing technique of fast tomography at high energies (requiring detectors with improved sensitivity from the Upgrade) will greatly improve the study of the evolution of cracks in materials.

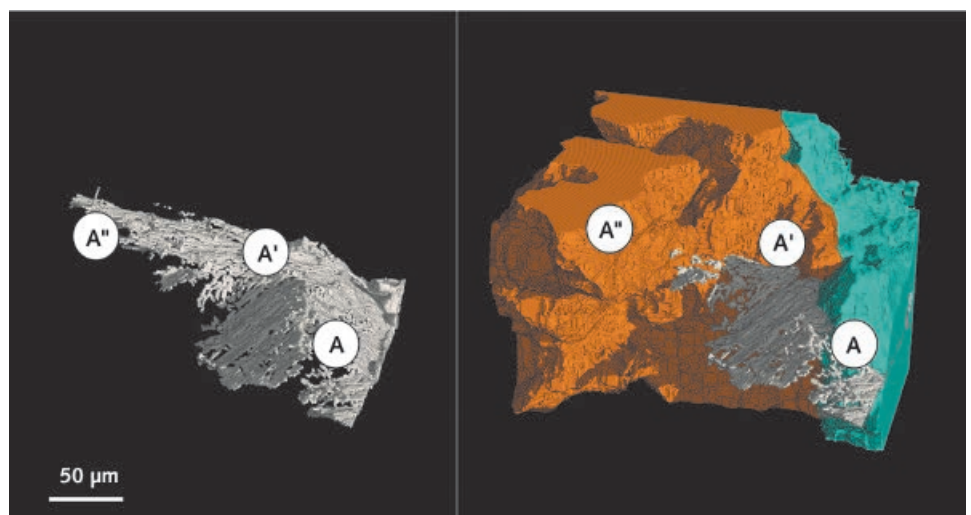

Reprinted with permission from Buffière J.Y., Ferré E., Proudhon H., Ludwig W., *Materials Science and Technology* 22(9), 1019-1024 (2006), copyright 2006 Maney Publishing.

Further developments of microtomographic imaging resolution, described in section 2.2.2, to the few tens of nanometres scale will have an enormous impact on materials science. A good example of this can be found in studies on liquid-metal embrittlement. It was unclear whether the formation of microscopic grain boundary wetting layers involves grain displacements and plastic deformation of the grains, or if it proceeds by diffusion and dissolution-like processes. The simultaneous observation of grain displacements and liquid layer thickness by means of *in situ* X-ray projection microscopy experiments, using a state-of-the-art spot size of $90 \times 90 \text{ nm}^2$, gave clear evidence for the first scenario (see Figure 1.3.16; Pereiro-Lopez *et al.*, 2005).

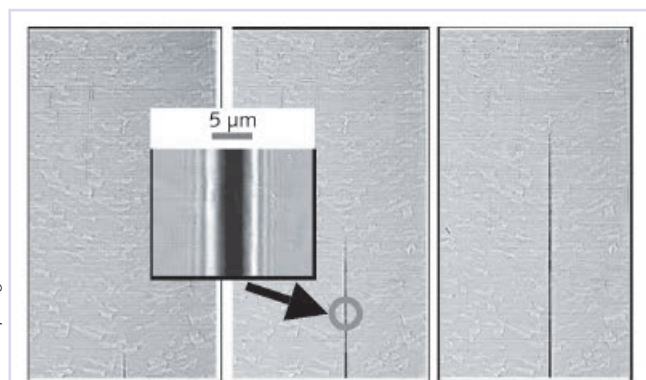

Figure 1.3.16: Penetration of liquid gallium in aluminium observed by projection microscopy with a virtual X-ray source of $90 \times 90 \text{ nm}^2$. Improvements in spot size and detectors will enhance the spatial resolution and sensitivity of microtomographic imaging – especially at the high energies required for materials science.

A second example is looking at phase evolution in casting which is determined by the timescale of the solidification process. The environment of casting means that it is difficult to observe directly the formation of stray grains, the effect of nucleating agents or the precipitation of terminal eutectic phases, all of which have consequent effects on the properties of the solidifying mush and the production of porosity, etc. Time-resolved tomography and diffraction (CDR: HIENE) provide information of great importance for solidification modelling, *e.g.* in automotive components and aero-engine turbine blades.

Surface X-ray diffraction/scattering coupled with AFM

The development of reliable nanotechnologies depends on the ability to direct the organisation of a large number of nanoscale objects into ordered structures of macroscopic size (micrometres to millimetres), in a predictable and reproducible fashion. The individual building blocks have sizes

in the range 1 to $\sim 1000 \text{ nm}$. They are made of amorphous or crystalline nanoparticles and they are typically coated by a layer of stabilising molecules. The core nanoparticle can be metallic, semi-conducting, insulating, magnetic, etc. It is expected that proper mixtures of different types of nano-objects will yield the most interesting smart nanomaterials of the future.

The superstructures formed can vary from simple short-range-ordered monolayers, to 2D arrays and multi-layers, to extended 3D superlattices that mimic the structure of conventional atomic solids. Typically, these superstructures will be formed at solid surfaces or buried interfaces by spontaneous or directed self-assembly from liquid solutions. These phenomena are already the object of intense research efforts (Bigioni *et al.*, 2006; Leunissen *et al.*, 2005; Shevchenko *et al.*, 2006). The detailed mechanisms of order formation are still, however, only partially understood. In particular, the role played by liquids at the nanoscale in super-order formation/transformation has just begun to be investigated (Alvine *et al.*, 2006).

Studies in this context have the double advantage that they can be tailored to investigate fundamental scientific issues, whilst being, at the same time, potentially prone to direct nano-technological applications. Examples of such studies are the search for (a) reversible structural transitions in nanoparticle superlattices, (b) size segregation phenomena in 2D or 3D nano-confinement, (c) Casimir-type inter-particle forces induced by fluctuations in critical binary solvent mixtures.

The Upgrade Programme developments of high-energy X-ray diffraction/scattering from surfaces and buried interfaces will play an important role over the next decade, enabling *in situ* and real-time probing of the superstructures being formed or transformed during nanoscale solvent evaporation or adsorption. Moreover, the combination of a high-energy surface microdiffraction apparatus with an atomic-force microscope (described in the CDR HIENE) will make it possible to measure simultaneously the average superstructure (X-ray data) and local defects in the nanoparticle arrangement (AFM data). Finally, the development of special 2D detectors, described in chapter 2.5, will allow high-energy SAXS/GISAXS experiments to take place yielding information about the long-range order of buried nanoparticle superlattices.

Characterisation of engineering components

The Upgrade Programme will create new opportunities for the characterisation of materials. Until now, this type of work has been performed on a variety of beamlines that are not optimised for

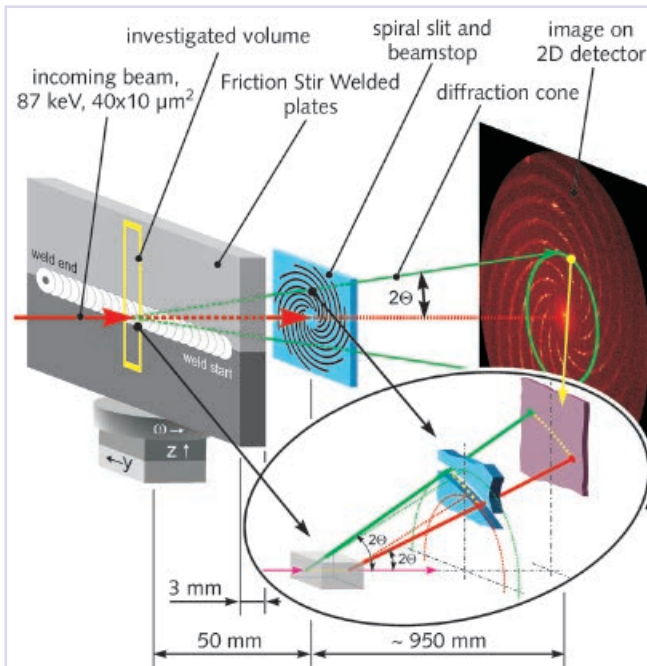
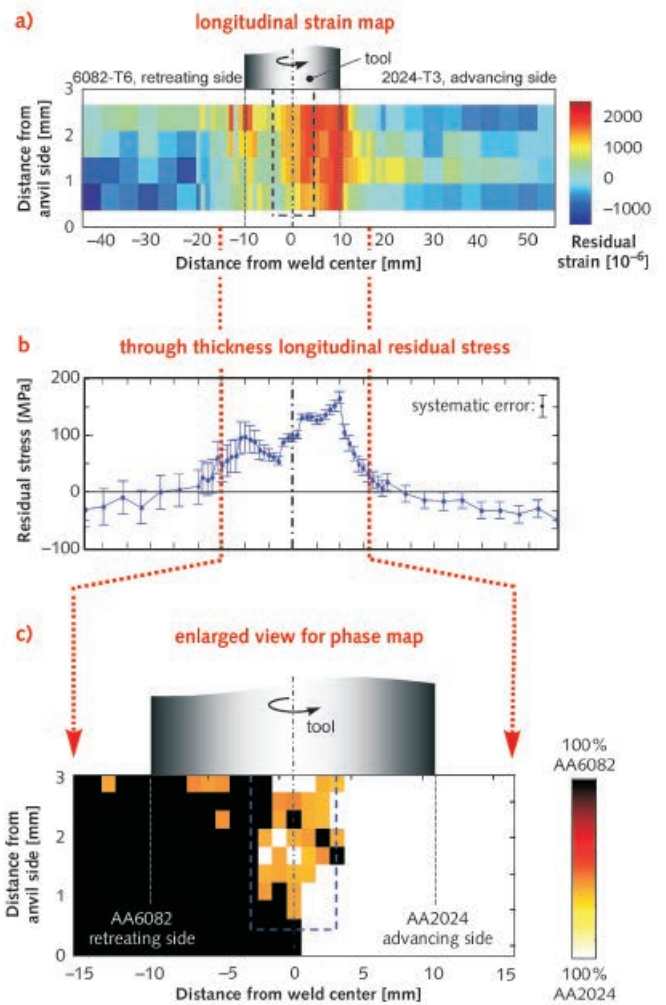

Figure 1.3.17: a) The experimental setup with spiral slits at ID15B; b) Depth-resolved residual macro strain in the longitudinal direction (parallel to the weld); c) Through thickness longitudinally-resolved stress components, calculated from strain measurements in three dimensions; d) Enlarged view of the distribution of the plate material (AA6082 and AA2024) in the stirring region (Martins and Honkimäki, 2003). The Upgrade will extend studies such as these to larger samples with shorter data recording times (allowing time resolution of rapid phenomena) and higher spatial resolution.



industrial applications. This results in long set-up times and problems in creating identical conditions for measurements over extended time periods.

The improvements will allow fast measurements, the aim being for sub-second resolution for bulk samples even with high atomic weight components and for stress/strain bulk measurements. Investigation of deactivation of catalysts, batteries, fuel cells, etc., will also be carried out. In these studies, the X-rays have to penetrate the reaction vessels needed to mimic actual operating procedures. These processes often work on the second timescale and, thus, the sub-second resolution, currently not possible, is required to observe the phenomena that develop in real time as intermediate phases and reactions, which are often essential for formulation of appropriate models. Other areas of acute urgency are studies of crack propagation, nucleation and microstructure development during solidification of alloys, for example, and of aluminium, which is of interest to the large European aluminium foundry industry. An example of results that can be obtained today is shown in Figure 1.3.17. Bulk investigation of 3 mm thick dissimilar aluminium plates fused by friction stir-welding yielded information on resulting residual

strain and silicon particle migration. The Upgrade Programme will allow these studies to be extended to larger samples and much shorter timescales (sub-second) than now (minutes). The Upgrade will allow beam sizes to be much smaller than they are currently due to the novel optics and vibration-control engineering foreseen in the programme.

For many engineering projects, access to hard, highly-penetrating X-rays is essential in order to perform non-invasive bulk measurements of large-dimension samples. The Upgrade Programme will provide new sources of hard X-rays by implementing cryogenic undulators in longer 7 m straight sections, with the added benefit of higher ring currents resulting in unprecedented X-ray fluxes in the 50 to 150 keV range. The proposed development of high-energy sensors for detectors described in chapter 2.5 will allow efficient use of these X-rays with an overall improvement in measuring conditions of many orders of magnitude (10^2 to 10^3).

It is of utmost importance to be able to understand the property evolution of materials under varying conditions such as stress, temperature, pressure, and the effect of circulating fluids. These studies require

stress rigs and environmental chambers which are often bulky and heavy. Their results are important both in terms of direct process control, as well as for providing input and validation of theoretical models of the processes. The Upgrade Programme will provide vastly expanded possibilities in these areas. For these types of studies, it is necessary to have a fixed setup in the experimental hutches with the possibility of continuing experiments for several weeks whilst performing a synchrotron experiment only once in a while (*e.g.* for one hour every day) under identical conditions. High levels of automation will be needed to provide efficient throughput and a rapid change of samples. A specialised hutch will be needed to allow handling of bulky environments and large samples such as landing gear, etc. (several tons can be envisioned). An example of a possible dedicated beamline is briefly outlined in the CDR EMS, though other CDRs are directly relevant (*e.g.* HIENE, MATSCI, which are also listed in the table at the end of this section). The critical developments are time resolution, new high-energy detectors, new low-temperature undulators and environmental control of all beamline components.

Relevant Conceptual Design Reports:

- EMS: Engineering Materials Science
- HIENE: High Energy X-ray Beamline
- HIPRE: High Pressure Technique Beamlines
- MATSCI: Materials Science
- POW: High Resolution Powder Diffraction
- TRD: Time-Resolved Diffraction and Pump-and-Probe

Key enabling technologies and infrastructures:

- Detector development (high energy, pixel detectors) all beamlines
- Cryogenic undulators for HIENE, MATSCI, POW
- Engineering for nanofocusing (vibrations, beam feedback, control software) for MATSCI, HIENE
- Integration and preparation laboratories

References

- Alvine K.J., Pontoni D., Shpyrko O.G., Pershan P.S., Cookson D.J., Shin K., Russell M., Brunnbauer T.P., Stellacci F., and Gang O. (2006), Solvent mediated assembly of nanoparticles confined in mesoporous alumina, *Phys. Rev.*, **B 73**, 125412.
- Annese E., Barla A., Dallera C., Lapertot G., Sanchez J.-P., and Vankó G. (2006), Divalent-to-trivalent transition of Sm in SmS: Implications for the high-pressure magnetically ordered state, *Phys. Rev.*, **B 73**, 140409(R).
- Antonangeli D., Occelli F., Requardt H., Badro J., Fiquet G., and Krisch M. (2004), Anisotropy in textured hcp-iron to 112 gigapascals from sound wave propagation measurements, *Earth Planet. Sci. Lett.*, **225**, 243.
- Badro J., Rueff J.P., Vankó G., Monaco G., Fiquet G., and Guyot F. (2004), Electronic transitions in perovskite:

Possible nonconvecting layers in the lower mantle, *Science*, **305**, 383-386.

- Barboiu M., Vaughan G., Graff R., and Lehn J.M. (2003), Self-assembly, structure, and dynamic interconversion of metallocsupramolecular architectures generated by Pb(II) binding-induced unfolding of a helical ligand, *J. Am. Chem. Soc.*, **125**, 10257-10265.
- Barla A., Sanchez J.P., Haga Y., Lapertot G., Doyle B.P., Leupold O., Rüffer R., Abd-Elmeguid M.M., Lengsdorf R., and Flouquet J. (2004), Pressure-induced magnetic order in golden SmS, *Phys. Rev. Lett.*, **92**, 066401.
- Barla A., Derr J., Sanchez J.P., Salce B., Lapertot G., Doyle B.P., Rüffer R., Lengsdorf R., Abd-Elmeguid M.M., and Flouquet J. (2005), The Unusual Magnetic Properties of Samarium and its Compounds, *ESRF Highlights*, 9-10.
- Bigioni T.P., Lin X.M., Nguyen T.T., Corwin E.I., Witten T.A., and Jaeger H.M. (2006), Kinetically driven self assembly of highly ordered nanoparticle monolayers, *Nat. Mater.*, **5**, 265.
- Billinge S.J.L. and Kanatzidis M.G. (2004), Beyond crystallography: the study of disorder, nanocrystallinity and crystallographically challenged materials, *Chem. Commun.*, **7**, 749-760.
- Buffière J.Y., Ferrié E., Proudhon H., and Ludwig W. (2006), 3D visualization of fatigue cracks in metals using high resolution synchrotron microtomography, *Mater. Sci. Technol.*, **22**, 1019-1024.
- Deen P.P., Braithwaite D., Kernavanois N., Paolasini L., Raymond S., Barla A., Lapertot G., and Sanchez J.P. (2005), Structural and electronic transitions in the low-temperature, high-pressure phase of SmS, *Phys. Rev.*, **B 71**, 245118.
- Férey G., Mellot-Draznieks C., Serre C., Millange F., Dutour J., Surblé S., and Margiolaki I. (2005), A chromium terephthalate-based solid with unusually large pore volumes and surface area, *Science*, **309**, 2040-2042.
- Glatzel P. and Bergmann U. (2005), High resolution 1s core hole x-ray spectroscopy in 3d transition metal complexes – Electronic and structural information, *Coord. Chem. Rev.*, **249**, 65-95.
- Glatzel P., Bergmann U., Yano J., Visser H., Robblee J.H., Gu W., de Groot F.M.F., Christou G., Pecoraro V.L., Cramer S.P., and Yachandra V.K. (2005), The electronic structure of Mn in oxides, coordination complexes and the oxygen-evolving complex of photosystem II studied by resonant inelastic X-ray scattering, *J. Am. Chem. Soc.*, **126** (32): 9946-9959.
- Haumann M., Liebisch P., Müller C., Barra M., Grabolle M., and Dau H. (2005), Photosynthetic O₂ formation tracked by time-resolved X-ray experiments, *Science*, **310**, 1019-1021.
- Hubert H., Devouard B., Garvie L.A.J., O'Keefe M., Buseck P.R., Petuskey W.T., and McMillan P.F. (1998), Icosahedral packing of B₁₂ icosahedra in boron suboxide (B₆O), *Nature*, **391**, 376-378.
- Juul Jensen D., Lauridsen E.M., Marguelis L., Poulsen H.F., Schmidt S., Sørensen H.O., and Vaughan G. (2006), X-ray microscopy in four dimensions, *Mater. Today*, **9**, 8-25.
- Leunissen M.E., Christova C.G., Hynninen A.P., Royall C.P., Campbell A.I., Imhof A., Dijkstra M., van Roij

- R., and van Blaaderen A. (2005), Ionic colloidal crystals of oppositely charged particles, *Nature*, **437**, 235-240.
- Loubeyre P., Le Toullec R., Häusermann D., Hanfland M., Hemley R.J., Mao H.K., and Finger L.W. (1996), X-ray diffraction and equation of state of hydrogen at megabar pressures, *Nature*, **383**, 702-704.
 - Mao H.K. and Hemley R.J. (1994), Ultra high-pressure transitions in solid hydrogen, *Rev. Mod. Phys.*, **66**, 671-692.
 - Mao H.K., Xu J., Struzhkin V.V., Shu J., Hemley R.J., Sturhahan W., Hu M.Y., Alp E.E., Vocadlo L., Alfè D., Price G.D., Gillan M.J., Schwoerer-Böhning M., Häusermann D., Eng P., Shen G., Giefers H., Lübbers R., and Wortmann G. (2001), Phonon density of states of iron up to 153 gigapascals, *Science*, **292**, 914.
 - Martin M.M., Plaza P., Meyer Y., Badaoui F., Bourson J., Lefèvre J.-P., and Valeur B. (1996), Steady-state and picosecond spectroscopy of Li⁺ or Ca²⁺ complexes with a crowned merocyanine: Reversible photorelease of cations, *J. Phys. Chem.*, **100**, 6879-6888.
 - Martins R.V. and Honkimäki V. (2003), Depth-resolved investigation of friction stir weld using a novel strain and phase mapping technique, *ESRF Highlights*, 54-55.
 - Mezouar M., Crichton W.A., Bauchau S., Thurel F., Witsch H., Torrecillas F., Blattmann G., Marion P., Dabin Y., Chavanne J., Hignette O., Morawe C., and Borel C. (2005), Development of a new state-of-the-art beamline optimized for monochromatic single-crystal and powder X-ray diffraction under extreme conditions at the ESRF, *J. Synchrotron Radiat.*, **12**, 659-699.
 - Newton M.A., Belver-Coldeira C., Martínez-Arias A., and Fernández-García, M. (2007), Dynamic *in situ* observation of rapid size and shape change of supported Pd nanoparticles during CO/NO cycling, *Nat. Mater.*, **6**, 528-532.
 - Oganov A. and Ono S. (2004), Theoretical and experimental evidence for a post-perovskite phase of MgSiO₃ in Earth's D-layer, *Nature*, **430**, 445-448.
 - Pereiro-Lopez E., Ludwig W., Bellet D., Cloetens P., and Lemaignan C. (2005), Direct evidence of nanometric invasionlike grain boundary penetration in the Al/Ga system, *Phys. Rev. Lett.*, **95**, 215501.
 - Raymond S., Rueff J.P., D'Astuto M., Braithwaite D., Krisch M., and Flouquet J. (2002), Phonon anomalies at the valence transition of SmS: An inelastic X-ray-scattering study under pressure, *Phys. Rev.*, **B 66**, 220301(R).
 - Schotte F., Soman J., Olson J.S., Wulff M., and Anfinrud P.A. (2004), Picosecond time-resolved X-ray crystallography: probing protein function in real time, *J. Struct. Biol.*, **147/3**, 235-246.
 - Shevchenko E.V., Talapin D.V., Kotov N.A., O'Brien S.O., and Murray C.B. (2006), Structural diversity in binary nanoparticle superlattices, *Nature*, **439**, 55-59.
 - Solozhenko V.L., Andrault D., Fiquet G., Mezouar M., and Rubie D.C. (2001), Synthesis of superhard cubic BC₂N, *Appl. Phys. Lett.*, **78**, 1385-1387.
 - Tezcan F.A., Crane B.R., Winkler J.R., and Gray H.B. (2001), Electron tunnelling in protein crystals, *Proc. Natl. Acad. Sci. USA*, **98** (9), 5002-5006.
 - Van Bokhoven J.A., Louis C., Miller J.T., Tromp O., Safonova V., and Glatzel P. (2006), Activation of oxygen on gold-alumina catalysts: *in situ* high energy-resolution fluorescence and time-resolved X-ray spectroscopy, *Angew. Chem. Int. Ed. Engl.*, **46**, 4651-4654.
 - Williams G.J., Pfeifer M.A., Vartanyants I.A., and Robinson I.K. (2003), Three-dimensional imaging of microstructure in Au nanocrystals, *Phys. Rev. Lett.*, **90**, 175501-175504.
 - Wulff M., Bratos S., Plech A., Vuilleumier R., Mirloup F., Lorenc M., Kong Q., and Ihee H. (2006), Recombination of photo-dissociated iodine: A time-resolved X-ray study, *J. Chem. Phys.*, **124**, 34501-34513.
 - Yachandra V.K., Sauer K., and Klein M.P. (1996), Manganese cluster in photosynthesis: where plants oxidize water to dioxygen, *Chem. Rev.*, **96**(7), 2927-2950.

1.4. Dynamical properties and electronic structure of matter

Science context

A deep understanding of the macroscopic physical, chemical and dynamic properties of matter is only possible with a clear understanding of the complex microscopic phenomena that govern them. X-rays are a highly sensitive and selective probe for studying these properties using powerful synchrotron radiation-based spectroscopy and scattering techniques. These boast a unique combination of time structure, polarisation characteristics and the capability to use nanosized beams to probe samples.

The studies are often carried out at extremes of pressure, temperature and magnetic fields with the aim of extending knowledge as far as possible. The impact of this science is not only to understand Nature at its most fundamental level but also to promote applied research, for example, future information and biomedical technology (nanowires, magnetic nanoparticles, optoelectronics, quantum dots), using knowledge of how material behaves at the nanoscale. In this field, the ESRF-ILL (Institut Laue Langevin) joint theory group will play a fundamental role not only in contributing to the understanding and prediction of novel phenomena, but also in fostering and stimulating a productive scientific environment enhancing the visibility of the ESRF-ILL-EMBL (European Molecular Biology Laboratory) campus.

Added value of the Upgrade

To deepen and broaden the application of spectroscopic and scattering techniques, a set of ambitious projects to vastly improve their performance are planned within the framework of the ESRF Upgrade. These projects are outlined below:

- Extend the investigation of the dynamic, electronic and magnetic properties of materials, including surfaces and nanoscale objects to unprecedented time, spatial and spectral resolutions.
- Enable inelastic X-ray scattering to explore a

space and time domain, which is currently not covered by any other experimental technique and is of critical importance for understanding the atomic dynamics in liquids and disordered systems, and condensed matter in general.

- Extend the energy range of nuclear resonance techniques to access almost all Mössbauer atoms with natural abundance for nuclear resonance techniques. Nickel (bio- and solid-state applications) and germanium (semiconductor research) are two examples that will be added.
- Push the boundaries of magnetic fields applied to samples by developing environments of more than 50 T pulsed and 30 T static fields in order to improve understanding of the interplay between structural, electronic and magnetic degrees of freedom in strongly correlated electron systems.

Key questions

The Upgrade Programme is essential to address many important questions in contemporary science. Amongst these are:

1. How is high-temperature and unconventional superconductivity related to the structural, electronic and magnetic degrees of freedom, and what is the role of the electron–phonon interaction?
2. What are the fundamental limitations in the speed of spintronic and magneto-optic devices and magnetic storage technology?
3. How is the low-temperature universal anomaly in the specific heat and thermal conductivity of glasses related to sound propagation and damping?
4. How are the dynamic properties altered at surfaces, interfaces and in nanoscale objects?
5. How does long range order evolve near a quantum critical point at very low temperature and high magnetic field or high pressure?

The significantly enlarged portfolio of X-ray spectroscopy techniques, the improved performance of the instruments, and the ability to apply many methods to the same problem will dramatically change the science that will be achieved in the coming years. Studies under

extreme conditions of temperature, pressure, electric and magnetic fields will provide vital input for various technological developments in, for example, microelectronics, energy and data storage, and thermoelectric materials, and will address longstanding open questions in fundamental research such as strongly correlated electron systems.

Expected user communities

The improved performance and accessibility of the experimental stations, together with the proposed new instruments, will attract new users, in particular in research fields such as magnetism, dynamics of (bio-) materials and nanotechnology. Advances in instrument and control development as well as data handling and analysis will make the challenging experiments of today routine, and will render the experimental stations accessible as well to scientists outside of the traditional synchrotron radiation user community. These users will strongly benefit from cross-disciplinary partnerships. For example, the unique European High Magnetic Field Laboratory will be used by a community of researchers, from biologists to physicists.

Enabling technology and infrastructure

The success of these scientific projects is closely linked to the detector and optics developments and the fact that all aspects of the sample environment form core components of the Upgrade enabling technology programme. Substantial upgrades in the ancillary facilities of the ESRF will be made, most notably for the off- and online preparation and complementary characterisation of the samples.

- *Buildings and infrastructure*: Extension to long beamlines and laboratories for sample preparation and characterisation.
- *Accelerator and source*: Timing modes in top-up operation, increased flux and extremely high beam stability, lower emittance.
- *Beamlines and instrumentation*: Ultra-fast time-

resolved detectors for high energies. Nanofocusing X-ray optics developments. High thermal stability of optics and sample environment. Access to high magnetic fields.

- *Computing*: Fast data reduction and analysis.

Partnerships

The development of a European High Magnetic Field Laboratory in collaboration with the ILL and a consortium of high magnetic field laboratories will provide a unique X-ray and neutron facility for the study of matter.

1.4.1. Introduction

An integrated approach is required to fully understand the complex microscopic phenomena which govern the macroscopic physical, chemical and dynamic properties of condensed and biological matter and define their function. Experimental techniques from both laboratory methods and instruments at large-scale facilities should be used in parallel. The power of X-ray spectroscopy and scattering techniques lies in the unique properties of the X-ray probe in terms of selectivity, time structure and polarisation characteristics, combined with its capability to provide nanometre-sized beams. The Upgrade Programme offers a new suite of instruments with significantly improved characteristics (throughput, energy- and spatial resolution). This will permit current techniques to be improved as well as making some new unique applications possible. These are highlighted in this chapter.

Section 1.4.2 describes the major advances in the field of electron correlation and magnetism. This field has strong links to research on nanoscale materials, most notably apparent in the study of low dimensional magnetic systems at surfaces (**section 1.1.4**), and to some of the more classical fields of materials science (*see chapter 1.3*). The most ambitious of the related projects involve static and pulsed very high magnetic fields (*see chapter 2.4*) and the study of magnetic dynamics in the frequency domain through pumping with a strong microwave field (*see chapter 2.4*).

Section 1.4.3 covers the field of collective motions of atoms, closely linked to various fields of materials science (*see chapter 1.3*) and soft condensed matter (*see section 1.2.4*). It also incorporates biological applications and studies on surfaces and nanoscale objects. Here the emphasis is on phonon- and phonon-like excitations, whereas slower, diffusive motions are treated in **section 1.2.4**. Better energy resolution, access to more Mössbauer isotopes, and higher throughput will create new research possibilities, for example, for studies under extreme conditions and of nanoscale materials (**chapter 1.1**).

The new possibilities envisaged by the large volume press and *in situ* laser heating will enlarge the scope of research possible within the scientific fields discussed in this chapter. Challenges related to extreme conditions, especially high pressure, are discussed in more detail in **section 1.3.4**.

The experimental upgrades proposed in this chapter depend crucially on improvements in machine performance (optimised time structures, higher flux and very stable operation) and substantial detector developments. Furthermore, certain associated

support facilities will also have to be implemented, in particular for sample preparation and characterisation. The creation of a high magnetic field laboratory should be a joint effort between the ILL and the European magnetic field laboratories (Dresden, Grenoble, Leuven, Nijmegen, Toulouse and others).

Improvements in experimental techniques and facilities have to be made in strict concordance with theoretical advances. Therefore, the presence of a strong joint ESRF-ILL theory group is indispensable in this respect. Furthermore, the availability and further development of *ab initio* computer algorithms for the calculation of structural, dynamic and electronic properties, as well as large-scale molecular dynamics simulations, will provide important input for experimental preparation and data analysis.

1.4.2. Electron correlation and magnetism

The study of correlated electron systems, nanomagnetism and dynamic properties covers several very important areas in contemporary science. Both the crystalline structure and its dynamic properties, and the electronic and magnetic properties, including their dynamics, need to be investigated. Understanding the rich variety of physical phenomena that arise from correlation effects, reduced dimensionality and their dynamic properties is a challenge. To quote an example, the origin of high-temperature superconductivity is still unknown and the electronic and dynamic properties of correlated materials are still not understood. Theory needs to be developed to understand these problems and it is essential to have experimental methods that can address the many different aspects of the problem. A variety of complementary techniques need to be applied to achieve this. X-ray spectroscopy techniques have an important role to play here due to their unique element, orbital and isotope sensitivity and intrinsic time information. In addition, the high brilliance of synchrotron radiation sources makes it possible to dramatically extend the phase space accessible using high pressure, high magnetic fields (pulsed and static), low and high temperatures, as well as other external parameters such as electric fields. Herein lies one of the great strengths of the proposed strategy for the future. The combination of synchrotron radiation techniques with neutron and muon probes as well as *in situ* laboratory-based methods, will further help in the understanding of the structure of materials, static and dynamic electronic correlations and collective excitations. These features will be implemented within the framework of the Upgrade Programme.

Special emphasis will be given to new infrastructure. The proposed installation for very high static and pulsed magnetic fields (see [chapter 2.4](#)) will make totally new scientific areas accessible (see the example on URu_2Si_2 below). In addition, the *in situ* characterisation of samples requires an indispensable variety of synchrotron and complementary laboratory-based techniques if the most complete results possible are to be obtained. To achieve this, construction of instrumentation for extreme conditions (*e.g.* cryomagnets with low temperature and high-pressure capabilities), specialised detectors and state-of-the-art beamlines (*e.g.* improved energy resolution) is planned. Beam parameters including time-structure, beam stability, intensity, sub-micrometre beam sizes, and polarisation properties are of vital importance. All of these developments will enable new science. The research fields where major advances can be expected are highlighted below.

Complex materials and correlated electron systems

The appearance of spontaneous long-range order at low temperatures is a fundamental phenomenon of condensed matter physics. Ferromagnetism, antiferromagnetism, and superconductivity are all ordered phases sharing fundamental properties and characteristics in which some relevant physical property, the so-called order parameter, shows a marked difference above and below a critical temperature T_C . The microscopic origin of these phase transitions is related to the electronic degrees of freedom which promote structural modifications, transport effects, and magnetically or electronically ordered phenomena. Each type of ordered phase is associated with a broken symmetry, and the order parameter, which drives the symmetry-breaking transition, can be finely tuned by external thermodynamic variables such as temperature, pressure, and electric or magnetic fields. The investigation of the order parameters and their evolution as a function of the thermodynamic variables is one of the main research fields in the domain of strongly correlated electron systems and complex materials in which different and often competing order parameters are present, giving rise to many spectacular manifestations of quantum physics in condensed matter.

Many transition metal oxides exhibit interesting long-range ordered electronic states, such as ferroelectricity, colossal magneto-resistivity, high- T_C superconductivity or magneto-electricity. Modifications whereby two, or more, of these electronic properties coexist may produce a startling synergy in the combined complexity of the materials. For example, the multi-ferroics is a class of compound possessing more than one "ferroic" order (which

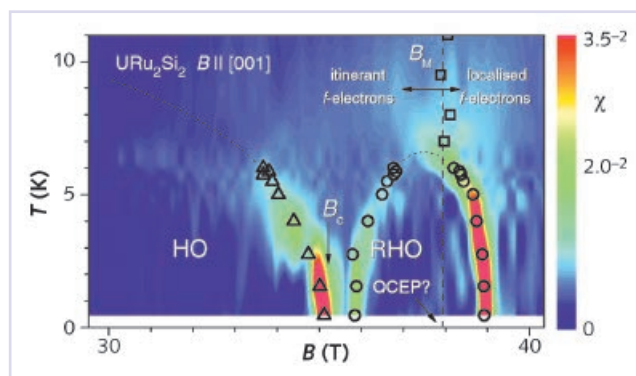

Figure 1.4.1: The magnetic field-temperature phase diagram of URu_2Si_2 combined with a colour intensity plot of the magnetic susceptibility, χ (Harrison *et al.*, 2003). The high magnetic field facility proposed in the Upgrade Programme will allow X-ray resonant scattering, X-ray magnetic circular dichroism, and nuclear resonance scattering studies of the field-stabilised re-entrant hidden order phase (RHO). Unlike neutron techniques, X-rays are sensitive to a long-range order of quadrupole and higher order multipole moments.

include long-range magnetism, ferroelectricity and elastic distortion), and comprises exceptional materials, whose electric or magnetic polarisation can be controlled by a magnetic field. Such materials are not only of fundamental scientific interest but also have great potential as an alternative route to spintronic devices, and make a number of technological applications possible. Many experimental methods are already being employed to study these effects, but X-rays, in particular methods created by the Upgrade Programme such as the very high static magnetic fields (see [chapter 2.4](#)), will make new science possible. To give an example, X-ray magnetic scattering can determine the long-range multipole order of the states that give rise to these interesting phenomena, while X-ray spectroscopic methods have the unique ability to measure the element, isotope, and shell dependent properties. If pulsed magnetic fields are utilised, even higher values can be obtained, and the first X-ray studies (diffraction and nuclear forward scattering) have already been performed. The pulsed magnetic field project (see [chapter 2.4](#)) aims to develop the scientific case and to prepare the ground for the planned high magnetic field laboratory.

In systems displaying quantum critical effects, the primary order parameter can be suppressed externally by applying chemical (substitution) or hydrostatic pressure and/or magnetic fields. Thermal fluctuations are reduced as the ordering temperature approaches zero until the phase transition is governed by quantum fluctuations. Electron correlations beyond the primary interaction play a major role in this. Phenomena related to quantum criticality have been

observed in many classes of materials, *e.g.* low-dimensional magnetic materials. An intriguing example can be found in URu_2Si_2 . Below 17 K, the system undergoes a phase transition clearly observed in macroscopic measurements. The nature of the ordered state, however, remains unclear. Neutron diffraction has shown that the transition does not involve antiferromagnetic order of magnetic moments, and hence the low-temperature state was nicknamed the “hidden order phase” (HO). If magnetic fields between 32 T and 40 T are applied, URu_2Si_2 undergoes metamagnetic transitions, including a “re-entrant hidden order phase” (RHO) between 36 T and 39 T (see Figure 1.4.1) (Harrison *et al.*, 2003). Potential studies under very high static magnetic fields in conjunction with X-ray techniques such as resonant X-ray diffraction, X-ray magnetic circular dichroism (XMCD) at the U $M_{4,5}$ edges, and nuclear resonance scattering (NRS, utilising the uranium isotope ^{238}U), will provide much needed insight into the size of the assumed superstructures; the role of spin and orbital contributions to the $5f$ magnetic moments will also be determined. Furthermore, these techniques can probe the role of quadrupolar moments in the phase transitions and eventually detect higher order multipole moments. A similar “hidden order” problem in NpO_2 was recently solved after the long-range order of quadrupole moments was detected by resonant X-ray scattering (Paixão *et al.*, 2002).

The interplay of magnetism and superconductivity is another fascinating topic. Magnetic interactions and magnetic impurities are destructive to superconductivity in conventional superconductors. However, in some unconventional heavy-fermion superconductors, such as ferromagnetic UGe_2 , the superconductivity is actually mediated by magnetic interactions. A magnetic mechanism has also been proposed for high-temperature superconductivity.

Moreover, application of a high magnetic field to antiferromagnetic superconductors might lead to a reappearance of superconductivity or even induce it in some 2D organic conductors.

Developing theoretical models that aim to calculate the electronic structure and to treat electron–electron interactions correctly is a challenge (see section 2.4.3). Input is required in the form of energy position, dispersion, orbital symmetry and possibly the lineshape of the electronic excitations. An elegant way of measuring these excitations is provided through resonant inelastic (soft and hard) X-ray scattering (RIXS) and through non-resonant inelastic hard X-ray scattering (NRIXS) spectroscopy. Both of these techniques, whose further development plays an important role in the Upgrade Programme, keep the total charge of the system the same. This means that excited states of less than 1 eV above the ground state can be accessed. RIXS techniques exploit the resonant enhancement of the scattering cross-section to access weak excitations that would otherwise be barely accessible. In contrast, although NRIXS techniques are count-rate limited, they offer results that are more easily interpretable thanks to the simpler expression of the cross-section. NRIXS techniques are gaining interest for two main reasons: i) they are compatible with extreme conditions, most importantly high pressure; ii) the advent of high-performance multi-crystal spectrometers, which use novel 2D detection schemes based on silicon pixel detectors (see chapter 2.5), makes it possible to perform experiments with energy resolutions down to 100 meV or better. This is mandatory for low-lying electronic excitations such as dd excitations in cuprates, titanates and vanadates.

Complementary information on inelastic scattering can be gained from photoelectron techniques. These allow the band structure and electronic structure of a material to be determined. Soft and hard X-rays are important where more bulk sensitivity is

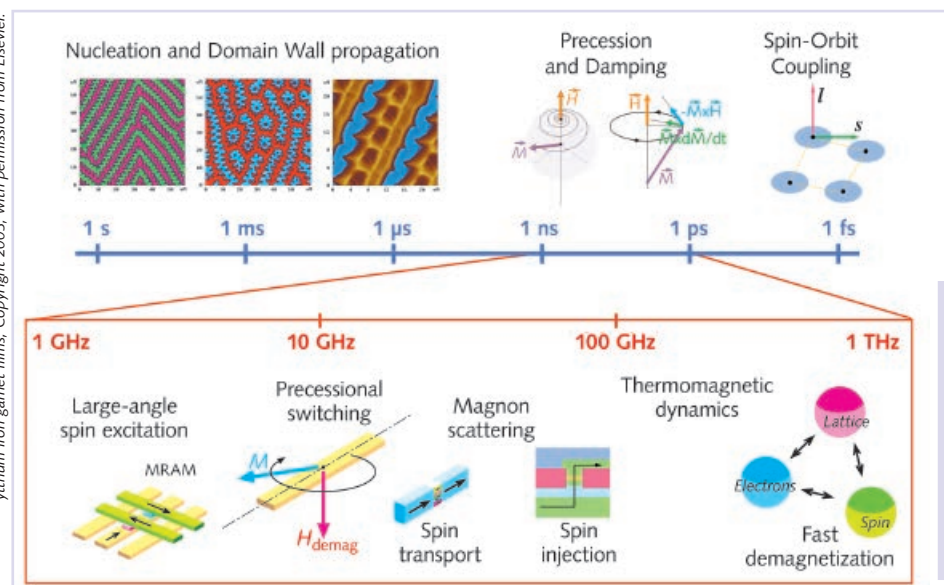

Figure 1.4.2: Major processes involved in magnetisation dynamics on the timescale down to femtoseconds. The Upgrade Programme will make access to these regimes possible by the development of new time-resolved and frequency domain X-ray spectroscopy techniques together with new detector systems.

needed and this is particularly true for strongly correlated materials, *e.g.* cerium compounds. Soft X-ray angle-resolved photoelectron spectroscopy is a powerful tool for the determination of bulk 3D Fermi surfaces. Such information is imperative for understanding the electronic properties of complex materials, both in applied and basic science. For instance, the properties of multiferroic materials, superconductors and materials exhibiting unusual magnetoresistance phenomena are mainly determined by their Fermi surface. Hard X-rays can also look at buried structures and combine structural information, for example by utilising standing waves to give site-specific electronic structure. X-rays also allow element-specific information to be gained by utilising excitation at the atomic resonances; this information is often unique to X-rays.

Dynamics of magnetic systems

A large proportion of contemporary technology, from electric transformers to magnetic recording, uses a process involving the switching of the direction of magnetisation. Many studies aimed at achieving a fundamental understanding of the mechanisms of magnetisation dynamics and switching have been undertaken because of the need to enhance the speed of modern spintronic and magneto-optic devices and to further develop magnetic storage technology.

Major processes involved in magnetisation dynamics on the timescale down to femtoseconds are shown in [Figure 1.4.2](#). At low frequencies, magnetic domain wall propagation governs the response of the magnetic system when a change of the direction of an applied field occurs. However, for shorter timescales and at gigahertz frequencies and above, precession and spin-lattice relaxation are the dominant processes. This gives rise to several fundamental questions about the basic mechanism of magnetic damping, and the ultimate speed with which magnetisation can be reversed.

Magnetisation dynamics can be studied using various approaches both in the time domain (*e.g.* with pulsed magnetic fields) and in the frequency domain (*e.g.* by microwave excitation). In the fast time domain, time-resolved X-ray spectroscopy techniques are valuable tools when addressing dynamic problems. A new method in the frequency domain has emerged very recently (Goulon *et al.*, 2005), namely X-ray detected magnetic resonance (XDMR). It is one of the aims of the Upgrade Programme to bring this technique to maturity (*see* [chapter 2.4](#)). The frequency range of the pump waves is very large, from a few megahertz with nuclear magnetic resonance and extending to the terahertz range for antiferromagnetic resonance. This makes it possible to measure the ellipticity of the precession trajectories of spin and orbital

magnetisation components for various absorbing atoms, and to study large-angle spin excitations and precessional switching with high power microwaves and the SWASER (spin wave amplification by stimulated emission of radiation) regime in spin valves. Extension to the terahertz range would allow studies of magnetic relaxation processes in Van Vleck paramagnets. Research on the existence of new types of optical modes involving strongly coupled magnetisation components of a spin and orbital nature will also take place. The terahertz regime will require very high magnetic fields (30 to 40 T) and will be complementary to X-ray free-electron laser studies in the time domain.

Several other techniques, such as X-ray photoemission electron microscopy (XPEEM), X-ray photon correlation spectroscopy (XPCS), and nuclear resonance scattering techniques (NRS) are expected to provide further valuable information. XPEEM allows one to visualise domain dynamics on various timescales from seconds (*e.g.* domain wall melting) to sub-nanosecond (*e.g.* magnetic vortex rotation) in the surface. In comparison, X-ray scattering techniques also offer bulk sensitivity and ensemble average information. For example, the coarsening of antiferromagnetic domains driven by a spin-flip transition induced by small external magnetic fields (Nagy *et al.*, 2002) can be studied. Critical fluctuations and relaxation phenomena in magnetic systems are another important research area. The application of pulsed high magnetic fields fits well into this time regime and offers new scientific possibilities with fields beyond 25 T.

Nanomagnetism

Structural and magnetic/electric properties of condensed matter as well as their underlying dynamics are of paramount importance for the functionality of future nanoscale devices. The role of the interfaces between adjacent materials becomes increasingly important with the decreasing size of the structural units, and novel dynamic phenomena are expected in these nanostructures. New methods have to be developed for experimental characterisation and theoretical modelling as the properties of low dimensional structures are significantly different from those of corresponding bulk materials. One of the future scientific challenges will be to study the magnetisation in nanoscale materials and, in particular, its dynamics. Selected highlight areas such as spintronics, nanoscale objects, molecular magnetism, and nanotechnological applications are discussed below.

The recent advent of the new technological and research fields magnetoelectronics and spintronics, in which magnetism and electronic properties of solids

are combined to exploit spin-dependent transport processes. This creates novel functionalities that have already entered the market, for example, in hard disk read heads and non-volatile, magnetic random access memory. The continuing need to increase information storage density has led to the development of smaller and smaller magnetic bits called nanomagnets. The impact of nanomagnetism is not, however, limited to just technological advances. Several new phenomena, at the forefront of research, such as spin-torque transfer, spin-current induced magnetic switching, or spin-current induced microwave generation, have been discovered very recently. These discoveries were only possible because of the ability to fabricate magnetic nanostructures with a typical size below 100 nm. In the future, the challenge lies in understanding and controlling magnetism and magnetic phenomena on these very small length scales and in reduced dimensions. The relevant physical systems range from thin films and multilayers through quantum wires and quantum dots down to nanoparticles, magnetic molecules, or even single magnetic atoms on a surface.

Thin films and their interfaces play a crucial role in modern technology such as spintronics and advanced magnetic materials. Their properties are better investigated using the isotope-selective techniques that are possible using synchrotron radiation. For example, the spin structure of each layer in a magnetic film can be determined by X-ray scattering or nuclear resonance techniques (Röhlsberger *et al.*, 2002) as shown in Figure 1.4.3.

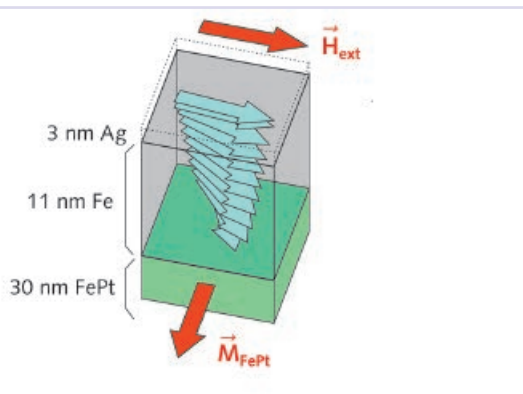

Figure 1.4.3: Magnetic structure in the iron layer of an Fe/FePt exchange spring as it forms in an external magnetic field of 160 mT. The spin structure has been directly measured by grazing incidence nuclear resonance scattering with atomic depth resolution utilising the probe layer technique. Future challenges are a combination of this technique with a nano X-ray beam to allow an entire spatial mapping with nanometre resolution, to study real devices such as spin valves.

Reducing the dimensionality dramatically changes the possibility of obtaining long-range magnetic order. Nano-objects, such as one-dimensional systems, can be used to study effects where the interplay between

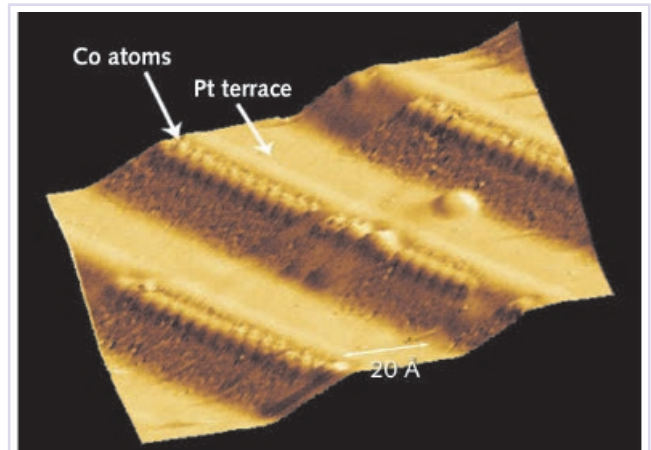

Figure 1.4.4: Cobalt atomic wires decorating the steps of a platinum (111) vicinal surface (Gambardella *et al.*, 2002).

Reprinted by permission from Macmillan Publishers Ltd. Nature, P. Gambardella, A. Dallmeier, K. Maiti, M.C. Malagoli, W. Eberhardt, K. Kern, C. Carbone, Ferromagnetism in one-dimensional monatomic metal chains, Nature 416, 301-304, copyright 2002. <http://www.nature.com>

finite size effects and electronic interactions is marked, such as exchange and spin-orbit coupling. An example of such research is the study of spin fluctuations in a one-dimensional system.

Figure 1.4.4 shows how a nanowire of cobalt atoms can be fabricated on a stepped platinum surface (Gambardella *et al.*, 2002). Spin blocks are expected to form along the wire and studies of such a system should help understanding the role of critical fluctuations in low-dimensional systems. Soft X-ray magnetic scattering measurements will be able to probe length scales of ~ 6 nm (Dürr *et al.*, 2007) and determine the size of the spin blocks. Beyond this, the dynamics of low dimensional systems can be studied using fluctuation spectroscopy. The use of the X-ray beam coherence will enable magnetic speckle to be measured, which will make it possible to reconstruct the real space image from the scattering signal. Time-resolved studies of this type will be a real challenge but could offer unique insight into magnetisation dynamics on the nanoscale.

A relatively recent scientific field that deserves to be mentioned is molecular magnetism. This is one of the most attractive areas of investigation for new magnetically ordered materials and is an interdisciplinary field in condensed matter in which chemists and physicists combine their efforts in designing and synthesising new bulk magnets starting from molecular blocks. The scientific interests span from fundamental research, such as frustrated magnetism, low-dimensionality and superparamagnetism to applied research in the fields of quantum dots and nanowires, with potential technological applications in data storage, spin-valve devices, and biomedical nanotechnologies. The scaling of magnetic objects to the nanometre size introduces new physical functionalities and properties, providing ideal laboratories for the study of nanoscale magnetic phenomena. Element, isotope, and orbital selective information provided by X-ray resonant magnetic spectroscopy, X-ray scattering, and

nuclear resonant scattering are powerful tools for unravelling the role of each element in the magnetic interactions of molecular magnets.

The future of nanotechnological applications of magnetic nanoparticles (diameter < 10 nm) depends on the control of their monodispersity and surface properties. Their relevance lies in the huge potential for applications in information technology, novel macroscopic magnetic materials, and in medicine, providing a biocompatible coating around a magnetically stable core with a large magnetic moment.

All of these challenging nanomagnetism projects require new integrated approaches, exploiting the whole suite of synchrotron radiation-based techniques. The availability of advanced on- and off-line sample preparation and characterisation facilities is also mandatory. The Upgrade Programme is indispensable in implementing this new strategy.

Relevant Conceptual Design Reports:

- **DICHRO:** Polarisation Dependent X-ray Spectroscopy
- **HXPM:** Hard X-ray Photoelectron Microscopy
- **INELX:** Inelastic X-ray Scattering
- **MAGSCAT:** Magnetic Scattering
- **NR-HE:** Nuclear Resonance – High Energy
- **NR-NSM:** Nuclear Resonance – Nanoscale Materials
- **PMF:** Pulsed Magnetic Fields
- **RIXS-PES:** High Resolution Resonant Inelastic X-ray Scattering and Photoelectron Spectroscopy
- **SMS:** Resonant Soft X-ray Magnetic Scattering
- **XAS-XES:** Steady-State and Time-Resolved X-ray Absorption and Emission Spectroscopy

Key enabling technologies and infrastructures:

- **Detectors:** 2D pixel detectors, UHV compatible detectors (**SMS**, **RIXS-PES**). Fast 2D (pixel) detector with at least 1 kHz frame rate (**PMF**). Fast (100 ps to ns time resolution) detector systems for high energies (\rightarrow 100 keV); fast 2D pixel detector (\sim 1 ns, 100 $\mu\text{m} \times$ 100 μm pixel size) (**NR-HE** and **NR-NSM**).
- **Buildings:** Long beamline (>100 m) to accommodate backscattering monochromator (**NR-HE**). Long beamline (250 m) to obtain a focal spot of 0.1 $\mu\text{m} \times$ 1 μm keeping the full flux (**NR-NSM**).
- **Infrastructure:** Support laboratories for sample preparation and characterisation, nano- and micro manipulation tools, *e.g.* surface science laboratory, characterisation of magnetic properties and phase transitions. (**DICHRO**, **MAGSCAT**, **PMF**, **SMS**, **RIXS-PES**). Extension of experimental hall and supporting infrastructure for high static magnetic fields.

1.4.3. Collective motion of atoms

The experimental determination of the vibrational properties of matter provides important information on elastic and thermodynamic properties, the interplay between electronic, magnetic and lattice degrees of freedom, as well as relaxation mechanisms in topologically disordered systems. Techniques such as Brillouin and Raman light scattering, ultrasound techniques and infrared spectroscopy are limited to momentum transfers close to zero and consequently probe the dynamics over macroscopic length scales. Access to the mesoscopic region, corresponding to nanometre length- and picosecond timescales, is provided by inelastic neutron and X-ray techniques (in addition to exclusively surface-sensitive methods such as electron energy loss spectroscopy and helium scattering). The uniqueness of synchrotron radiation-based techniques resides in the following points: (i) there is no fundamental restriction (besides energy resolution) in the explorable energy-momentum transfer region, (ii) motions of a specific atom species can be singled out (provided that it possesses a Mössbauer isotope), and (iii) X-rays can be focused down to sub-micrometre sized beams, allowing experimental access not only to nanoscale materials, but also to samples confined in extreme environments such as diamond-anvil cells and high magnetic fields. Inelastic X-ray (IXS) and nuclear inelastic scattering (NIS) have greatly contributed to the advancement in many fields of research (Krisch and Sette, 2007; Chumakov and Sturhahn, 1999). Examples comprise the nature of sound propagation at terahertz frequencies in disordered systems, phonon dispersion and density-of-states in tiny amounts of materials, thin films and at surfaces, and studies under extreme conditions of pressure beyond 10 GPa.

Major breakthroughs can be expected by a further improvement in the instrumental energy resolution towards 0.1 meV, a significant increase in the detection efficiency, and upgrade of the X-ray source. The Upgrade Programme will make it possible to study an E - Q region that has, to date, never been explored (see **Figure 1.4.5**). The next generation of instruments will permit the investigation of increasingly complex materials and samples, necessitating a sophisticated environment. In particular, extreme pressures and temperatures will be reachable, and the dynamics of surfaces and nanoscale systems can be given routine access. The planned improvements in terms of spectrometers and detector efficiency will lead to an important reduction in the data acquisition time. Typically, measurements that currently require a week of beam time, will be feasible in less than a day. The main advances that are predicted are highlighted below.

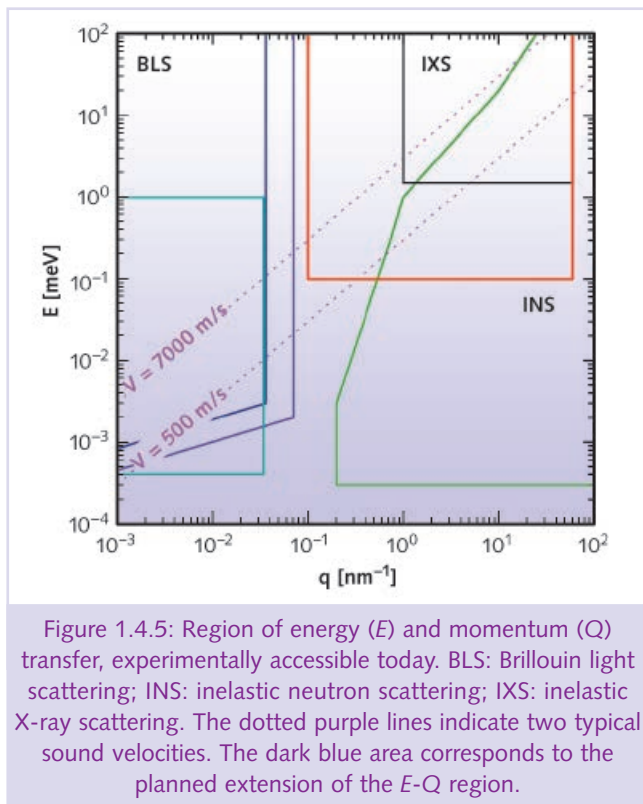

Glasses and liquids

Inelastic X-ray and nuclear scattering techniques have contributed significantly to our understanding of the vibrational excitations in glasses in the millielectronvolt energy range (Sette *et al.*, 1998; Chumakov *et al.*, 2004). Glasses exhibit low-temperature universal anomalies in their specific heat and thermal conductivity, whose microscopic origin has to be related to a universal behaviour of the low-energy excitations, in particular in acoustic form. Specifically, at around 10 K, glasses are characterised by a plateau in the thermal conductivity and by an excess in the specific heat over the Debye level (Pohl *et al.*, 2002). The latter has a spectroscopic counterpart in the vibrational density of states (DOS) known as the boson peak and located at a few millielectronvolts (see Figure 1.4.6).

The current limitations, mainly related to resolution, of the inelastic X-ray and nuclear scattering techniques mean that acoustic excitations and the vibrational DOS can be studied only around and above the boson peak energy (corresponding to temperatures above approximately 25 K). This mesoscopic range does not yet correspond to the macroscopic range usually studied using laboratory techniques such as ultrasonics and light scattering. Unfortunately, the crossover energy and momentum range from the macroscopic to the mesoscopic limit cannot be studied using any experimental technique. It is worthwhile underlining that computer simulation techniques cannot access this range either due to the

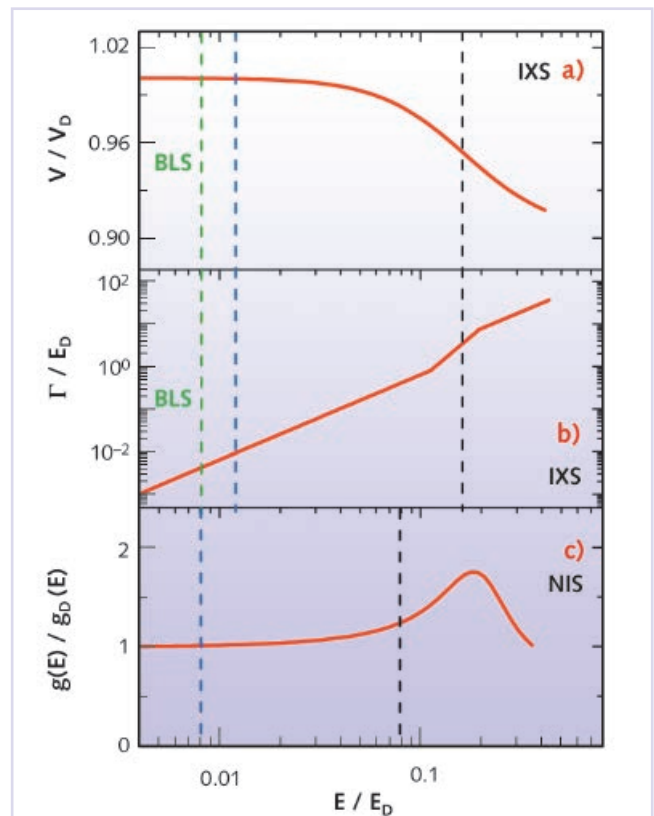

excessive size of the simulation box that would be required.

The Upgrade Programme will improve the energy resolution towards 0.1 meV, implementing recently developed novel monochromatisation schemes (Shvyd'ko *et al.*, 2006). This optics development is also being intensively pursued at the APS and SPRING-8. The ESRF, together with the two other sources, can act as pioneers for the new medium-energy sources such as ALBA, Diamond, NSLS-II and Soleil. The study of the acoustic excitations and vibrational DOS in this range will reach a point where the concept of macroscopic elasticity can no longer be applied in a glass. It will therefore provide a microscopic basis for the aforementioned universal anomalies of glasses.

Improved energy resolution will also have a significant impact as far as the study of liquids is concerned. In fact, the energy-momentum range,

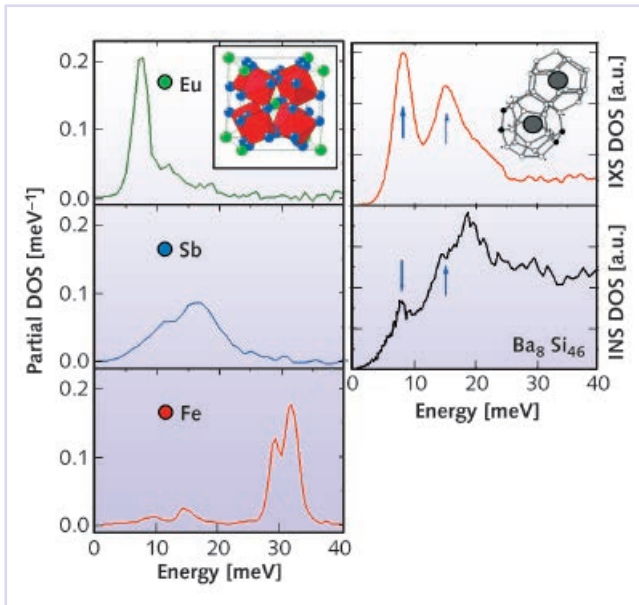

Figure 1.4.7: (left) Partial phonon density of states of the skutterudite $\text{EuFe}_4\text{Sb}_{12}$ as obtained by nuclear inelastic scattering, which provides unique species-sensitivity. The iron atoms are at the centres of the red octahedra. Adapted from Wille *et al.* (2007). (Right) X-ray (red) and neutron (black) generalised phonon density-of-states of $\text{Ba}_8\text{Si}_{46}$. The blue arrows indicate the localised modes of the Ba atom in the cages (Machon *et al.*, 2007).

whereby macroscopic elasticity breaks down in a glass, corresponds to the range where macroscopic viscoelasticity breaks down in a liquid. The Upgrade Programme will enable the gap to be bridged between the viscoelastic formalism valid in the macroscopic range and the generalised hydrodynamic formalism valid in the mesoscopic range. This will provide unique data for testing models and theories on the dynamics of liquids, and important advances could be made in this scientific field, where a unified picture is still not apparent. Moreover, reaching the

macroscopic limit with inelastic X-ray scattering techniques will also make it possible to measure relevant thermodynamic and transport properties (sound velocity, viscosity) on a class of systems (such as low-viscosity fluids and dense gases) where the structural dynamics takes place on a picosecond timescale. This would be of particular interest for geophysical and planetary science.

Crystalline systems

Studies of crystalline materials in very small quantities and at extremely high pressures (typically above 10 GPa) will continue to be an important part of the future research programme. Furthermore, an integrated approach, using synchrotron radiation-based techniques such as IXS, NIS and thermal diffuse scattering (TDS), as well as inelastic neutron scattering, will provide a complete and detailed picture of the lattice dynamics for increasingly complex systems. This is illustrated in Figure 1.4.7 for a filled skutterudite (Wille *et al.*, 2007) and a Ba–Si clathrate (San Miguel and Bosak, 2007), where the contrast difference – arising from the selectivity of Mössbauer isotopes and the different scattering strengths for neutrons and X-rays – is utilised to single out the dynamics of a specific constituent element. The ability to use (textured) polycrystalline samples to determine single crystal elastic properties, and even the full phonon dispersion in favourable cases, will create new opportunities in materials research in cases where single crystals cannot be synthesised. This new data acquisition strategy consists of recording spectra over a large Q -range (typically 2 to 70 nm^{-1}), and then performing a least-squares refinement of the lattice dynamics model in order to extract single crystal properties. First studies have proven the feasibility of such an approach (see Figure 1.4.8). Another example is the study of soft modes in charge-density-wave systems, or correlated electron systems in general, where TDS provides a

Figure 1.4.8: (left) IXS intensity as a function of momentum transfer for polycrystalline beryllium and (right) extracted single crystal phonon dispersion in the basal plane after least-squares refinement of the lattice dynamics model: INS measurements (circles), fitted results (red lines) and model calculations (blue lines) (Fischer *et al.*, 2007). The Upgrade Programme will permit the simultaneous recording of the IXS spectra over the entire Q -range, thus reducing the data collection time from days to hours.

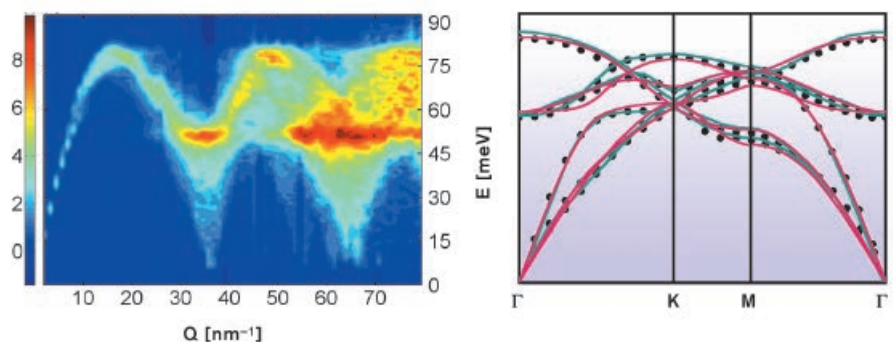

very rapid overview of the regions of interest in reciprocal space, and IXS is subsequently used to map out the details of the soft phonon branch.

The experimental studies have to be carried out in collaboration with further theoretical advances to treat the lattice dynamics of complex materials from first principles. Finally, the availability of lattice dynamics software packages will play an increasingly important role, not only in data analysis and reduction, but also in the preparation of experiments.

Surfaces, nanoscales and confined geometries

The study of collective dynamics in crystalline, glassy, or liquid aggregate states will make tremendous progress thanks to the Upgrade Programme, namely, they will become applicable to nanoscale objects. Measurements of both dispersion relations and density of states have already been successfully performed on surface layers of a few nanometres and a monoatomic layer, respectively. The foreseen increase in flux, optics throughput, and detector efficiency as well as improved focusing capability, will allow frontier-science investigations to be tailored to samples ranging from microcrystals to nanoscale materials. Studies of dispersion relations and density of states of nano-objects with a typical size of about 10 nm will then be feasible. For example, routine studies of the collective dynamics in crystalline nanoislands, glassy clusters, or liquid nanodrops can be envisaged. Investigations of dynamics in confined geometries such as single nanoporous channels or isolated, single nanotubes may become possible. Moreover, access to sub-nanometre, *i.e.* quantum-size objects, could be gained in some specific cases. To give an example, the high sensitivity and unique isotope selectivity of nuclear inelastic scattering will allow studies of collective dynamics of self-organising surface structures with sub-monolayer surface coverage to be carried out.

Relevant Conceptual Design Reports:

- INELX: Inelastic X-ray Scattering
- NR-HE: Nuclear Resonance - High Energy
- NR-NSM: Nuclear Resonance - Nanoscale
- PHIXS: Phonon Inelastic X-ray Spectroscopy Materials

Key enabling technologies and infrastructures:

- Detectors: Development of special arrays of point detectors with specific geometrical constraints and a very low background noise (10^{-3} Hz) (PHIXS and INELX). NR-NSM/NR-HE: *see section 1.4.2.*
- Buildings: NR-NSM/NR-HE: *see section 1.4.2.* Long beamline (150 m) for a hutch with 16 to 20 m transversal size (INELX). Highly stable and temperature controlled crystal optics (0.001 to 0.01 K) for all projects.
- Infrastructure: Support laboratory for *in situ* UHV preparation, characterisation of nano-objects (NR-HE, NR-NSM); AFM, STM and microscopy compatible stable environment; access to high magnetic fields (NR-HE, NR-NSM).

References

- Chumakov A.I. and Sturhahn W. (1999), Experimental aspects of inelastic nuclear resonance scattering, *Hyperfine Interact.*, **123/124**, 781-808.
- Chumakov A.I., Sergueev I., van Bürck U., Schirmacher W., Asthalter T., Rüffer R., Leupold O., and Petry W. (2004), Collective nature of the Boson peak and universal transboson dynamics of glasses, *Phys. Rev. Lett.*, **92**, 245508.
- Dürr H., Gambardella P., and Carbone C. (2007), Spin fluctuations in monoatomic Co wires probed by soft X-ray resonant magnetic scattering, private communication.
- Fischer I., Bosak A., Mirone A., and Krisch M. (2007), to be published.
- Gambardella P., Dallmeyer A., Maiti K., Malagoli M.C., Eberhardt W., Kern K., and Carbone C. (2002), Ferromagnetism in one-dimensional monoatomic metal chains, *Nature*, **416**, 301-304.
- Goulon J., Rogalev A., Wilhelm F., Jaouen N., Goulon-Ginet C., Goujon G., Ben Youssef J., and Indenbom M.V. (2005), X-ray detected magnetic resonance at the Fe K-edge in YIG: Forced precession of magnetically polarized orbital components, *JETP Lett.*, **82**, 696-701.
- Harrison N., Jaime M., and Mydosh J.A. (2003), Reentrant hidden order at a metamagnetic quantum critical end point, *Phys. Rev. Lett.*, **90**, 096402.
- Krisch M. and Sette F. (2007), Inelastic X-ray scattering from phonons, in *Light Scattering in Solids IX Novel Materials and Techniques*, edited by M. Cardona and R. Merlin. Berlin, Heidelberg: Springer Verlag.
- Machon D., San Miguel A., Toulemonde P., Bosak A., and Krisch M. (2007), *Dynamic and electronic coupling of encaged atoms in the Ba₈Si₄₆ clathrate*, to be published.
- Nagy D.L., Bottyán L., Croonenborghs B., Deák L., Degroote B., Dekoster J., Lauter H.J., Lauter-Pasyuk V., Leupold O., Major M., Meersschant J., Nikonov O.,

- Petrenko A., Ruffer R., Spiering H., and Szilágyi E. (2002), Coarsening of antiferromagnetic domains in multilayers: the key role of magnetocrystalline anisotropy, *Phys. Rev. Lett.*, **88**, 157202.
- Paixão J.A., Detlefs C., Longfield M.J., Caciuffo R., Santini P., Bernhoeft N., Rebizant J., and Lander G.H. (2002), Triple-q octupolar ordering in NpO_2 , *Phys. Rev. Lett.*, **89**, 187202.
 - Pohl R.O., Liu X., and Thompson E. (2002), Low-temperature thermal conductivity and acoustic attenuation in amorphous solids, *Rev. Mod. Phys.*, **74**, 991-1013.
 - Röhlberger R., Thomas H., Schlage K., Burkel E., Leupold O., and Ruffer R. (2002), Imaging the magnetic spin structure of exchange-coupled thin films, *Phys. Rev. Lett.*, **89**, 237201.
 - San Miguel A. and Bosak A. (2007), unpublished results.
 - Sette F., Krisch M.H., Masciovecchio C., Ruocco G., and Monaco G. (1998), Dynamics of glasses and glass-forming liquids studied by inelastic X-ray scattering, *Science*, **280**, 1550-1555.
 - Shvyd'ko Yu.V., Lerche M., Kuetgens U., Rüter H.D., Alatas A., and Zhao J. (2006), X-ray Bragg diffraction in asymmetric backscattering geometry, *Phys. Rev. Lett.*, **97**, 235502.
 - Wille H.-C. Hermann R.P., Sergueev I., Leupold O., van der Linden P., Sales B.C., Grandjean F., Long G.J., Ruffer R. and Shvyd'ko Yu.V. (2007), Antimony vibrations in skutterudites probed by ^{121}Sb nuclear inelastic scattering, to be published.

1.5. Emerging scientific applications of synchrotron radiation

Science context

A key mission of the ESRF involves creating novel settings of technique, instrument and local skills to promote the use of synchrotron light by non-traditional communities. This role as a catalyser and a developer will be central to maintaining the ESRF as a leading centre for high profile science with strong society benefit. This is already the case for biomedical research, environmental science and cultural heritage.

Clinical and biomedical research is continuously evolving to find new treatments and medicines for curing disease and improving quality of life. X-ray synchrotron radiation-based biomedical imaging and SAXS provide basic, clinically and industrially oriented information, which is unobtainable using any other manner. Progress made by the ESRF synchrotron radiation radiotherapy programme now makes it possible to envisage taking the next step towards clinical applications to treat currently incurable brain tumours.

The field of environmental science requires chemical and biological processes allowing the speciation, properties and behaviour of contaminants and pollutants to be understood. X-rays can provide information on specific chemical species at a very high spatial resolution that is difficult to obtain in any other way. Nanobeams are essential when investigating real samples that are extremely small (*e.g.* atmospheric particles or particles retrieved from space missions), or that exhibit very small features of interest.

Palaeontology, archaeological science and cultural heritage are topics fundamental in allowing society to understand the past. X-ray-based techniques are important methods of examining precious fossils and artefacts without destroying them to obtain valuable information on their chemical content and 3D structures at various length scales.

Added value of the Upgrade

The Upgrade Programme will play a major role in all of the emerging areas detailed above by

consolidating and developing them for use in everyday light source applications. Within the framework of the Upgrade Programme, advances will be made by:

- Developing therapeutic applications to the (pre-)clinical stage with an updated infrastructure and by potentially considering a clinical facility and application using “table-top” light sources.
- Creating a multi-technique analysis platform giving high levels of spatial resolution and detection limits for 3D imaging using microtomography and microspectroscopy.
- Building dedicated beamlines targeted at the requirements of the emerging areas with improved parallel and coherent beam imaging and linked facilities (for example, a station to scan fossils at high spatial resolution in 3D and the building of a public database).
- Developing automated customised instruments and sample environments, which allow, for example, thousands of samples to be analysed.

Key questions

The development of microanalytical techniques (microscopy, microspectroscopy, X-ray imaging) will lead to new applications allowing questions to be answered such as:

1. Which are the physical, chemical and biological mechanisms related to the cure of tumour-bearing animals treated with synchrotron radiation beams, and are they extendable to human beings?
2. What are the driving phenomena behind pollution processes involving nanoparticles (*e.g.* global dimming, ash particles, colloid transport)?
3. What are the respiration processes of bacteria growing under extreme conditions?
4. What are the degradation mechanisms leading to colour change in old paintings?

Expected user communities

The technical developments described in this chapter address communities that are not traditional synchrotron radiation users. They include the biomedical, environmental, and earth

and planetary scientists, as well as palaeontologists and the cultural heritage scientific community.

Enabling technology and infrastructure

These emerging areas will benefit strongly from the investment in new and adapted technologies and infrastructures. This will be highly beneficial.

- *Buildings and infrastructure*: Extensions for long beamlines and buildings for sample preparation and characterisation laboratories and new infrastructure.
- *Accelerator and source*: Increased flux and brilliance and insertion device flexibility.
- *Beamlines and instrumentation*: Nanofocusing optics. Adapted instrumentation and sample environments for specific applications including nanomanipulation. Fast high-energy imaging detectors.
- *Computing*: Developing computing to treat massive amounts of 3D data, with new software for data interpretation, theoretical modelling and to make beamlines user friendly. Development of software for radiotherapy treatment planning.

Partnerships

Potential partnerships exist for all of the emerging topics presented: for example, the Centre for Cancer Research, the Palaeontology Database.

Industry and technology transfer

Direct links exist to industry for the biomedical applications (contrast agents, instruments for diagnosis, ...), and indirect links for the environmental sciences, having tremendous impact on the European economy, and cultural heritage (particularly through tourism).

1.5.1. Introduction

Modern synchrotron radiation facilities are now being used by specific science communities with particular needs. Since the ESRF has adapted its techniques to the needs of palaeontologists, these scientists can now make use of the facility to carry out their research. Furthermore, others studying the emerging, high-visibility research topics of biomedical applications, environmental sciences, and cultural heritage use synchrotron radiation because it provides information that is unobtainable through other techniques. These new communities have two core requirements in common: firstly, they need an "imaging-type" approach when studying their intrinsically inhomogeneous samples; secondly, they rely on a close collaboration with the beamline scientists, essential when performing the experiments and extracting useful information from the data.

Synchrotron radiation techniques for biomedical research are used to produce key medical information but they can also have a tremendous clinical impact in several fields such as cancer, osteoporosis, arthritis and asthma. A substantial part of the work entails preclinical trials on animal models, which are necessary for preparing clinical trials (CDR: CPR), in particular those on brain tumours where no cure currently exists. Two techniques are being implemented with a view to future clinical trials: microbeam radiation therapy (MRT) and stereotactic synchrotron radiation therapy (SSRT). They both aim to destroy the tumour whilst sparing normal tissue surrounding it.

Environmental science, palaeontology, archaeology and cultural heritage are increasingly being studied at modern light source facilities. Environmental science covers a wide variety of subjects, ranging from the identification of metal contaminants and their chemical state in soil and plants to pollution remediation, nuclear waste management, and atmospheric processes such as volcanic activity, fly ash, or carbon dioxide sequestration in seas and soils. Palaeontological investigations into the inner parts of fossils (*e.g.* roots, enamel and dentine in fossil teeth) take full advantage of the coherence of the beam through phase-contrast imaging. The idea of creating a database of the most important fossils to share this knowledge with the scientific community could revolutionise the way palaeontologists work. Archaeological science and cultural heritage are not only related to the past. Indeed, as research into ancient objects provides important historical clues to investigate aspects of ancient societies, it also makes the preservation and restoration of these objects possible. The added value of the Upgrade Programme for these emerging topics lies in the fact that they share a series of technical requirements, *i.e.* high resolution ("nano") imaging as designed for the new

dedicated beamline SFINX, and improved parallel and coherent beam imaging (CDR: IMPACT). They also require a wide range of X-ray microspectroscopy capabilities, with improved spatial resolution and detection limits (CDRs: SMILE, XMAN, EDXAS), complemented by X-ray diffraction.

Many of these subjects have links with modern industry, particularly studies on contrast agents, cosmetics, oil, reduction of pollution, and waste management. They have a clear impact on the European economy, as well as on European culture and quality of life (restoration of cultural heritage, reduction of pollution, etc.). The applied and industrial aspects of this research will be fostered within the Upgrade Programme.

The new scientific communities need specific training and education to use synchrotron radiation: the ESRF (co-)finances PhD students, organises schools for "New Users", collaborates with universities, actively supports the European Course HERCULES, and participates in the organisation of HERCULES Specialised Courses.

1.5.2. Clinical and biomedical applications of synchrotron radiation

Biomedical applications of synchrotron light constitute a fast growing field of research. At the ESRF, this research comprises both basic research and clinical trials. Basic research is performed to improve understanding of the mechanisms of interaction of radiation with the tissues within a body as well as to

establish improved diagnostic and/or curative protocols, using the ideal experimental conditions offered by a synchrotron source, such as the monochromatic and collimated beam. The aim of the clinical studies is to develop innovative techniques that can be directly applied to clinical trials at synchrotron sources, and that could eventually be used with a new generation of table-top X-ray sources which are presently under development worldwide. The success of these programmes depends upon the combination of a variety of complementary research disciplines, including physics, medicine, radiobiology and oncology. The diversity of the skills available at the dedicated biomedical beamline and facility at the ESRF makes it a unique research centre worldwide.

Cellular and tissue imaging and scattering

Several biomedical imaging techniques using synchrotron light for *in vitro* and *in vivo* applications are under development. These techniques include X-ray absorption, K-edge energy and temporal subtraction, phase propagation and analyser-based imaging. They are expected to have an impact on basic, clinical and industrial research. Synchrotron radiation features such as high intensity over a broad energy range (allowing the selection of monochromatic intense beams), natural collimation, and spatial coherence are made use of to develop and optimise these novel methods.

The high-resolution visualisation and absolute quantification of drugs in tumours using the K-edge subtraction technique is a very promising and industrially important application that can be cited as an example (Figure 1.5.1). The results are used to

understand the way in which drugs target specific tissue receptors (Segers *et al.*, 2005).

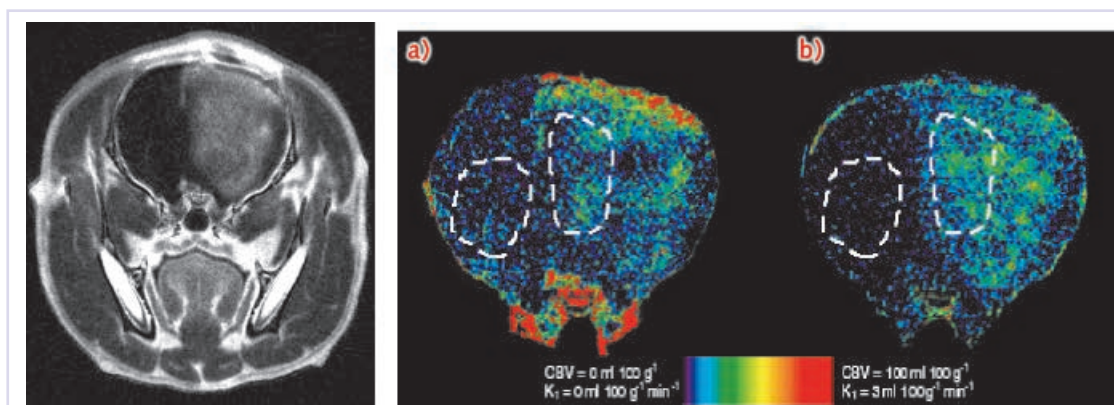

Figure 1.5.1: (Left) High resolution ($47 \times 47 \mu\text{m}^2$) synchrotron radiation computed tomography (SRCT) image after injection of a contrast agent (iodine). A time series of these images allows iodine concentration versus time to be followed quantitatively. (Right) Colour parametric maps of (a) cerebral blood volume (CBV) and (b) blood-brain barrier (BBB) permeability coefficient obtained for each pixel of time-series images. This kind of image allows the tumour development to be understood and the effects of the applied therapies to be evaluated. This multidisciplinary research involving biological, medical, and physics expertise will greatly benefit from the new and improved techniques and support laboratories that will be developed within the Upgrade Programme. An example of a new development would be following nanoparticles injected into cells using *in vitro* experiments with soft X-rays (CDRs: SFINX, SMILE, IMPACT), which will then allow *in vivo* preclinical experiments (CDR: CPR) to be refined in order to improve photon activation therapeutic assays.

Synchrotron-based microcomputed tomography (μ CT) offers new prospects for preclinical research. It will permit a full three-dimensional characterisation of the cortical microvascular organisation in the brains. This is very important for our understanding of a broad range of biological subjects, which include normal and pathological vascular development, functional imaging and therapeutic strategies (Risser *et al.*, 2007). Osteoporosis is another important subject: it is a bone fragility disease that is increasing due to aging of the population. Understanding the factors that determine bone quality will help to explain and predict the risk of fracture. Synchrotron μ CT allows simultaneous investigation of the micro-architecture, bone mineralisation and mechanical behaviour in 3D (Chappard *et al.*, 2006). Imaging the microvascular bone network at the sub-micrometre scale will make it possible to understand the response of micro-vascularisation to physiological or pathological stimuli that regulate bone modelling, and to study the effect of drugs. A 3D analysis of this kind, combined with spatially-resolved XANES spectroscopy, will lead to micro-quantification of the elements involved in bone growth such as calcium and potassium.

SAXS is increasingly being used to provide physiologically relevant structural information from tissues. The molecular basis of muscle function can be assessed by studying motor proteins such as myosin II, which gives information on the kinetic and mechanical features of the molecular motor. This structural information is extremely useful when studying the pathophysiological effects of an illness such as tetanus. Similar SAXS investigations are being extended to axonal membranes in nerves for a better understanding of the ionic mechanisms underlying propagation of the nerve conduction signal. Changes in the SAXS pattern of collagen from different kinds of tissues such as breast

and bone can be correlated with the presence of cancer cells and other pathological signs in histological slices of the specimen, so that the specimen can be mapped for malignancy.

The development of clinically-oriented techniques at the ESRF, such as analyser-based imaging (ABI) for osteoarthritis (see [Figure 1.5.2](#)) and phase-contrast high-resolution mammography (Bravin *et al.*, 2007), can lead to an actual clinical application through collaborative programmes with hospitals and industry. The clinical applications will eventually be performed using table-top monochromatic sources, which are presently under development around the world.

Effects of radiation on cells and tissues

In parallel with clinically oriented research, synchrotron radiation is being used increasingly to study fundamental radiobiology and radio-oncology scientific cases, in particular, the interaction mechanisms of radiation with cells and tissues. An example of this type of study can be found in the biochemical process related to the selective efficiency of radiotherapy on cancerous versus normal tissues (Mooney, 2005). This is of general interest in clinical cancer research.

Several secondary effects can occur after high-dose brain irradiation, including demyelination, vascular damage, dementia and white matter radionecrosis. Such lesions are likely to be the main cause of cognitive dysfunction observed after conventional cerebral tumour radiation treatment with high cumulative doses. *In vitro* and *in vivo* tissue damage and repair can be studied using microbeams. Serduc *et al.* (2006) have determined the time course of the effect of radiation on brain microvasculature for various delivered doses ([Figure 1.5.3](#)) whilst Blattmann *et al.* (2005) have observed the formation of vascular bridges across areas situated directly in the path of a microbeam. These processes, together with the "bystander" effect (indirect communication between cells), are state-of-the-art biomedical research topics. They can be combined with theoretical simulations on DNA damage for a detailed understanding of the cellular response to radiation.

Other examples of promising research that have already been initiated include apoptosis (programmed cell death), DNA reparation channels following radiation damage and the synergy of radiotherapy and chemotherapy. A better understanding of all of these processes will mean that information of critical importance can be obtained by both in-

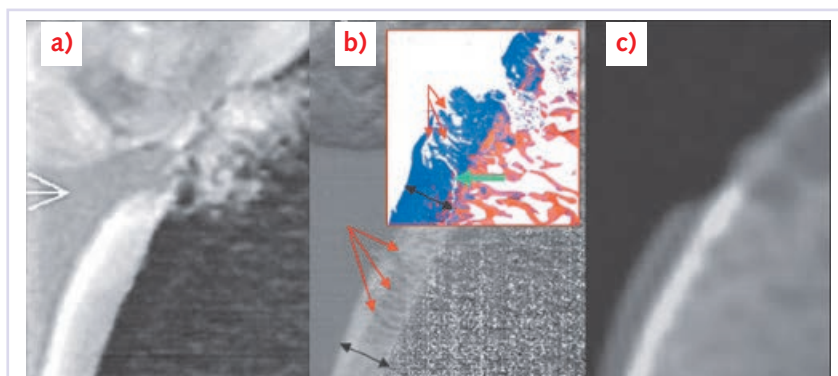

Figure 1.5.2: Observation of cartilage using three different imaging techniques: a) MRI, b) ABI, with a corresponding biopsy in the inset, and c) X-ray absorption. The damage to the cartilage is only observable non-invasively on the ABI image. Developing ABI is important for osteoarthritis diagnosis. In future, this research will be performed *in vivo* with the aim of testing the reconstruction of damaged tissues associated with new pharmaceutical drugs targeting osteoarthritis. The Upgrade Programme will permit laboratories in the Biomedical Facility to be equipped specifically for this research.

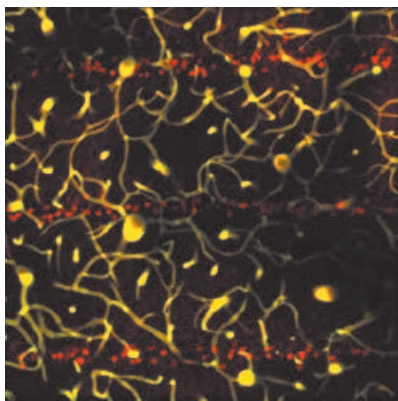

Figure 1.5.3: Normal cortical microvascular network of a mouse, 48 h after a 1000 Gy microbeam exposure (microbeam spacing: 211 μm , microbeam width 25 μm). The three red dotted parallel lines correspond to dye extravasation through the damaged blood vessels and fixation in the dying brain cells situated in the microbeam paths. This research, closely related to the MRT technique, can only be performed at a synchrotron light source. Within the Upgrade Programme, the increase in the machine current will be beneficial, as will the refurbishment of the biomedical beamline (CPR), which will be suitable for testing the therapy in large animals.

house developed radiotherapy programmes (MRT and SSRT) and in clinics.

The genetic and molecular biological mechanisms related to cell radioresistance are also being studied for *Deinococcus radiodurans*, a particular, non-pathogenic, bacterium able to withstand up to 10 kGy of ionising radiation. Its resistance is thought to be a side effect of mechanisms designed to allow the bacterium to survive during extended periods of desiccation. This research also has important knock-on effects concerning the bioremediation of sites contaminated with radiation and toxic chemicals. Studies are planned at the ESRF to understand the role of specific proteins in DNA protection and repair (Zahradka *et al.*, 2006).

A multidisciplinary approach to the subject is necessary to fully interpret the biochemical data, thereby understanding its origin. In this way, the radioresistance of the cells can best be exploited. The ESRF Upgrade Programme will open up new research pathways including the analysis of morphological changes of cells irradiated with nanometre-sized beams (see imaging in CDR IMPACT) and the localisation and quantification of metals using higher sensitivity fluorescence techniques (CDR: SFINX).

Preclinical and clinical radiotherapy studies

The ESRF is a pioneer of synchrotron radiation radiotherapy applications. Thanks to several key collaborations with groups of neuro-oncologists,

pathologists and biologists, since the late 1990s, the research has focused on the use of spatially fractionated X-ray beams, delivered in extremely high doses (several hundreds of Grays) to treat aggressive non-treatable brain tumours. The principle of microbeam radiation therapy (MRT) as a potential alternative to radiotherapy lies, on the one hand, in the destruction of the vascularisation of the tumour and, on the other hand, in the high normal tissue tolerance of such microbeams. It has now been proven that normal tissues can repair the damage, unlike those affected by tumours. Preclinical research studies have demonstrated the ability of MRT to cure a significant number of rodents without side effects. This therapeutic protocol is being improved by combining the X-ray treatment with stimulation of the immune response (Smilowitz *et al.*, 2006).

Stereotactic synchrotron radiation therapy (SSRT), which has been developed at the ESRF, is a complementary research programme aimed at treating brain tumours. SSRT involves loading the tumour with a high atomic number element, associated either with or without a chemotherapeutic drug, and then irradiating the target with monochromatic X-rays. The tumour is placed at the centre of rotation and the radiation is delivered in tomographic mode: the patient is rotated in the beampath in such a way that the normal tissues surrounding the tumour receive only a small fraction of the X-ray dose. For rats bearing highly aggressive tumours, a very significant extension of life span was observed for SSRT-treated animals previously inoculated with iodinated compounds. An important fraction of animals were cured when SSRT was performed with high atomic number elements associated with chemotherapeutic drugs (Biston *et al.*, 2004). The combination of MRT X-ray treatment and a local dose enhancer has recently given a significant increase in animal survival rate.

Preclinical MRT and SSRT experiments have already provided results that will pave the way for clinical trials at the ESRF. The long delay before clinical application is typical for biomedical research: the effects of a single protocol under test can be seen only months after the treatment and dozens of biological and physical parameters must be tuned, which involves contribution from a broad spectrum of expertise. Today, the ESRF is the only synchrotron radiation facility in the world where clinical trials in radiotherapy are possible. This is thanks to the presence on the same site of a beamline with adequate spectrum and X-ray fluency and the biomedical infrastructure, as well as extensive collaboration between the beamline staff and hospital teams.

Relevant Conceptual Design Reports:

- CPR: Development of Clinical Protocols in Radiotherapy
- IMPACT: Imaging using Parallel Beam and

Computed Tomography

- SAXS: Small Angle X-ray Scattering
- SFINX: Scanning Fluorescence and Imaging at the Nanoscale using X-rays
- SMILE: Spectro-Microscopy and Imaging at Low Energies
- XMAN: X-Ray Spectroscopy Multi-Imaging Analysis

Key enabling technologies and infrastructures:

- Detectors: Developments of fast and high resolution 2D imaging detectors for high (>30 keV) energies.
- Buildings: Refurbishment as described in the CDR CPR for clinical trials in human beings. Construction of a second experimental hutch to use the beam time more effectively.
- Infrastructure: Expansion of the biomedical facility laboratories for cell and tissue preparation and analysis and for preclinical experimentation.

1.5.3. Environmental science

Environmental science incorporates the study of biodiversity, groundwater and soil contamination, use of natural resources, waste management, sustainable development, air pollution and climate change. To better understand the chemical and biological processes affecting the speciation, properties and behaviour of contaminants, pollutants, and nutrients in the ecosphere (SLAC, 2003), it is becoming increasingly important to obtain information at the molecular level. Synchrotron radiation techniques enable the study of aqueous solute complexes, poorly crystalline materials, solid-liquid interfaces, mineral-aqueous solution interactions, microbial biofilm-heavy metal interactions, heavy metal-plant interactions, complex material microstructures, and nanomaterials. These are all important environmental components or processes. The increasing demand for these studies necessitates increasing the number of microprobe and imaging facilities at synchrotron light sources.

The inherent interdisciplinary nature of environmental science means that crosslinks and overlap exist with other chapters (chapters 1.1, 1.2 and 1.3) and they are easily recognisable. The selected examples aim at illustrating the anticipated evolution towards *in situ* quantitative measurements with high spatial and temporal resolution, which can only be carried out using a combination of different techniques. Therefore, access to the full range of techniques offered by the Upgrade Programme will be key to the success of many studies.

Pollution and remediation processes

Throughout the ages, human societies have modified the original form of metals and metalloids in their

living environment for both their survival and technical development. In many cases, these anthropogenic activities have resulted in the release of contaminants into the environment that pose a threat to ecosystems and public health. These anthropogenic metals are primarily released into the environment through the soil (Figure 1.5.4). The toxicity of these elements generally depends on their solubility: the less soluble a chemical species, the less mobile and less toxic it is. The potential human and ecological impact of hazardous heavy metals can therefore be reduced by transforming soluble species to sparingly soluble forms, either *in situ* or in landfills after excavation. In the long-term, researchers aim to understand and control the form of metal contaminants in the environment.

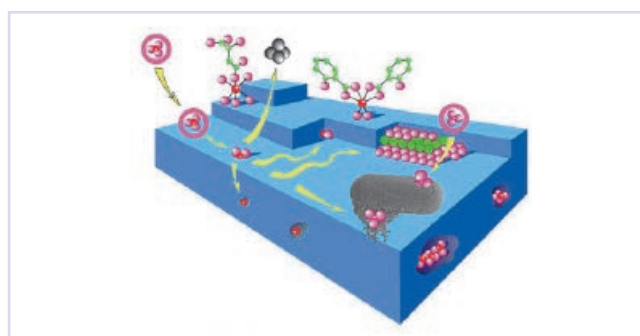

Figure 1.5.4: Basic processes of adsorbate molecules or atoms at the mineral-water interface. Understanding these processes by studying their chemistry and structure is central to improving remediation of contaminated material. The Upgrade Programme will develop a multi-disciplinary platform to analyse samples at high spatial resolution combined with elemental mapping and speciation. *In situ* and real-time studies, as well as sample preparation laboratories, will also play a crucial role.

Deciphering the crystal chemistry of trace metal(oids) in the environment is difficult due to the heterogeneity and complexity of natural materials in both composition and structure. The integrated approach involves the synergetic use of three microanalytical techniques. μ XRF is first used to map elemental distributions and identify elemental associations. The nature of the host phases at points of interest on chemical maps is then deduced from μ XRD and μ XANES spectroscopy. The proportion of each species in the bulk is determined by reconstructing the spectrum with a linear combination of component species spectra from μ XANES data (Manceau *et al.*, 2002). Future additional kinetic studies of chemical reactions *in situ* at mineral and microbial surfaces and in the rhizosphere of plant roots in soils (including real-time studies of redox transformations of environmental pollutants by energy-dispersive EXAFS and μ XANES) are also being envisaged.

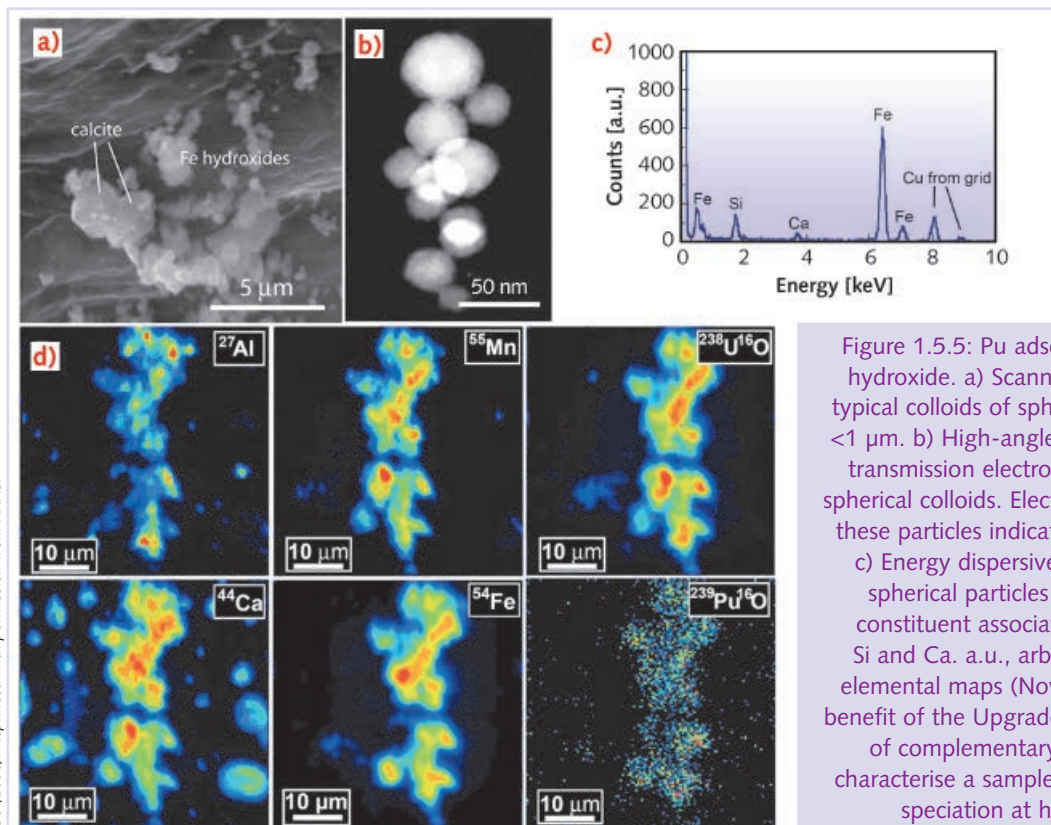

Figure 1.5.5: Pu adsorption onto amorphous Fe hydroxide. a) Scanning electron micrograph of typical colloids of spherical particles with a size of $<1\ \mu\text{m}$. b) High-angle annular dark-field scanning transmission electron microscopy image of the spherical colloids. Electron diffraction patterns from these particles indicate that they are amorphous. c) Energy dispersive X-ray spectrum from the spherical particles shows that Fe is a major constituent associated with trace amounts of Si and Ca. a.u., arbitrary units. d) Nano-SIMS elemental maps (Novikov *et al.*, 2006). The key benefit of the Upgrade Programme is to offer a set of complementary techniques able to fully characterise a sample with element mapping and speciation at high spatial resolution.

Studying even smaller objects is also becoming increasingly important. Nanoscale earth and environmental materials play a major role in interfacial chemical reactions and enormous quantities of nanometre-scale particles occur in natural waters, aquifers, soils, sediments, mine tailings, industrial effluents, and the atmosphere. As outlined in [chapter 1.1](#), there is also growing evidence that the structure and properties of nanoparticles change as particle size decreases. The new infrastructure (beamlines and associated laboratories) proposed in the Upgrade Programme will make a very attractive and unique analytical platform available to study nanoscale pollutant particles. The key benefit of the platform is the integrated set of techniques able to fully characterise a sample with element mapping and speciation at high spatial resolution. For example, submicrometre-sized mobile colloids are known to occur naturally in groundwater and have the potential to enhance the transport of non-soluble contaminants through complex sorption mechanisms. The possible implications of this transport mechanism are of particular concern in the context of radionuclide transport. The formation of actinide pseudo-colloids, in which the actinide sorbs onto aquatic colloids, can stabilise actinides in natural waters and increase their concentrations by many orders of magnitude over the values expected from solubility calculations.

For instance, significant quantities of the element plutonium have been introduced into the environment as a result of nuclear weapons testing and production, and nuclear power-plant accidents (Kersting *et al.*, 1999).

Moreover, many countries anticipate storing nuclear waste underground. Many previous studies have experimentally demonstrated adsorption of Pu onto a variety of minerals and mineral assemblages. However, little is known of the speciation of the actinides or the type of colloids with which they are associated, particularly during transport in the far-field where there are many competing processes, such as desorption from the colloids and resorption onto minerals (Novikov *et al.*, 2006) ([Figure 1.5.5](#)).

Remediation processes can arise from both natural and man-made sources. Many microorganisms and plants are capable of transforming toxic chemical species into less toxic forms. Some plants are particularly useful for remediation of contaminants in soils and water because they hyper-accumulate specific toxins. When μXRF (Harada *et al.*, 2006) was used, chemical images of small trichomes on plant leaves revealed that cadmium accumulated in these epidermal hairs and is found at places enriched with calcium. However, in the majority of cases, the molecular scale mechanisms of these transformations or of hyper-accumulation are not known and more studies are needed to develop this green technology efficiently.

The study of nanofluids is another fascinating potential research field and these suspensions of nanometre-sized particles are used in a variety of technological applications. Their spreading and adhesion behaviour on solid surfaces can yield materials with desirable structural and optical

properties. Similarly, the spreading behaviour of these nanofluids may influence soil remediation, oily soil removal and enhanced oil recovery. Studies using synchrotron radiation on the two-dimensional ordering of those charged nanometre-sized particles in water are therefore needed in the long term in order to obtain concrete results in the field.

Nuclear waste management is an area of increasing importance. Zircon has been proposed as a material to immobilise the plutonium isotope over geological timescales. Zircon is a ubiquitous mineral with high chemical durability in the Earth's crust. Damage studies after α -decay have provided vital information required for assessing the durability of zircon and to study possible development strategies for the safe encapsulation of actinides in zircon. Different methods are needed depending on the concentration of pollutant. At the highest concentrations, when the material is fully amorphous, XAS must be used to investigate the geometry of its nearest neighbours. However, until recently, only NMR, XRD and other table-top methods have been applied (Farnan *et al.*, 2007). A high potential for synchrotron-based techniques therefore exists in this field. For example, good nuclear waste management requires a profound understanding of the geochemical behaviour of sulphur in the treatment of vitreous waste material from refuse incineration activities. The ongoing research project at ID26 on sulphur in glasses is an example of the fact that the combination of XANES, $K\alpha$ and $K\beta$ emission spectroscopy provides unique information on the oxidation state, structure, ligand chemistry and first ligands. The Upgrade Programme, through its development of beamlines with complementary spectroscopic techniques, is expected to provide exciting new research opportunities in this field of science.

Atmospheric processes

Understanding how the atmosphere works is fundamental to understanding climate change. For example, aerosol (nano)particles have the potential to form cloud condensation nuclei, thus affecting cloud formation as well as the global radiation budget. Volcanic gas emissions (mainly sulphur) influence the circulation and backscattering of solar radiation through the formation of sulphate aerosols and thus further contributing to global warming. Synchrotron radiation techniques can be used to address scientific issues in many areas. These topics are explored below.

Nanometre-sized aerosol particles are considered to be the likely cause of a variety of congenital diseases, as well as being contributing factors to global warming and the degradation of environmental quality. The ultra-fine nanoparticles can only be removed with great difficulty and represent a severe

health threat because the toxic waste can easily be transported through the cell membrane to sensitive body organs. Advances have been made in the field of clean diesel technology, however, current regulations mainly apply to the overall mass content of carbon at the exhaust streams and control over nanoparticulate pollution has been conveniently ignored. Moreover, it has been demonstrated that the amount of ultra-fine nanoparticles increases dramatically with particle traps on heavy duty diesel exhausts, whilst the cosmetic larger particles are filtered off. Diesel soot consists typically of primary particles, plus their aggregates and agglomerates. Matching these structures to the type of source and conditions under which they are formed (fuel, engine speed, temperature, acceleration/deceleration, etc.) will be helpful in controlling the particulate pollutants, thereby reducing the risks they represent. Synchrotron SAXS offers a unique tool for *in situ* characterisation of ultra-fine nanoparticles from airborne (sub-ppm level) to concentrated filtrates. Unlike other commonly used techniques, SAXS is the only technique whereby it is possible to elucidate particle size, polydispersity, number density, aggregate size, fractal dimension and degree of aggregation without influencing source conditions (Beaucage *et al.*, 2004). These structural parameters will allow the nanoparticulate pollutants to be fingerprinted. In addition, SAXS techniques allow the growth dynamics of such nanostructures in the exhaust stream to be studied on the millisecond scale.

Waste fly ash is created during the combustion process in power plants. It consists of fine particles containing potentially toxic trace metals, which cause environmental problems related to air and water pollution. Precise quantitative reconstruction of the internal elemental composition and structure of single waste fly ash (Figure 1.5.6) using 3D combined XRD-Compton-transmission tomography (Pinzani *et al.*, 2002) is crucial if an intelligent ash management system is to be developed.

Volcanic gases carried by magmas (either dissolved or exsolved), have a fundamental effect on a variety of geological phenomena, such as magma dynamics and the composition of the Earth's atmosphere. These gases trigger volcanic eruptions and are therefore used for eruption prediction. Nonetheless, the redox state of erupted magmas should not necessarily be used as a comparative base for the redox state of the gases they emit (Burgisser and Scaillet, 2007). Sulphur incorporated in inclusions (Guilhaumou *et al.*, 2005) or in silicate glasses (Metrich *et al.*, 2006) has been investigated by microanalysis techniques. This is of utmost importance because they are considered as the frozen picture of their molten counterparts. *In situ* measurements are also essential in revealing the factors affecting the geochemical behaviour of sulphur in magmas.

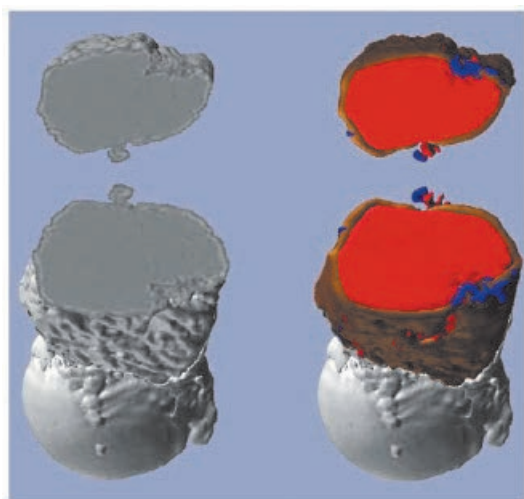

Figure 1.5.6: 3D rendering of conventional transmission tomography (left) and of the distribution (right) of rubidium (red), manganese (brown) and iron (blue) in a fly ash particle (Goloso *et al.*, 2004). The higher spatial resolution and sensitivity resulting from the Upgrade (smaller beams, greater stability, improved detectors) will allow a greater level of detail to be recorded from objects such as this.

Carbon dioxide sequestration in soils and oceans is an extremely important subject for our society. Research on carbon dioxide capture and sequestration needs to be carried out to determine whether the energy costs can be brought down to an acceptable level (Broecker, 2007). The current rise in atmospheric carbon dioxide can partly be reduced by carbon sequestration within forest ecosystems, if carbon can be stored in vegetation or soils. A better understanding of carbon cycling in forest soils is needed in order to evaluate the role of soils as long-term carbon sinks. Combined μ XRD and μ XANES are the techniques that are best adapted to study the role of trace metal availability in photosynthetic carbon fixation, an issue which needs to be addressed in the future.

Another key scientific unknown about climate change is the effect of the take-up of carbon dioxide by the oceans, which removes the gas from the atmosphere and locks it away in the calcium carbonate of the shells and skeletons of marine organisms. Trace metals (iron and zinc) in the atmospheric dust deposited into the ocean further affect the biogenic calcification. Consequently, there is a high potential for synchrotron-based techniques in this field. The Upgrade Programme will provide a methodological and instrumental development programme taking into account the needs of this research area.

Past climate and proxies

The contribution of our anthropogenic influence on the natural pattern of global environmental changes is fundamental for predictive models. The study of past climatic changes is also extremely important in

obtaining information on natural variability, achieved by examining natural geological and biological archives. Making it possible to obtain accurate ages for the proxy data series, possibly at the annual to sub-annual scale is crucial. Several recent experiments have confirmed the potential of microanalytical techniques to study proxies such as speleothems (Frisia *et al.*, 2005) (Figure 1.5.7), polar ice (De Angelis *et al.*, 2004) or biominerals (Cuif *et al.*, 2003).

Corals show seasonal growth layers and provide a unique record of environmental changes in the oceans. They incorporate key trace elements in approximate proportion to seawater concentration, and can be dated directly using both high precision U/Th and ^{14}C methods. Corals have been extensively used to reconstruct environmental variability in the tropical region (Montagna *et al.*, 2006). Their potential as environmental archives has just been recognised for the extra-tropical regions. Several European programmes, funded both by ESF and EU networks, have recently been devoted to the identification of new climate archives for the Mediterranean Sea. Coral physiology controls occur within the growing carbonate skeleton, and skeletogenesis thus occurs in a "biologically-controlled medium". This process is responsible for significant geochemical differences at the sub-micrometre scale that may be superimposed onto environmental signals. Such fine-scale variability can only be detected and investigated by using highly resolved analytical techniques with very low background and low detection limits, such as those based on synchrotron light. It is only by combining several

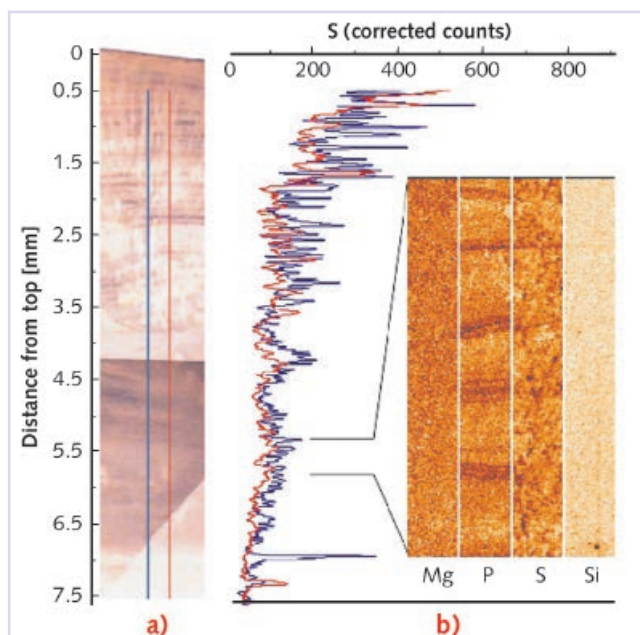

Figure 1.5.7: X-ray microfluorescence of a stalagmite wafer (timescale 155 years between 1840 to 1995 AD) and maps of four trace elements ($60 \times 500 \mu\text{m}^2$). The micro/nano-analytical techniques of the Upgrade Programme will offer the precision and resolution needed to tease accurate information out of samples such as the stalagmite wafer.

microanalytical methods such as 3D-XRF, XANES and microdiffraction that a full picture of this problem can be appreciated. The Upgrade Programme nanoprobe and nano-imaging beamlines will be unique tools for structural, compositional and chemical investigations.

Life under extreme conditions

"Extremophile research is entering an exciting phase. Our ignorance of microbial diversity coupled with improvements in exploration and analytical technology suggest that many more major discoveries will be forthcoming" (Rothschild and Mancinelli, 2001).

The microbial life that thrives under extreme environments, has certain physiological and nutritional adaptations which allow them to thrive in harsh physical (*e.g.* temperature, radiation or pressure) or geochemical (*e.g.* desiccation, salinity, pH, oxygen species or redox potential) conditions. Studies on extremophilic organisms have intensified in the last decade due to their appeal both as models of primitive life forms and as sources of outstanding biomolecules, useful in fundamental and applied research. The energy metabolism of prokaryotes under extreme conditions is, for example, based upon a wide range of oxidation-reduction reactions involving metallic compounds. The understanding of these respiration processes is hampered by the lack of direct access to *in vivo* processes. When investigating extreme habitats, their remote nature, harsh conditions and inaccessibility must be taken into account. Diamond anvil cell (DAC) technology has been successfully associated with Raman spectroscopy. This combination shows real scientific potential for new methodologies to study extremophile metabolism. A dedicated part of the Upgrade Programme, including the development of a DAC to simulate extreme conditions in terms of temperature, metal concentrations and anaerobiosis, will exploit the unique capabilities of X-ray microspectroscopy in terms of lateral resolution, detection limit and chemical information. Monitoring redox reactions at the level of a single organism can be envisioned. Access to the absorption edges of sulphur and metals together with FTIR microspectroscopy offers a unique experimental setup in this field of research.

Extremophilic organisms are another example of endolithic microbial communities. The endolithic environment, *i.e.* the pore space of rocks, is a ubiquitous habitat for the Earth's microorganisms and important in studies towards the search for life elsewhere in the solar system. Photosynthetic, endolithic microbial communities commonly inhabit the outer millimetres to centimetres of all rocks exposed to the Earth's surface. The identification and study of these microbial communities, which often live under extreme conditions (for example, the extremely acidic geothermal environment of Yellowstone National Park, USA (Walker *et al.*, 2005)) are essential in understanding the corrosion of rocks.

They can also serve as ways of providing important clues about geothermal environments in ancient times. To date, this has never been investigated using synchrotron-based techniques. The ESRF is expected to play a central role in this topic thanks to its long-standing experience in extreme conditions-related science and its future ambitious programme on the developments of specific sample environments.

Relevant Conceptual Design Reports:

- EDXAS-L: Energy Dispersive Absorption Spectroscopy (large spot)
- EDXAS-S: Energy Dispersive Absorption Spectroscopy (small spot)
- SAXS: Small Angle X-ray Scattering
- SFINX: Scanning Fluorescence and Imaging at the Nanoscale using X-rays
- SMILE: Spectro-Microscopy and Imaging at Low Energies
- XAS-XES: Steady-State and Time-Resolved X-ray Absorption and Emission Spectroscopy
- XMAN: X-ray Spectroscopy Multi-Imaging Analysis

Key enabling technologies and infrastructures:

- Detectors: Developments of 2D imaging detectors and high collection and high spectral resolution energy/wavelength dispersive systems.
- Sample environments: this programme will rely on the development of specific *in situ* cells.
- Data analysis and computer support.

1.5.4. Palaeontology

The aim of palaeontologists is to study the external morphology of fossils and, increasingly, to have access to the internal structures and 3D organisation of the samples. Fossils are a non-renewable resource. Techniques are required that avoid cutting them and allow studying their internal structures. Non-invasive X-ray imaging techniques are ideal for such investigations. In spite of important developments, microtomographs using conventional X-ray sources are unable to generate useful data on numerous fossils. Indeed, the fossilisation process often leads to strong mineralisation and chemical modifications. The structures of the original organism can be masked by this fossilisation process and they become barely distinguishable or even invisible when using conventional X-ray imaging equipment.

Synchrotron radiation imaging of palaeontological samples has developed dramatically at the ESRF (Tafforeau *et al.*, 2006) since the first experiment performed on fossil teeth (Chaimanee *et al.*, 2003). The monochromaticity, high intensity, parallel geometry and coherence, leading to phase-contrast imaging, of the ESRF X-ray beams make it possible to reveal the

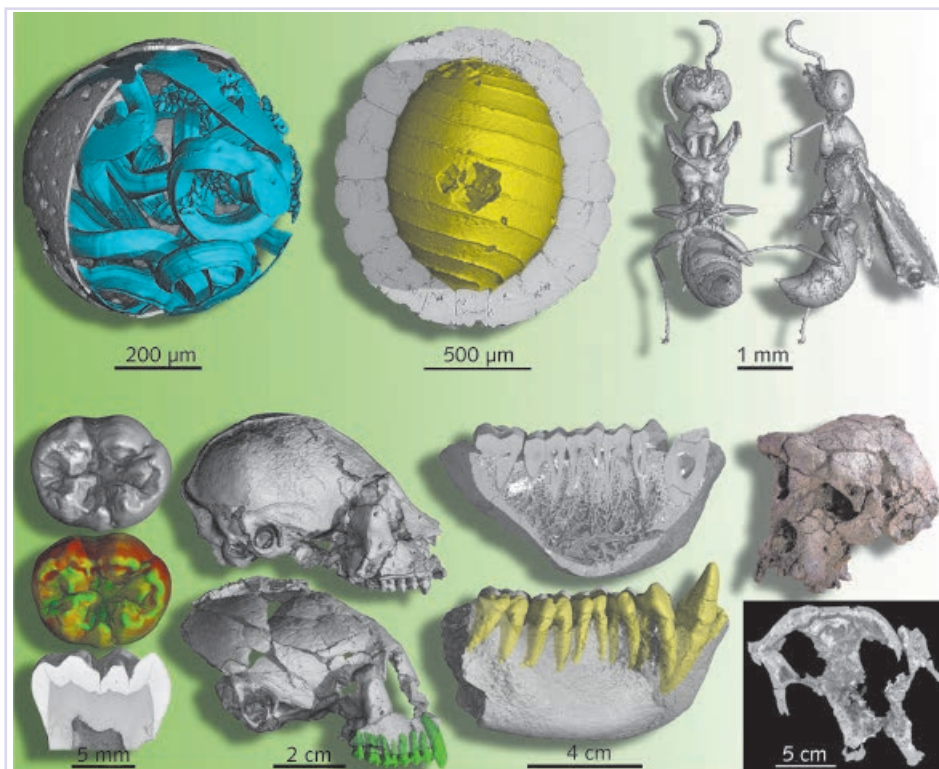

Figure 1.5.8: Examples of fossil imaging at the ESRF illustrating the vast range in shape and size. From top left to bottom right: 0.28 μm , 580 My enigmatic embryo from China. 1.4 μm , 90 My charophyte algae *Peckisphaera gigantea* from France. 5 μm , 100 My wasp in amber from France. 16 μm , 20 Ky *Homo sapiens* molar from South Africa. 45 μm , 17 My primate skulls of *Homunculus patagonicus* from Argentina. 45 μm , 7 My Hominoid mandible of *Khoratpithecus piriyai* from Thailand. 45 μm , 7 My Hominid skull of *Sahelanthropus tchadensis* (Toumai) from Chad. A CDR (IMPACT) of the Upgrade Programme includes an end station partly dedicated to the scanning of thousands of fossils at this resolution with the results to be made publicly available. Such work is only possible at a high-energy source such as the ESRF.

3D fossil structures with a degree of accuracy that has never previously been obtained. This opens up new possibilities for non-destructive study.

Fossils are part of human heritage and, as such, it is as important to study them as it is to preserve them. The ESRF currently acts as the world leader for non-destructive investigations of fossils, by providing the highest quality data, and helping to preserve them. The Upgrade Programme intends to catalyse the evolution of X-ray imaging techniques at the ESRF through the development of both improved and wholly new facilities (see CDRs: **IMPACT**, **SFINX**, **HIENE**). Most of these new developments will be applied to fossils so that an increasing number of non-destructive investigations become possible. Furthermore, the ESRF could become a central point in distributing knowledge through a free access database containing the scans of the published fossils. Imaging techniques already produce massive quantities of data which will increase with the improved spatial resolutions resulting from the Upgrade. The fossil programme will create data that should be publicly accessible. The Upgrade developments in online/batch data analysis and data archiving and curation will therefore be critical to the success of the enhanced imaging facilities and will produce a virtual data library.

Synchrotron imaging of fossils: state-of-the-art and evolution

Fossils for synchrotron imaging come in a range of sizes that start at less than 500 μm and go up to more than 20 cm. To provide a corresponding range of resolutions and fields of view, different beamlines

should be used. It is worth emphasising the importance of the large field of view and the high-energy beams, coupled with phase contrast, for imaging many important fossils. The origins and ages of the fossils (from 580 million years (My) to nearly modern) can also vary greatly (Figure 1.5.8).

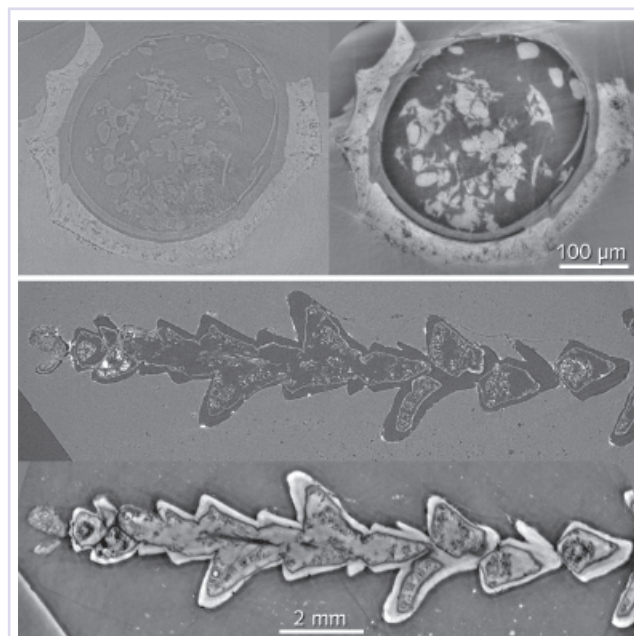

Figure 1.5.9: (upper) A comparison between absorption (left) and holotomography (right) on a 30 My old charophyte algae preserved in mineral matrix. Holotomography revealed that some organic matter was still present. (lower) Comparison between absorption (top) and holotomography (bottom) on a 100 My old conifer branch preserved in opaque amber. Holotomography offers far better contrast than absorption.

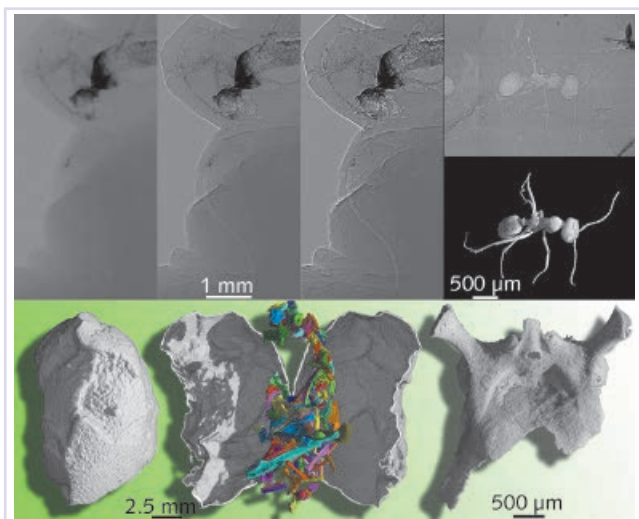

Figure 1.5.10: (upper) The effect of propagation phase contrast on 100 My old insects in amber from France on radiography and microtomography. Both specimens are ants imaged with a pixel size of 5 micrometres. (lower) A tiny Cretaceous egg from Thailand with a preserved embryo skeleton imaged by propagation phase-contrast microtomography with a 16 μm pixel size. The bones are invisible in absorption mode. The single bone on the left (basisphenoid) illustrates the result of a 5 μm voxel size scan on that egg.

The high mineralisation of many fossils prevents clear absorption contrast when imaging. Propagation phase-contrast imaging can reveal structures that are invisible in absorption, such as the structures of fossil plants in opaque amber shown in the examples in Figure 1.5.9. Palaeontological research takes full advantage of all of the improvements carried out on synchrotron-based X-ray imaging techniques. Holotomography, for example, was initially developed to reconstruct quantitative phase information on nearly pure phase objects. It is now being adapted to fossils, which are, in the majority of cases, highly absorbing, and give impressive results (Figure 1.5.10). New developments of this technique will make it a reference tool for the high-quality non-destructive imaging of fossils.

When applied to fossil teeth, propagation phase contrast imaging can reveal incremental features (Brunet *et al.*, 2005, Chen *et al.*, 2006). Non-

destructive investigations of dental development and life history of fossil primates, especially hominoids and hominids (Smith *et al.*, 2007), could follow. Until now, it was only possible to investigate isolated teeth using this technique. Evolution of the technique (with high-energy X-ray images, retaining the sub-micrometre resolution, and recorded under "local tomography" conditions) is necessary in order to reach the microscopic level on more complete samples such as mandibles or maxillas.

If the fossil organisms have been compressed by several hundreds of metres of sediments, they are preserved on large flat plates of rock. Numerous examples of "flat" fossils exist. Laterally-extended samples are extremely difficult to image using microtomography because they absorb the totality of the X-rays along their longest dimension. As far as these fossils are concerned, an alternative technique, laminography, initially developed to image electronic devices, is able to provide high-quality pictures. This has been proven by feasibility tests that revealed the internal anatomy of a flat fossil insect on a calcareous plate in great detail (Figure 1.5.11). This is an exciting result since many of the most important specimens are flat, as are most of the fossils containing preserved soft body parts.

Whereas a substantial part of the scientific case resides in fossils requiring very high spatial resolution, it appears that synchrotron imaging of palaeontological samples is not restricted to small objects requiring a very high spatial resolution: the image quality and the observable details on large fossils scanned at the ESRF are superior to anything obtained with laboratory $\mu\text{-CT}$ instruments (Figure 1.5.12), allowing extraction of scientific information otherwise not observable. To quote an example, the Toumaï skull was scanned in its entirety with a resolution of 45 micrometres (Figure 1.5.8).

Conservation and sharing of the human palaeontological heritage

The exceptional data provided by synchrotron radiation imaging should be available to the whole palaeontological community. Indeed, high quality

Figure 1.5.11: Results of tests of laminography on a flat fossil insect from Brazil. Left: photograph of the original fossil. Right: laminographic slices at different depths in the fossil revealing the internal structures and legs that were invisible in the original fossil (voxel size 7.5 μm).

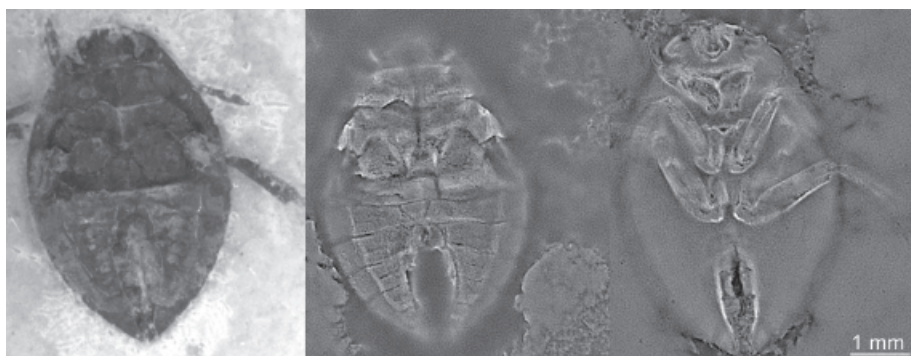

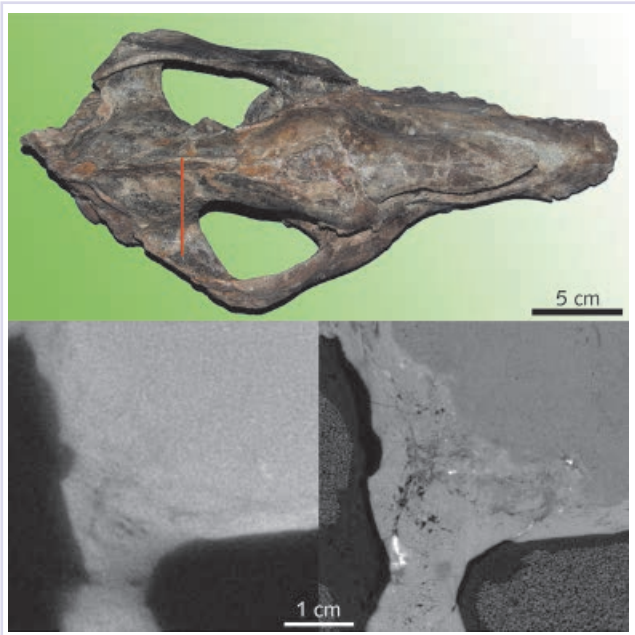

Figure 1.5.12: Synchrotron radiation microtomography on a large fossil *Paleotherium* skull from France (top). The comparison between a high-energy industrial scanner located at INSA-Lyon (bottom left; voxel size 127 μm ; X-ray generator 400 kV) and a scan performed at the ESRF on beamline ID17 (bottom right; voxel size 90 μm ; 90 keV). The contrast is far higher in the slice from the ESRF because of monochromaticity and relatively lower energy.

numerical data are not only an effective way of studying internal anatomy and structures of fossils, but they also make it possible to share important fossil information across the community. The ESRF could develop a free access database with all of the important fossils scanned and published online. This database would allow other scientists to study and/or print a given fossil in 3D, and make important comparative studies possible. This database is also a way of preserving fossils by reducing the number of manipulations and casts and also by limiting the movement of important specimens, as all these operations can degrade fossils.

The main limitation for the constitution of such a database would be access to beam time, especially for large projects such as scanning the South African hominid fossil collections. The work involved in scanning many (up to thousands) fossils cannot just be added to the already overloaded imaging beamlines. A new end station providing a large field of view and high energy and included within the IMPACT CDR, will be partially devoted to palaeontology to help build this important database.

Therefore, the ESRF can generate high quality data on a large variety of fossils and also initiate palaeontological data sharing. Making "virtual fossils" widely available would contribute to both fossil preservation and the diffusion of knowledge in the palaeontology field.

Relevant Conceptual Design Reports:

- IMPACT: Imaging using Parallel Beam and Computed Tomography

Key enabling technologies and infrastructures:

- Detectors: Development of fast and high resolution imaging detectors for high (>30 keV) energies
- Upgraded beamline with two canted insertion devices and a second patch for high energy, high quality, large images (see CDR IMPACT)

1.5.5. Archaeological science and cultural heritage

Archaeological science or archaeometry was originally a term that referred to the use of physical measurements in archaeology. Nowadays, it is more broadly defined as the application of the physical, chemical, biological, medical and engineering sciences to archaeology. The archaeological community has only recently started to become interested in synchrotron radiation and now this demand is ever increasing. Over the past five years, the number of publications has increased by a factor of five and several European archaeological networking initiatives now include synchrotron facilities. New ways of operating have been put into practice thanks to the unique advantages that synchrotron radiation offers, including high brightness, small beam size and wavelength tunability. The resources available at synchrotron facilities, such as high quality equipment and computing, have also played a part in this as demonstrated by the increasing number of dedicated workshops and conferences. Archaeometry increasingly requires access to synchrotron radiation-based techniques such as X-ray imaging, X-ray diffraction, X-ray fluorescence and FTIR spectroscopy. Cultural heritage is also an area of scientific research that captures the public imagination and is therefore highly appreciated in the outreach activities that synchrotrons and similar facilities are undertaking.

The aim of this section is to demonstrate the methodological strategies developed for archaeometry rather than to give an exhaustive view of the archaeometry-related activities at synchrotron radiation facilities. A description of the current situation is given by Pantos (2007) and Bertrand (2007). Figure 1.5.13 presents a schematic overview of the different aspects of archaeometry, in terms of diversity and complexity of samples, technical and instrumental requirements and variety of problems.

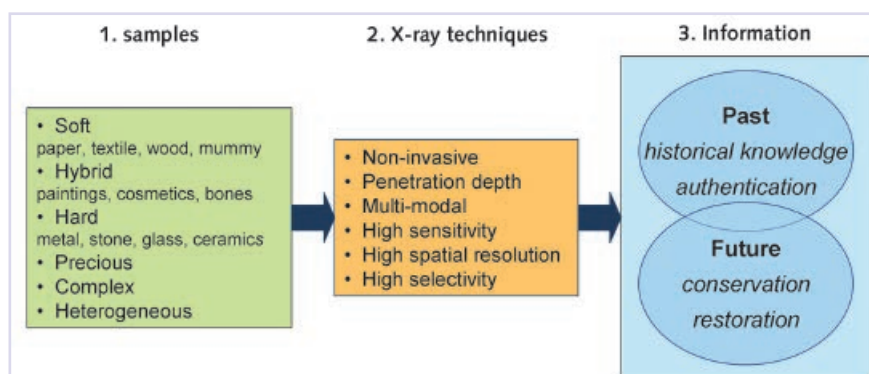

Figure 1.5.13: Cultural heritage objects fall into two main chronological classes: Past and Future. Both categories share common technical challenges, which are mainly linked to the nature, value and complexity of the material.

The Upgrade Programme will allow an evolution of archaeometry from descriptive to comprehensive studies. This transition will, in particular, involve innovative materials science developments for *in situ* experiments and time-resolved analyses.

Understanding the past

Studies of the past are intended to reveal the way of life, trades, rituals and knowledge acquired by ancient civilisations. Information can be obtained through the chemical analysis of relics that may include everyday objects and works of art.

Common objects (for example, pottery, cosmetics, textiles, human remains) can provide information directly or indirectly about an ancient way of life, such as chemical, medical, and engineering knowledge, diet and how trade took place. Fragments of cosmetics from ancient Egyptian tombs were investigated at the ESRF by high-resolution powder diffraction and microbeam X-ray fluorescence and diffraction in concert with a variety of laboratory techniques. Information about the composition, formulation and origins of the materials was deduced from the synchrotron measurements. In particular, it was discovered that Egyptians mastered not only fire-based technology but also wet chemistry as long ago as 2000BC (Walter *et al.*, 1999).

Works of art are usually good indicators of the highest degree of technology used within a particular society. They may represent the state-of-the-art in fields such as metallurgy, glass, ceramics, painting, sculpture and drawing. Artists try to find a good compromise between aesthetics and durability. This led to the development of sophisticated processes that can be discovered through research. Chemical analyses reveal the ingredients used and the different processes involved in combining these ingredients such as physical treatments (crushing, curing, etc.) or chemical reactions (purification, extraction, synthesis, etc.). In addition to the historical knowledge acquired, the question of authentication may also be solved through identification of pigments. For

example, intense research is carried out to understand the presence of nanoparticles in lustres, and their effect on the colour. Lustre decorations in glazes of historical pottery consist of copper and silver nanoparticles dispersed in a glassy medium. To determine the glaze composition and distribution of copper nanoparticles, copper ions, and their local environment requires non-destructive techniques such as Rutherford backscattering spectrometry, ultraviolet and visible spectroscopy, X-ray fluorescence, and extended X-ray absorption fine structure (EXAFS) (Padovani *et al.*, 2003, Smith *et al.*, 2006, Roqué *et al.*, 2006).

Anticipating the future

In addition to unveiling hidden information in ancient objects, it is also essential to preserve these relics for future generations. One third of the recent cultural heritage studies at the ESRF dealt with conservation and restoration.

Degradation mechanisms are the subject of intensive studies. Organic materials are obviously the most susceptible to suffer from this phenomenon, but hard materials such as pigment, glass or metal can also be subject to alteration (colour variation, corrosion, etc.). Oxidation-reduction reactions are the main causes of degradation, which explains the advantage of spectroscopic techniques in studying these phenomena. Micro X-ray absorption near edge spectroscopy has been used by Swedish and British researchers to gain a better understanding of wood degradation in marine-archaeological oak timbers such as the Mary Rose and Vasa (Sandström *et al.*, 2005). The study of sulphur speciation is also a key point in understanding the mechanisms involved in cinnabar blackening. This alteration is a dramatic



Figure 1.5.14: A wall showing the severe damage due to blackening of cinnabar in Poppea's villa in Oplanti (left). Visible light microscopy image showing debased and intact layers (pigment) and limestone (substrate) (top right). μ XANES allows the identification of the debased layer (bottom right).

phenomenon observed in ancient red paintings from Pompeii (Cotte *et al.*, 2006) (Figure 1.5.14). The cause of the blackening is still not completely understood.

A better understanding of alteration mechanisms is needed to limit further degradation. It is also useful in developing preventive restoration. In most cases, curative treatments have to be put into practice. The impact of such treatments must be assessed thoroughly, because they should restore previous alterations, without inducing any further weakening. For example, micro X-ray diffraction was used to determine the spatial resolution of mineral and lipid distribution in parchment. The effects of surface cleaning X-ray microdiffraction mapping made it possible to analyse features present only in specific areas of the parchment, such as on the surface (Kennedy *et al.*, 2004). The darkening of ancient documents over time (foxing) is another chemical alteration process which is not yet fully understood (Figure 1.5.15). The change of colour suggests a change of energy levels in the optical range. Many documents contain iron whose chemistry is believed to be involved in the colour change. New spectroscopy techniques such as XAS-XES are ideally suited to study the change of electronic structure and whether new bonds and ligands are formed around the iron that may cause the darkening process. XES has, until now, not been used as a tool for chemical characterisation in the field of cultural heritage. The detector improvements foreseen in the Upgrade Programme will permit XES to become applicable for samples with low metal concentrations.

Instrumental and methodological challenges

A wide variety of instruments are commonly used to obtain information from ancient objects. Most of

these involve classical laboratory techniques, whose set makes it possible to probe samples at different levels (atomic, molecular, structural), at different scales (from millimetres to nanometres), and with different sensitivities (major to trace elements). Laboratory instruments have become more and more powerful and remain the prime equipment for the study of cultural heritage objects. Two recent evolutions to this, however, should be underlined. First, portable instruments enabling *in situ* analyses (at excavation sites, museums, monuments, etc.) have been developed. In addition, specific studies require a higher level of performance and are only possible on large-scale facilities such as synchrotron radiation and neutron facilities.

Interactions between the synchrotron radiation and archaeometry communities should be reinforced. Indeed, this synergy is essential for a global understanding of all phenomena. In particular, it is essential to go further than the simple descriptive studies towards more fundamental works incorporating a deeper analysis of the phenomena. To achieve this, cross-fertilisation with other disciplines such as chemistry, material sciences and biology will be an essential factor of development.

The Upgrade Programme will not only provide a unique portfolio of highly specialised instruments via the development of new beamlines. It will also offer a favourable environment for further development by promoting fundamental factors such as access to multi-modal and multi-scale information, access to a broad range of energy and, in particular, to high energies.

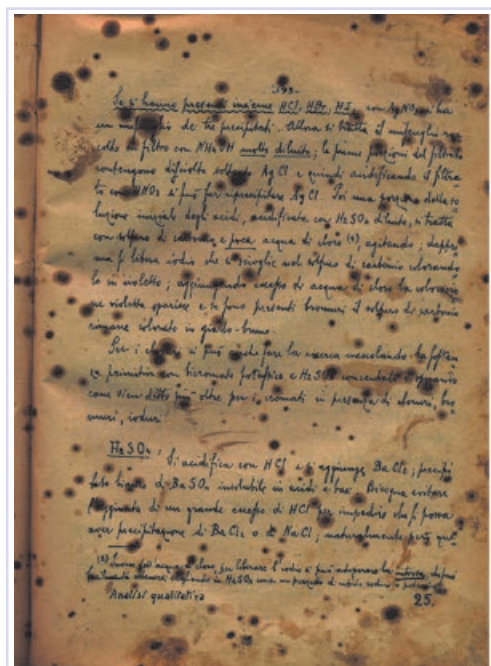

Courtesy of ICPL - Rome, Italy

Figure 1.5.15: Foxing spots on an ancient document.

The enhanced powder diffraction instrument will be a unique tool for both quantitative phase analysis of complex mixtures and fine microstructure analysis (see CDR **POW**). Similarly, one of the main added values of synchrotron FTIR microscopy over classical FTIR microscopy is the possibility of easily reducing the spot size down to $\sim 5 \times 5 \mu\text{m}^2$ instead of $\sim 20 \times 20 \mu\text{m}^2$ (Cotte *et al.*, 2005). The new and very innovative project of a near-field FTIR microscope (see CDR **SMILE**) with an anticipated spatial resolution of just 100 nm would have a significant impact on chemical and molecular characterisation. Conventional X-ray absorption spectroscopy (EXAFS) has proven to be a powerful tool for archaeometric studies. The future combination with high spatial resolution, as foreseen for the microspectroscopy beamlines (see CDRs **SMILE** and **XMAN**), will give access to structural and molecular information. Furthermore, new spectroscopic techniques such as X-ray emission after photoexcitation (XES) are expected to provide even more accurate spectroscopic information for some specific applications involving metals and ligands (see CDR **XAS-XES**). Finally, *in situ* chemical or time-resolved studies (corrosion or consolidation kinetic synthesis processes) are still underexploited by this community.

Coordination and synergy between the different beamlines will be necessary. A simple but customised scientific interface should aim at easing the access of researchers to the synchrotron, facilitating contacts, providing technical support and informing the community. This ESRF project must be envisioned in a collaborative way with other similar or even more ambitious interface frameworks such as the one envisaged at SOLEIL (Bertrand *et al.*, 2006).

Finally, not only is cultural heritage enormously valuable in itself, but also it is a key contributor to the economy, in particular by stimulating tourism. It has been estimated that heritage generates income in trade and services to Europe of the order of 334 billion euros per year. This large European industry relies in part on the integrity of cultural heritage. This activity is given significant support from various Europe networks and funding organisations (*e.g.* FP6, FP7, COST-G8, EU-ARTECH).

In conclusion, the Upgrade Programme, with its technical and methodological advances, will offer a unique opportunity to consolidate the new but still fragile interface between the archaeological science and synchrotron communities. The ESRF will then play a central role in this emerging application area.

Relevant Conceptual Design Reports:

- **EDXAS-L**: Energy Dispersive Absorption Spectroscopy (large spot)
- **EDXAS-S**: Energy Dispersive Absorption Spectroscopy (small spot)
- **EXAFS**: Extended X-ray Absorption Fine Structure Spectroscopy
- **IMPACT**: Imaging using Parallel Beam and Computed Tomography
- **POW**: High Resolution Powder diffraction
- **SFINX**: Scanning Fluorescence and Imaging at the Nanoscale using X-rays
- **SMILE**: Spectro-Microscopy and Imaging at Low Energies
- **XAS-XES**: Steady-State and Time-Resolved X-ray Absorption and Emission Spectroscopy
- **XMAN**: X-ray Spectroscopy Multi-Imaging Analysis

Key enabling technologies and infrastructures:

- Cultural heritage studies require a large set of techniques: all that is required for nanofocusing, imaging, diffraction, microanalysis, sample preparation and characterisation laboratories, and high quality detectors is valid in this case.

References

- Beaucage G., Kammler H.K., Mueller R., Strobel R., Agashe N., Pratsinis S.E., and Narayanan T. (2004), Probing the dynamics of nanoparticle growth in a flame using synchrotron radiation, *Nature Mater.*, **3**, 370.
- Bertrand L. (2007), <http://www.synchrotron-soleil.fr/anglais/applications-industry/heritage/references-en.htm>
- Bertrand L., Vantelon D., and Pantos E. (2006), Novel interface for cultural heritage at SOLEIL, *Appl. Phys.*, **A 83**, 225-228.
- Biston M.C., Joubert A., Adam J.F., Elleaume H., Bohic S., Charvet A.M., Estève F., Foray N., and Balosso J. (2004), Cure of Fisher rats bearing radio resistant F98 glioma treated with cis-platinum and irradiated with monochromatic synchrotron X-rays, *Cancer Res.*, **64**, 2317-2323.
- Blattmann H., Gebbers J.-O., Brauer E., Bravin A., Le Duc G., Burkard W., Di Michiel M., Djonov V., Slatkin D.N., Stepanek J., and Laissue J.A. (2005), Applications of synchrotron X-rays for radiotherapy, *Nucl. Instrum. Meth.*, **A 548**, 17-22.
- Bravin A., Keyriläinen J., Fernandez M., Fiedler S., Nemoz C., Karjalainen-Lindsberg M.-L., Tenhunen M., Virkkunen P., Leidenius M., von Smitten K., Sipilä P., and Suortti P. (2007), High-resolution CT by diffraction-enhanced X-ray imaging: mapping of breast tissue samples and comparison with their histo-pathology, *Phys. Med. Biol.*, **52**, 2197-2211.
- Broecker, W.S. (2007), CO₂ arithmetic, *Science*, **315**, 1371.
- Brunet M., Guy F., Pilbeam D., Lieberman D.E., Likius A., Mackaye H.T., Ponce de Leon M., Zollikofer C.P.E., and Vignaud P. (2005), New material of the earliest hominid from the Upper Miocene of Chad, *Nature*, **434**(7034), 755-759.

- Burgisser A. and Scaillet B. (2007), Redox evolution of a degassing magma rising to the surface, *Nature*, **445**, 194-197.
- Chaimanee Y., Jolly D., Benammi M., Tafforeau P., Duzer D., Moussa I., and Jaeger J.-J. (2003), A Middle Miocene hominoid from Thailand and orangutan origins, *Nature*, **422**, 61-65.
- Chappard C., Peyrin F., Bonnassie A., Lemineur G., Brunet-Imbault B., Lespessailles E., and Benhamou C.L. (2006), Subchondral bone micro-architectural alterations in osteoarthritis: a synchrotron micro-computed tomography study, *Osteoarthritis Cartilage*, **14**(3), 215-223.
- Chen J.-Y., Bottjer D.J., Davidson E.H., Dornbos S.Q., Gao X., Yang Y.-H., Li C.-W., Li G., Wang X.-Q., Xian D.-C., Wu H.-J., Hwu Y.-K., and Tafforeau P. (2006), Phosphatized polar-lobe-forming embryos from the Precambrian of southwest China, *Science*, **312**, 1644-1646.
- Cotte M., Dumas P., Richard G., Breniaux R., and Walter Ph. (2005), New insight on ancient cosmetic preparation by synchrotron-based infrared microscopy, *Anal. Chim. Acta*, **553**(1-2), 105-110.
- Cotte M., Susini J., Metrich N., Moscato A., Gratzio C., Bertagnini A., and Pagano M. (2006), Blackening of Pompeian cinnabar paintings studied by X-ray micro-spectroscopic imaging, *Anal. Chem.*, **78**, 7484-7492.
- Cuif J.P., Dauphin Y., Doucet J., Salome M., and Susini J. (2003), XANES mapping of organic sulfate in three scleractinian coral skeletons, *Geochim. Cosmochim. Acta*, **67**(1), 75-83.
- De Angelis M., Petit J.R., Savarino J., Souchez R., and Thiemens M.H. (2004), Contributions of an ancient evaporitic-type reservoir to subglacial Lake Vostok chemistry, *Earth Planet. Sci. Lett.*, **222**(3-4), 751-765.
- Farnan I., Cho H., and Weber W.J. (2007), Quantification of actinide alpha-radiation damage in minerals and ceramics, *Nature*, **445**, 190-193.
- Frisia S., Borsato A., Fairchild I.J., and Susini J. (2005), Variations in atmospheric sulphate recorded in stalagmites by synchrotron micro-XU and XANES analyses, *Earth Planet. Sci. Lett.*, **235**(3-4), 729-740.
- Golosio B., Somogyi A., Simionovici A., Bleuët P., Lemelle L., and Susini J. (2004), Non destructive three-dimensional elemental micro-analysis by combined helical X-ray micro-tomographies, *Appl. Phys. Lett.*, **84**, 2199-2201.
- Guilhaumou N., Sautter V., and Dumas P. (2005), Synchrotron FTIR microanalysis of volatiles in melt inclusions and exsolved particles in ultramafic deep-seated garnets, *Chem. Geol.*, **223**(1-3), 82-92.
- Harada E., Sarret G., Isaure M.P., Geoffroy N., Fakra S., Marcus M.A., Birschwilks M., Clemens S., Manceau A., and Choi Y.E. (2006), Detoxification of zinc in tobacco (*Nicotiana tabacum* L.) plants: Exudation of Zn as Ca-containing grains through the trichomes, *Plant Cell Physiol.*, **47**, S155-S155.
- Kennedy C.J., Hiller J.C., Lammie D., Drakopoulos M., Vest M., Cooper M., Adderley W.P., and Wess T.J. (2004), Microfocus X-ray diffraction of historical parchment reveals variations in structural features through parchment cross sections, *Nano Letters*, **4**(8), 1373-1380.
- Kersting A.B., Efund D.W., Finnegan D.L., Rokop D.J., Smith D.K., and Thompson J.L. (1999), Migration of plutonium in groundwater at the Nevada Test Site, *Nature*, **396**, 56-59.
- Manceau A., Marcus M.A., and Tamura N. (2002), Quantitative speciation of heavy metals in soils and sediments by synchrotron X-ray techniques. In *Applications of Synchrotron Radiation in Low-Temperature Geochemistry and Environmental Sciences*. Mineralogical Society of America, Washington, DC, publication 49, pp. 341-428.
- Metrich N., Susini J., Foy E., Farges F., Massare D., Sylla L., Lequien S., and Bonnin-Mosbah M. (2006), Redox state of iron in peralkaline rhyolitic glass/melt: X-ray absorption micro-spectroscopy experiments at high temperature, *Chem. Geol.*, **231**(4), 350-363.
- Montagna P., McCulloch M., Taviani M., Mazzoli C., and Vendrell B. (2006), Phosphorus in cold-water corals as a proxy for seawater nutrient chemistry, *Science*, **312**(5781), 1788-1791.
- Mooney D. (2005), One step at a time, *Nature*, **436**, 468-469.
- Novikov A.P., Kalmykov S.N., Utsunomiya S., Ewing R.C., Horreard F., Merkulov A., Clark S.B., Tkachev V.V., and Myasoedov B.F. (2006), Colloid transport of plutonium in the far-field of the Mayak Production Association, Russia, *Science*, **314**, 638-641.
- Padovani S., Sada C., Mazzoldi P., Brunetti B., Borgia I., Sgamellotti A., Giulivi A., D'Acapito F., and Battaglin G. (2003), Copper in glazes of Renaissance luster pottery: Nanoparticles, ions, and local environment, *J. Appl. Phys.*, **93**(12), 10058-10063.
- Pantos M. (2007), <http://srs.dl.ac.uk/arch/>
- Pinzani M.C.C., Somogyi A., Simionovici A.S., Ansell S., Steenari B.M., and Lindqvist O. (2002), Direct determination of cadmium speciation in municipal solid waste fly ashes by synchrotron radiation induced mu-X-ray fluorescence and mu-X-ray absorption spectroscopy, *Environ. Sci. Technol.*, **36**(14), 3165-3169.
- Risser L., Plouraboué F., Steyer A., Cloetens P., Le Duc G., and Fonta C. (2007), From homogeneous to fractal normal and tumorous microvascular networks in the brain, *J. Cereb. Blood Flow Metab.*, **27**(2), 293-303.
- Roqué J., Molera J., Sciau P., Pantos E., and Vendrell-Saz M. (2006), Copper and silver nanocrystals in lustre lead glazes: development and optical properties, *J. Eur. Ceram. Soc.*, **26**(16), 3813-3824.
- Rothschild L.J. and Mancinelli R.L. (2001), Life in extreme environments, *Nature*, **409**, 1092-1101.
- Sandström M., Jalilehvand F., Damian E., Fors Y., Gelius U., Jones M., and Salomé M. (2005), Sulfur accumulation in the timbers of King Henry VIII's warship Mary Rose: A pathway in the sulfur cycle of conservation concern, *Proc. Natl. Acad. Sci. USA*, **102**(40), 14165-14170.
- Segers J., Le Duc G., Laumonier C., Tropres I., Vander Elst L., and Muller R.N. (2005), Evaluation of Gd-EOB-DTPA uptake in a perfused and isolated mouse liver model. Correlation between magnetic resonance imaging and monochromatic quantitative computed tomography, *Invest. Radiol.*, **40**(9), 574-582.
- Serduc R., Vérant P., Vial J.-C., Farion R., Rocas L., Rémy C., Fadlallah T., Brauer E., Bravin A., Laissus J., Blattmann H., and van der Sanden B. (2006), *In vivo* two-

photon microscopy study of short-term effects on normal mouse brain microvasculature after microbeam irradiation, *Int. J. Radiat. Oncol. Biol. Phys.*, **64**(5), 1519-1527.

- SLAC (2003), *Molecular Environmental Science: An Assessment of Research Accomplishments, Available Synchrotron Radiation Facilities, and Needs*. 2003 Report of EnviroSync - A National Organization of Environmental Science Users of Synchrotron Radiation Sources. <http://www.slac.stanford.edu/cgi-wrap/pubpage?SLAC-R-704>.
- Smilowitz H.M., Blattmann H., Bräuer-Krisch E., Bravin A., Di Michiel M., Gebbers J.-O., Hanson A.L., Lyubimova N., Slatkin D.N., Stepanek J., and Laissue J.A. (2006), Synergy of gene-mediated immunoprophylaxis and unidirectional microbeam radiation therapy for advanced intracerebral rat 9L gliosarcomas, *J. Neuro-Oncol.*, **78**, 135-143.
- Smith A.D., Pradell T., Roqué J., Molera J., Vendrell-Saz M., Dent A.J., and Pantos E. (2006), Colour variations in 13th Century Hispanic lustre an EXAFS study, *J. Non-Crystalline Solids*, **352**, 5353-5361.
- Smith T.M., Tafforeau P., Reid D.J., Grün R., Eggins S., Boutakiout M., and Hublin J.-J. (2007), Earliest evidence of modern human life history in North African early Homo sapiens, *Proc. Natl. Acad. Sci. USA*, **104**, 6128-6133.
- Tafforeau P., Boistel R., Boller E., Bravin A., Brunet M., Chaimanee Y., Cloetens P., Feist M., Hozzowska J., Jaeger J.-J., Kay R.F., Lazzari V., Marivaux L., Nel A., Nemoz C., Thibault X., Vignaud P., and Zabler S. (2006), Applications of X-ray synchrotron microtomography for non-destructive 3D studies of paleontological specimens, *Appl. Phys. A, Mater. Sci. Process.*, **83**, 195-202.
- Walker J.J., Spear J.R., and Pace N.R. (2005), Geobiology of a microbial endolithic community in the Yellowstone geothermal environment, *Nature*, **434**(7036), 1011-1014.
- Walter Ph., Martinetto P., Tsoucaris G., Breniaux R., Lefebvre M.-A., Richard G., Talabot J., and Dooryhée E. (1999), Making make-up in ancient Egypt, *Nature*, **397**, 483-484.
- Zahradka K., Slade D., Bailone A., Sommer S., Averbeck D., Petranovic M., Lindner A.B., and Radman M. (2006), Reassembly of shattered chromosomes in *Deinococcus radiodurans*, *Nature*, **443**, 569-573.



The European Light Source

ESRF SCIENCE AND TECHNOLOGY PROGRAMME 2008-2017

PART 2

**Technology and Engineering
Challenges**



Overview to PART 2

Technology and Engineering Challenges

A consistent programme of synchrotron beamline instrumentation and associated engineering developments is necessary to enable the challenging scientific areas of the Upgrade Programme to be put into practice: advances in experimental techniques and improved instrumentation lead to new science.

All beamlines have six fundamental requirements:

- Beam conditioning: high quality optics and high stability.
- X-ray detectors: faster readout, higher dynamic range, increased sensitivity and functionalities allowing online data analysis.
- Sample positioning: navigation, recognition, manipulation and control.
- Sample environment: special (often variable and extreme) conditions.
- Accessible beamline control: *e.g.* through graphical user interfaces and use of automation.
- Online data analysis and advanced data storage and retrieval (described in [chapter 3.3](#)).

Part 2 describes the Upgrade technology and engineering programmes necessary to fulfil these requirements and, in turn, carry out the new science outlined in Part 1. Details of the infrastructures that underlies the science, technology, and engineering are presented in Part 3.

The first, most fundamental requirement for a beamline is to deliver a stable, brilliant beam to the sample. This requires high performance optics that maintain stability under the intense heat load from the source, without deformation leading to a loss of coherence or degradation of the energy bandpass or focal spot size. The developments foreseen in this area are presented in [chapter 2.1](#).

Large parts of the ESRF science programme, detailed in Part 1, will rely on high spatial resolution imaging techniques. More recent developments exploit the partial coherence of synchrotron X-ray beams for phase contrast imaging or coherent diffraction imaging. These imaging experiments on the nanometre scale ([chapter 2.2](#)) need not only focal spot sizes in the nanometre range, but also nanometre stability of the experiment. Reaching the necessary stability requires low vibration, low (thermal) drift mechanical designs and feedback systems. Methods of handling nanosamples will become critical and require complementary techniques, *e.g.* in order to identify the point of interest on the sample through atomic force microscopy (AFM) or optical microscopy.

Pump-and-probe techniques (see [chapter 2.3](#)) are increasingly being used to study fast dynamics, *e.g.* the evolution of a chemical process initiated by an external stimulus ([chapter 1.3](#)). Diffraction studies after laser excitation were pioneered at the ESRF. The fastest timescales, down to 100 ps, need a maximum photon flux per electron bunch. Pump-and-probe experiments will therefore benefit from advances in wide bandpass X-ray optics (*e.g.* multilayer monochromators) and the source (*e.g.* increased length of the straight sections, optimised insertion devices). In addition to an extension of pump-and-probe diffraction activities, the Upgrade will also allow the development of pump-and-probe techniques in combination with X-ray absorption and emission studies. These experiments are an important stepping stone towards ultra-fast experimental resolution with X-ray free electron laser (XFEL) sources. Nonetheless, for timescales of 100 ps and above, storage ring-based techniques are expected to retain their competitive advantage.

For large parts of the new science, it is crucial to extend the range of extreme temperatures, pressures, magnetic fields, and combinations thereof. Developments foreseen for sample environments and extreme conditions are presented in [chapter 2.4](#). High-pressure sample environments combined with high temperatures are needed in the fields of geophysical research and planetary sciences ([chapter 1.3](#)). Furthermore, studies of, for example, electron correlations ([chapter 1.4](#)), rely on the combination of these high-pressure sample environments with low temperatures. This combination is particularly interesting when used with high magnetic fields. Indeed, one of the most ambitious projects within the Upgrade Programme is to implement pulsed and static magnetic fields in the range of 30 to 50 T on the joint ESRF/ILL site. Steady (DC) field magnet installations are expensive to implement and operate. The solution lies in the form of a European High Magnetic Field Facility, which has been put forward as a proposal within the framework of the Upgrade Programme. This will involve close collaboration between the ESRF, ILL, and other European high magnetic field laboratories to make DC magnetic fields higher than 30 T available for X-ray and neutron scattering.

Detectors are not only vital for the ESRF, but also for all other synchrotron radiation research centres. [Chapter 2.5](#) outlines the ESRF's collaborative plans for detector development. Detectors are very often the weakest part of scientific experiments. In the past, this has been addressed by a global remedy, based on a large qualitative improvement of the X-ray source. Better results can be achieved by addressing the "detector handicap" directly. An X-ray detector programme based on the most advanced technology is needed to collect data with more efficiency, resolution, sensitivity and speed. This quest for better detectors is shared by all light sources, and provides a great opportunity for collaboration between specialists in physics, optics, electronics, computing science and others. Dedicated detectors specialised for a given type of experiment will produce the highest impact. A variety of detectors must therefore be developed allowing samples to be studied that are currently too small, too diluted, or too difficult to produce in the required size and shape.

The technical feasibility of several key questions will be addressed through pilot studies, some of which have already been initiated (*e.g.* ID11,

ID13, ID22 nanoimaging, and pulsed magnetic fields). The implementation of new instrument suites and control packages will be greatly facilitated by stations dedicated to *in situ* testing and optimisation of beamline components.

The engineering and technology goals can only be achieved if a new, integrated approach is established that combines the different expertise of engineers and experimenters. The design, for example, of a nano-compatible beamline, must be considered as a whole, and not as an assembly of isolated modules. Its future operation and maintenance must be taken into account from the start. As a result, future beamlines will perform more efficiently and will be easier to maintain and operate by both users and support staff.

Partnerships and collaborations with other institutions should be the main methods in which knowledge is shared. Initiatives have already been made in collaboration with other synchrotrons in the field of nano-engineering and others are being actively assembled (for example in optics development and nano-characterisation). Such collaborations will allow the instrumentation that reflects the main needs of the Upgrade Programme *and* of other European synchrotron radiation facilities to be developed in the most effective way. Detector developments, remote haptic manipulation and high-pressure and magnetic field sample environments are amongst the other areas where the ESRF can most actively contribute or join existing developments. These partnerships and collaborations will strongly benefit from access to the instrumentation test beamlines.

2.1. Beamline engineering developments

Science context

Synchrotron radiation experiments require high quality beamline instrumentation. In order to address the scientific questions laid out in Part 1, common and more specific aspects of ESRF beamline engineering must advance. Elements common to all beamlines include X-ray optics (especially nanofocusing optical elements) and beamline control. Future scientific experiments will require optical components able to withstand higher heat loads, while preserving the coherence of the beam. Nanometre-scale science requires novel focusing systems with unprecedented levels of thermal and mechanical stability to operate on a routine basis. To implement new developments effectively on the beamlines, test facilities are needed, and the different elements must be integrated into a coherent package. These needs are common to all synchrotron radiation facilities. Substantial amounts of beam time are needed to prototype, optimise and commission modern, complex instruments, and to perfect their control software (including high levels of automation). Yet, no dedicated test station on an undulator source is available in Europe. A central test facility, open to collaborations and common projects, would thus be of enormous benefit for European synchrotron science.

Added value of the Upgrade

The new beamlines rely on considerable advances responding to the context described above which will underpin the science of the Upgrade. These requirements will be met by important component programmes assimilated by the Upgrade Programme:

- Managing high heat loads: The development of optics and engineering to handle high heat loads efficiently whilst maintaining high quality performance of the beamline components.
- Preservation of coherence: Coherence of X-ray light is increasingly valuable in experiments at synchrotrons and methods to improve the preservation of coherence through to the sample will be further developed.
- Optics: The development of standard, high

stability optics to obtain beams down to 10 nanometres in size whilst being able to sustain high heat loads and preserve coherence.

- Two instrumentation stations (white and monochromatic beams): The provision of central test facilities for instrumentation installed on undulator sections and open to the European community.
- Beamline control: The collaborative development of a common European beamline control software platform able to handle sophisticated instrumentation whilst still allowing customisation to particular user and experiment demands.

Partnerships

The challenges for beamline engineering are common to all of the European light sources. The developments will therefore benefit from the deployment of new collaborative structures that involve the whole of the synchrotron radiation community. Beamline engineering will be facilitated by the strengthening of existing partnerships and new laboratories (from nanopositioning to biomedical subjects, from high pressure to control electronics and software, and from precision metrology to microfluidics) will be opened to encourage new partnerships to establish collaborative development platforms. A key part of these alliances will be the instrumentation beamlines of the Upgrade Programme, which will play the important role of test bench for many of the European organisations interested in synchrotron radiation instrumentation developments.

Industry and technology transfer

Collaboration with industry is extremely important. Partnerships amongst different institutions will be aided by the creation and support of a network of agile small and medium enterprises capable of translating the needs and ideas of research into instruments or components. The hands-on training of facility and industrial engineers will be one of the objectives of the instrumentation beamlines.

2.1.1. Introduction

Beamline instrumentation is a fundamental part of the scientific experiment and must evolve with the science. This chapter deals with the more general aspects of beamline engineering requirements (X-ray optics, including nanofocusing optical elements, beamline control, test facilities and integration) whilst engineering specific to nanoscale science (especially imaging) is presented in [chapter 2.2](#). Technological questions specific to pump-and-probe experiments are addressed in [chapter 2.3](#). Engineering for sample environments is described in [chapter 2.4](#), and detector developments are presented in [chapter 2.5](#).

All beamlines rely on X-ray optical systems to deliver the beam to the sample. Beam conditioning is critical for the delivery of a beam tailored to the sample under study, and to the X-ray technique that is employed. In order for reliable, reproducible data to be collected, the beam has to be as stable as possible, as intense as possible (in particular, for high-resolution techniques such as inelastic scattering and nuclear resonance) and as coherent as possible (in particular, for nanofocusing and imaging techniques). How the Upgrade Programme will address these points is detailed in [section 2.1.2](#). One aspect of crucial importance for the stability of the beam is the management of the high heat load coming from the source. Coherence preservation relies on the optical perfection of reflecting and diffracting surfaces (see also [section 2.1.2](#)), as does nanofocusing.

All engineering developments need to be tested and optimised before they can reach their full potential in daily operation. To this end, the Upgrade Programme proposes the revision and new implementation of several support laboratories (see [section 2.1.3](#)). These will be complemented by test beamlines (see [section 2.1.4](#)) that will allow characterisation of X-ray optical elements under realistic conditions (CDRs **WIBIDI** and **TIBIDI**). These stations will also serve as training facilities for students, technicians, engineers and scientists. The increasing requirements in terms of coherence preservation and nanofocusing demand mirror surfaces of unprecedented perfection, beyond the limit of present industrial techniques. To overcome this limitation, the Upgrade Programme includes proposals (CDR **OPTICS**) for a mirror surfacing facility (also presented in [section 2.1.4](#)).

Beamline control has evolved significantly over the last few years. Starting out from simple code performing the geometry calculations for a single diffractometer with point detectors, the control package "spec" used at the ESRF now takes on tasks as diverse as high-throughput readout of large 2D detectors, and automation of beamline operation. The underlying framework has clearly reached its limits. In order to increase flexibility, reliability, and

functionality, a new instrument control package will be developed ([section 2.1.5](#)). First steps to this end have been undertaken in collaboration with international partners.

Modern synchrotron X-ray experiments rely on the combination of a large number of engineering components, ranging from optics, focusing and beam conditioning, through sample manipulation and positioning and sample environment to detection systems and control and analysis software. In the past, these were largely regarded as independent modules. However, with the generalisation of increasingly complex, highly specialised beamlines, in particular those optimised for the study of nanoscale objects, this engineering paradigm needs to be shifted: the beamline as a whole needs to be optimised, and the different components, including control, have to be integrated (see [section 2.1.6](#)).

The majority of the instrumentation developments are of general interest to the synchrotron radiation community and, consequently, could be undertaken using collaborative approaches and EU programmes. Other developments will be driven by industry and input from the synchrotron light facilities will therefore be marginal. When faced with instrumentation and beamline engineering challenges, a significant part of the added value of the Upgrade Programme lies in its power to act as a catalyst to produce a network of expertise and encourage collaboration with laboratories to develop group efforts in the field of instrumentation. The ESRF can use its established knowledge and its future dedicated test and training beamlines (see CDRs **TIBIDI** and **WIBIDI**) to make a significant contribution to such a network. This is also the case for its coordination and/or development of specific projects. Partnerships and a "user programme" centred on instrumentation will rationalise access to the infrastructures and test beamlines and promote the development of common projects.

2.1.2. X-ray optical systems

High quality X-ray optical systems are critical when enabling technology to be used to deliver appropriately conditioned beams to the end stations ([Figure 2.1.1](#)). The ESRF Upgrade Programme will require a dynamic and well coordinated development programme for X-ray optics in order to guarantee optimal beams for the new experiments. The new, long beamlines could be available from 2012 onwards and so the optics development and production capacity must start to be put into place immediately. The ESRF expertise and experience will provide a foundation for developing and putting into practice the optics programme. The existing facilities will,

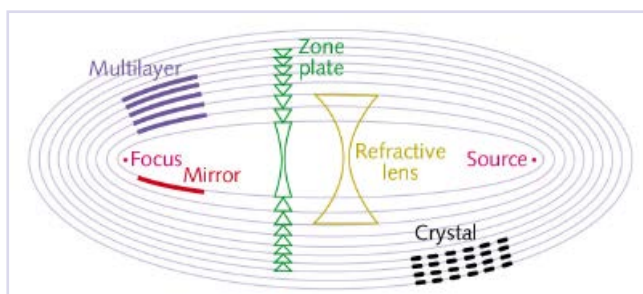

Figure 2.1.1: Schematic illustration of various X-ray optical elements for third-generation synchrotron beamlines.

The Upgrade Programme will improve the focusing capabilities of elements such as mirrors, multilayers, zone plates, and refractive lenses in order to reach the 10 nm spot size limit. High heat load monochromators based on crystals and multilayers will represent a second important area of development.

however, maintain their regular activity and their ability to ensure the continuing operation of the existing ESRF beamlines.

The science programme and infrastructure upgrade comprises four key targets that have been identified for optics instrumentation development:

- Stable nanofocusing optics
- High heat-load operation
- Coherence preservation
- Beam stability improvement or preservation and monitoring

Demand for high-performance X-ray optics at the European level is expected to grow rapidly in the coming years. A recent survey has shown that the total number of European X-ray beamlines will increase by approximately 50% by 2010 to reach three hundred. Micro- or nanofocusing techniques will be used by approximately one hundred of these beamlines. An integrated European initiative and strategy is required to make optics development and production sufficiently effective to embrace these dramatic changes. The Upgrade Programme will act as a catalyst in the co-ordination of this effort and provide the necessary optics development for the ESRF.

Managing high heat-loads

Improvements of the brilliance from the accelerator and source also increase the heat load on the beamline optics. In order to provide a stable X-ray beam to the user, the optical design has to limit thermal drift within very strict limits. New strategies have to be implemented to ensure that the beam quality is not degraded by the higher power and power densities incident on the optical components. For example, diamond or multilayer-based pre-monochromators could represent an elegant solution

to the problem. All high heat load components must incorporate passive and active stabilisation systems, such as smart shape design and advanced feedback.

The following technologies will be assessed:

- **Attenuators:** Metal coated diamond attenuators have proved useful in overcoming the limitations of conductive cooling in thin solid attenuating materials. Gas attenuators are a promising alternative way of preferentially removing the unwanted low energy fraction of high power beams. Still, their quality in terms of coherence preservation and transmission predictability and uniformity deserves further studies that will be very useful for development of new sources.

- **Cooling systems for crystal and multilayer monochromators:** The ESRF is one of the pioneers in implementing liquid nitrogen cooling for silicon monochromators. However, with increasing heat loads from the X-ray source, the limits of this technology are being reached. Within the Upgrade, new cooling geometries and crystal mounting techniques have to be developed and put into practice for a new generation of monochromators. The new applications lead to several types of monochromator arrangement, which are the consequences of an optimum use of the energy shaping, scanning, resolution and flux output. The present generation of monochromators is now limited by the vibration stability due to the cooling scheme and the thermal drifts of the crystal setup due to the cryo-arrangement. The use of a double crystal monochromator (DCM), or channel cut monochromator (CCM), cascaded or not with a pre-monochromator multilayer (MLM) will imply solving the thermal distortions of a silicon monocrystal, or substrate, which lead to optical degradation.

- **Development of multilayer-based monochromators:** A significant challenge lies in the development of high heat load multilayer-based monochromators offering a wide energy bandpass. These devices are of interest for high flux applications, where they can provide a gain in photon flux of about one hundred compared to silicon crystals. Alternatively, as pre-monochromators, they can reduce the heat load on downstream elements, and thus improve the overall stability of the beamline. However, problems such as multilayer structural stability, substrate dimensional stability, and the thermal behaviour between the layer and the bulk material are critical and need new approaches to be tested and assessed to find solutions. Studies and experimental tests of the influence of high intensity radiation on multilayers are rare due to the lack of access to appropriate X-ray sources and test facilities. Progress in this field depends on the availability of the white beam test station (see CDR **WIBIDI**).

This, in turn, necessitates continual development of the internal ESRF programme for substrate preparation and multilayer deposition which are essential ingredients for this activity as well as for improved coherence preservation (see below).

- Increasing the usage of diamond:** Diamond has extremely attractive thermal properties for high heat load applications and, in particular, is one of the rare candidate monochromator materials that could be used in XFELs. The ESRF has already gained valuable experience in implementing this material as a monochromator and it is used routinely in a number of ESRF beamlines in a beam splitting Laue geometry. Reliable sourcing of the material, which has relied on high-pressure high-temperature synthesis onto high quality natural seeds, has been a constant problem. Accessing such materials is important from a strategic point of view and requires close cooperation with the (usually industrial) material growers. Targeted improvements in high-pressure high-temperature diamond synthesis techniques should result in improved availability of diamonds for monochromator applications. Recent developments in CVD single crystal diamond growth are of particular interest. These have the potential to make high quality crystals widely available on an industrial scale. Such crystals are also critical for applications such as phase-plates when manipulating the X-ray beam polarisation. Herein lies the challenge for the Upgrade Programme: developing strain-free mounting systems for the diamond plate whilst still guaranteeing an optimised thermal exchange to dissipate the absorbed energy.

- High-power large-aperture parabolic refractive lenses** are ideal on-axis pre-monochromator collimators, but technical issues must be addressed: A larger aperture translates to a higher thermal load that needs to be dissipated without inducing thermal strain that would in turn deteriorate the optical characteristics. The roughness must be controlled to minimise the flare around the central beam, thereby reducing the overall background.

- White-beam mirrors** will mainly be used as low-pass filters to reduce the heat load on the monochromator. Thermal deformation of these mirrors could be significantly reduced or minimised to an acceptable level by introducing smart shape profiling to cancel the thermal bump leading to the slope error. There is a method of optimising a "blocking groove" which then attenuates the thermal expansion inside the bulk of the substrate lower than a fraction of microradian (Figure 2.1.2).

All along the beamline, a thermal design strategy will also help reduce beam instabilities that have their origin in variations of heat load on the beamline optics. As it has in the past, engineering will need to take into account a wide range of monochromator

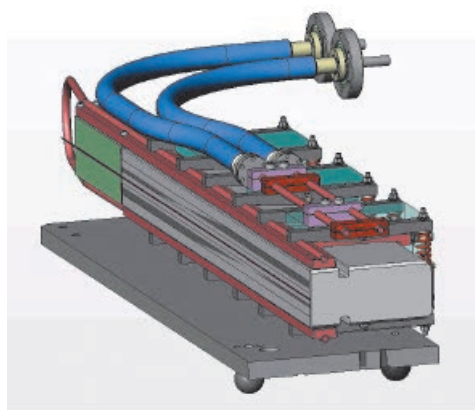

Figure 2.1.2: A low thermal slope error given by the white mirror of ID26. The groove on the mirror compensates the thermal slope error.

and mirror geometries including soft X-ray gratings, channel-cut and double crystal systems. Access to a test facility at an undulator beamline, both for monochromatic (CDR: **TIBIDI**) and white beam (CDR: **WIBIDI**), will be critical in establishing an effective development strategy for high heat load optics.

Coherence preservation

When the ESRF was founded, the frequent observation of coherent diffraction phenomena led to a growing awareness of the importance of the quality of optical surfaces for providing clean wavefronts. Wavefront aberration is detrimental to imaging applications, but may also lead to reduced throughput or unpredictable beam intensity profiles. Coherence preservation is therefore the main drive in reducing the slope errors and roughness of optical surfaces. At the ESRF, the off-line and online characterisation facilities (particularly coherent beam topography) have been essential tools in refining the surface preparation techniques.

- The continuing development of these facilities is important when shortening the production cycle of coherence preserving optics through both conventional polishing techniques and non-conventional surface finishing methods (based, for example, upon ion beam or differential deposition techniques; see CDR **OPTICS**).
- Integrating the optical components in their supports that can induce apparent losses in coherence via thermal deformation or mechanical vibration. Access to a white beam test facility will be the only effective way to overcome this.
- When making progress in the beamline optical specification, modelling of the effects of imperfect optical surfaces on wavefront propagation along the

beamlines must be considered. This is complementary to the classical ray-tracing approach (see also comments below under nanofocusing).

Integrating the optical components in their supports can induce losses in coherence, via thermal deformation or mechanical distortion. The last focusing element is most sensitive, in particular, when it is produced through dynamic benders. A major issue should be solving the athermal design between silicon substrate and its bending mechanism. Under a certain limit, optical wave front analysers (Shack-Hartmann) or capacitive sensors (global shape) might be required in order to obtain closed loop driven performances.

Nanofocusing

The last ten years have seen a remarkable improvement in the quality of X-ray focusing optics for use in the multi-keV and hard X-ray energy range (Figure 2.1.3). The properties of currently available nanofocusing elements for hard X-rays are summarised in Table 2.1.1. The ESRF has regularly

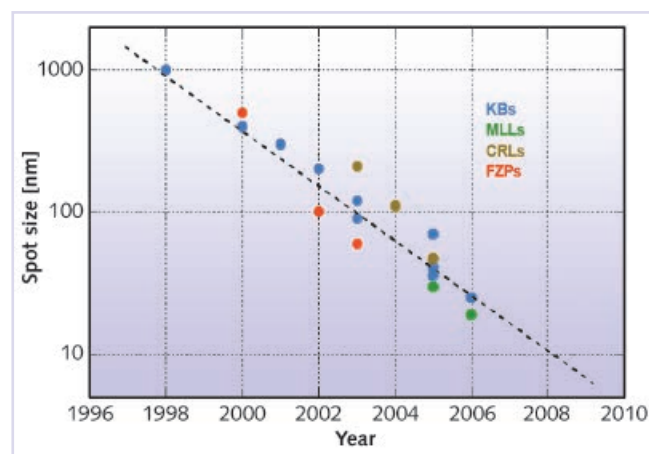

Figure 2.1.3: Historical evolution of the measured spot size (in nanometres) for different hard X-ray focusing elements (KB: Kirkpatrick-Baez mirror pair; MLL: multilayer Laue lenses; CRL: compound refractive lenses; FZP: Fresnel zone plate). There has been tremendous progress over the last ten years irrespective of the technology. An extrapolation of this trend would lead to the 10 nm level. Considerable effort will be necessary by the Upgrade Programme in the development of X-ray optics to continue this progress.

been at the forefront of these exciting developments. These X-ray optics are increasingly critical to present and future ESRF beamline operation; this has been emphasised in a large number of the CDRs. An essential point in carrying out this and other optics development studies is the availability of a state-of-the-art nano- and micro-optics test bench, which is rapidly accessible on an undulator test beamline (see CDR TIBIDI).

Routine X-ray focusing to the micro- and nanoscale will be a key technological challenge that will shape many of the future ESRF beamline developments (longer beamlines, complex sample environments). Current focusing optics based on diffraction, refraction and reflection have all demonstrated spatial resolutions in the 50 nm range and it is generally accepted that there are no physical barriers to achieving sub-10 nm resolutions. The diversity of the ESRF beamline requirements, particularly in terms of photon energy, energy resolution, focusing geometry, and sample environment, leads to the belief that no one type of optical device will dominate the applications in the foreseeable future. In many cases, when taking engineering aspects into account, optical systems and end station designs must maintain a high degree of modularity in order to readily implement new optical devices as they become available. Engineering initiatives on advanced nanofocusing optics should be supported by wave optical simulations to allow the resolution limits other than the fundamental diffraction limit to be identified and to help design optimised real optical devices.

Recent in-house developments for nanofocusing have concentrated on using dynamically bent reflective optics in the Kirkpatrick-Baez (KB) geometry. These systems rely on either total reflection or laterally graded multilayers. They have proved extremely versatile and stable, and around half of the ESRF beamlines routinely use them for user experiments. They are in the process of being licensed for technology transfer. KB mirrors are typically installed in close proximity to the sample. As the sample environments, available space, minimum distance to the focal spot, etc., vary strongly from one beamline to another, the mechanics and optics of the system must therefore be modified and adapted for installation. The next generation of KB systems should decrease the size of the focal spot down to the

| Type of optics | Reflective | Refractive | Diffraction | Waveguide |
|-------------------------|------------|------------------|-------------|------------|
| Achieved spot size [nm] | 25 | 50 | 20 | 25 |
| Efficiency | < 90% | < 50% | < 50% | < 10% |
| Energy range [keV] | 5-100 | 10-300 | 1-50 | 5-20 |
| Chromaticity | Achromatic | $f \sim E^2$ (E) | $f \sim E$ | Achromatic |
| Useful working distance | ~ cm | ~ mm | ~ mm | ~ μ m |

Table 2.1.1: Properties of nanofocusing elements for hard X-rays.

nanometre range. This goal can only be achieved if the residual slope errors are decreased significantly. A promising approach, to be explored within the Upgrade Programme, is to use pre-shaped substrates with very short focusing distance that are matched to the sample by an additional dynamic bending. These systems are rather complex and designed by both optics and mechanical engineering experts. They are a critical component in the field of nanofocusing and it is important to maintain and develop ESRF expertise in this field.

Compound refractive lenses (CRL), which originated at the ESRF, continue to play an important role in many beamline optical schemes. Close collaborations with external groups allow the ESRF to remain active in this field. The beryllium rotationally symmetric parabolic lenses, particularly suitable for the higher energy beamlines, are of growing importance. These components should therefore continue to be readily available.

The importance of this field has been recognised in the future development of the ESRF and many in-house developments in nanofocusing have already been initiated. The ESRF reflective optics programme will use a gradual migration towards statically profiled mirrors as a basis. Achieving the required highly ellipsoidal surfaces necessary for high demagnifications may be possible using approaches such as stressed-polishing. These will probably be combined with ion beam or differential-deposition finishing techniques in order to achieve the required surface quality. Preliminary tests on BM05 have shown that ion beam finishing in combination with X-ray wavefront analysis (shearing interferometer) can lead to control of the slope error in the ten picoradian range. The CDR OPTICS proposes the creation of a bending magnet station for optical surface finishing of large substrates suitable for the ESRF reflective optics programme.

In-house programmes are envisaged to develop multilayer Laue lenses (MLL) for high-efficiency, high-resolution, focusing of medium (~30 keV) energy X-rays. They would be based on experience gained at the APS and built using existing ESRF investment and expertise in multilayer deposition technology. Incorporating such optics into a useable optical system would require a highly integrated approach to the system, as is the case for the KB mirror development. Several bilateral programmes are also being conducted for the development of diffractive (Fresnel) optics and planar compound refractive or nanofocusing lenses (NFL). Developing such devices requires an infrastructure and expertise that is currently considered to be outside the core activities of the ESRF. Continuous collaboration with outside groups will be essential if these strategically important devices are to be acquired.

On the European scale, the future demand for the high-resolution focusing requirements of the X-ray beamlines of all of the light sources cannot be satisfied by the development of a single institute. The ESRF has therefore recognised the need for a coordinated approach in developing nanofocusing X-ray optics and has initiated a European collaboration programme intended to draw together and better coordinate expertise in this field. It is anticipated that the ESRF will continue, within this programme, to lead the development of nanofocusing reflective optics systems offering sub-100 nanometre resolution. This would be done within the context of an ultimate goal of attaining spatial resolutions of the order of 10 nm. The collaboration is intended to be wide ranging and currently involves partners from all European X-ray light sources and the major public research funded X-ray optics producers. In the future, this participation will be extended to involve a maximum of industrial partners. It could evolve into a forum influencing future X-ray optics developments in Europe.

2.1.3. Support laboratories

Carrying out the instrumentation programme requires a range of tools extending from nanotechnologies for optical elements, detectors and positioning systems to fast readout electronics, metrology, real-time modelling and software. A list of the supporting laboratories and tools that need to be improved or created is given in [Table 2.1.2](#).

Existing laboratories to be revised:

- Biomedical facility
- Chemistry and microanalysis laboratory
- Control electronics laboratory
- Detector laboratory
- Mechanical workshops and mounting areas
- Precision engineering and metrology laboratory
- Sample environment laboratory

New laboratories to be created:

- Embedded software development laboratory
- Engineering test facility (linked with CDRs WIBIDI and TIBIDI)
- Integration laboratory
- Laser laboratory (complementary to the integration and sample environment laboratory and timing experiments)
- Microfluidics laboratory
- Nanomanipulation laboratory

Table 2.1.2: Support laboratories to be improved or created.

A number of laboratories oriented towards direct support of scientific activities are also included for

completeness. These should be enhanced to match increased demands from the user community for on-site services beyond the direct X-ray experiment, such as sample preparation and characterisation.

2.1.4. Test beamlines and mirror surfacing facility

The Upgrade Programme aims to provide all of the beamlines with X-ray beams with unprecedented characteristics in terms of stability and dimensions combined with a large choice of sample environments and instrumentation for fast data acquisition and real-time reduction. The challenge for conceiving, manufacturing, integrating and validating a large variety of instruments (which range from detectors to optical systems, nanopositioning, automatic control, fast data acquisition, online data reduction, vibration and temperature control, sample environment, pump-and-probe) can only be faced if appropriate test benches are available to test, improve and assess innovative instrumentation. Within the Upgrade Programme, two undulator end stations, one monochromatic and one white beam, are envisaged for testing (CDRs: **TIBIDI** and **WIBIDI**, respectively).

TIBIDI: this monochromatic beam test station for instrumentation will be open to synchrotron radiation instrumentation developers on a proposal basis. It should be considered as the key infrastructure for a collaborative effort in instrumentation at the European level.

WIBIDI: the white beam test station will be used for the development, testing and qualification of white beam components, such as multilayer and diamond monochromators or devices for beam shaping (slits, attenuators, and filters). Extensive beam time will be dedicated to the development of a white beam position monitor capable of generating feedback to the source.

Both beamlines are also central to the development of new techniques or combinations of techniques that require several months of beam time and that are therefore *de facto* excluded from the normal beam time allocations. Another aim for these instrumentation beamlines is training. The complexity of synchrotron radiation instrumentation necessitates the specific training of future engineers and instrumentation scientists. The increasing pressure to use beam time profitably for user experiments does not allow young scientists, engineers and technicians to gain hands-on experience.

A bending magnet station will also be necessary to develop and improve the substrate finishing project. The performance of reflective optics is directly

related to the surface finishing of the substrate. Ion beam sputtering and/or selective deposition are critical techniques to reach the desired objectives. The CDR **OPTICS** proposes an upgrade to the test facility presently on BM05 for consistent substrate finishing with slope control in the range of tens of picoradians.

2.1.5. Beamline control

At the user level, the principal concern for beamline control software is the handling of experimental sequences. Sequencing software combines the functionality of the different beamline components to controlled, often synchronised, operation. The software must be designed and be configurable to autonomously handle a large number of experimental scenarios. Common software functionalities necessary are:

- Abstraction of the hardware control details into a few common concepts: motor, counter, 2D detector, temperature controller, etc.
- Programming features: flow control, naming and recall of saved sequences, error handling.
- Possibility of accessing any beamline instrument from one program.
- Save data, perform basic analysis, etc.
- Provision of graphical user interfaces where appropriate.

The program providing sequencing at the ESRF is the commercial package "spec" (<http://www.certif.com/>). Network abstraction of the access to beamline instrumentation, for which different computers are in charge of several instruments, is obtained through a set of libraries and tools (Taco) that have been developed in common with the accelerator control system. The evolution of Taco (within Tango) is, nowadays, the subject of a collaboration with other European synchrotrons. The role and evolution of Tango within the Upgrade Programme is described in detail in [section 3.3.5](#).

Evolution linked to the science programme

The development of more sophisticated instrumentation requires increased support for beamline control and integration. The evolution of detectors is already imposing faster acquisition cycles and synchronisation. At the same time, the development of motor controllers and other electronics with embedded controllers multiplies the synchronisation possibilities and data sources. The configuration possibilities and the handling of data are, consequently, more complex. The Upgrade must therefore address this increased complexity. One approach will be the development of a specific

framework for fast data acquisition. This framework will take into account configuration, synchronisation and data source aspects and relay them to the scientist in the most flexible way.

Another aspect to be considered is the opportunity presented by the building of new synchrotron sources in Europe. A common project with other synchrotron facilities for an integrated beamline control platform will aim for common protocols and standards for the integration of instrumentation on one hand, and for a common beamline integration scheme at the sequencing level on the other hand. The ESRF will promote initiatives and participate in the common effort.

User interfaces to experiments will evolve to integrate new developments in the beamline graphical framework. This framework and toolkit combine the sharing of graphical developments for the different beamlines with the flexibility to customise as necessary for each experimental setup.

The strategy for online data visualisation and experiment online evaluation merits a dedicated section and it is described in detail in [section 3.3.2](#).

2.1.6. Integration

Traditionally, the areas of instrumentation mentioned above have been treated independently in a modular fashion. However, this approach is no longer valid for the new generation of instrumentation where speed, precision, reliability and functionality are a must. As a result of the extensive use of software, all of the components of an instrument are linked together in a hierarchy of nested shells that integrate the simple components into one consistent, coherent package. Integration is particularly important in the sample area, where a multitude of instruments interact (see [Figure 2.1.4](#)).

The usage of embedded software in the single component is becoming more frequent, and most of the recent ESRF electronics developments for instrumentation (MUSST, OPIOM, Icepap) include embedded processors (DSP, FPGA or CPU). All of the essential components of a future beamline will be provided with embedded software for real-time regulation, synchronisation and communication with the external shells and diagnostics.

A collaborative approach to the engineering challenges set down by the Upgrade Programme will be the key to success in the development of instrumentation for the future.

Moreover, standard procedures and controls for instrumentation development and testing will be implemented to ensure conformity with the performance objectives and requirements for reliability, repeatability and maintenance. These are the first steps that will lead to an ongoing quality policy for beamline equipment to assure maximal operational efficiency.

Figure 2.1.4: The working space around the sample is a critical area shared by a plethora of characterisation tools and sample environment devices. On one side: sample environment and positioning devices complemented by X-ray detector(s), sample viewing, optical tools and beam position monitors. On the other side: characterisation instruments that provide complementary information to the X-ray derived data. For example: scanning probe microscopes, scanning electron microscope, various types of spectrometers (UV/visible/IR, Raman). In the long term, it is possible to envisage intelligent sample holders based on functionalised nano-electromechanical systems (NEMS) that could provide a variety of information on the chemical and physical status of the sample.

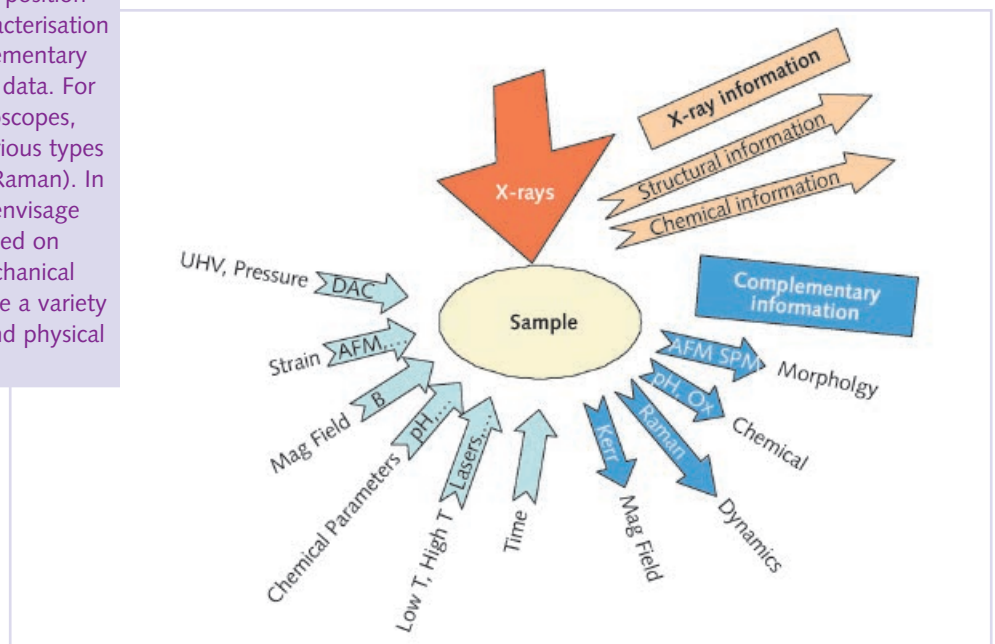

2.2. Towards nanoscale imaging

Science context

A substantial portion of the science described in Part 1 relies on imaging techniques, in most cases with a sub-micrometre spatial resolution, and with a clear trend towards the nanoscale.

In the “imaging-type” approach, quantities such as density, chemical content and state, structure, and crystallographic perfection are mapped into two or three dimensions. Nanometre-scale resolution can be achieved by scanning the sample with a nanometre focus beam, through direct imaging including phase contrast imaging, and through coherent diffraction imaging, a novel technique that exploits the partial coherence of the ESRF X-ray beam. Moreover, by pushing the temporal resolution to the sub-second scale for a complete three-dimensional image, new fields of investigation will be opened. These levels of spatial and temporal resolution are of critical importance in understanding a multitude of systems: following chemical and industrial processes *in situ* (chemical reactions), environmental processes (such as bioremediation of pollution), semi-conductors and storage media (which are starting to exploit nanometre scale structures) and imaging of biological systems (such as the internal structure and organelles of single cells). Maturing imaging at the nanoscale into a routine experimental technique is thus a key component of the Upgrade Programme.

Added value of the Upgrade

The Upgrade will address nanoscale imaging with programmes in the fields of:

- Nanometre spatial resolution (towards 10 nm).
- Beam pinning: Hardware and software to ensure that the co-location of nanosized beam and samples will be developed together with nanocompatible engineering and infrastructure (temperature and vibrations).
- Sample management: Develop handling methodology for fragile or nanoscale samples and to minimise sample radiation damage.
- Higher temporal resolution: New detectors with kilohertz framing rate.
- Structural information: combining diffraction and imaging using the coherence of the ESRF X-ray beam.
- Chemically-selective X-ray imaging: high spatial resolution fluorescence maps, or chemical state at the micrometre level using energy dispersive spectroscopy.

Enabling technology and infrastructure

Most enabling technology that is essential for nanoscale imaging will also be highly beneficial for many other types of X-ray science – Examples include improvements in mechanical and thermal stability, and focusing optics. Therefore this enabling technology is presented in [chapter 2.1](#) on general beamline engineering developments. The key technological developments necessary for nanoscale imaging are:

- *Buildings and infrastructure*: Long nanofocusing beamlines. Sample preparation and characterisation facilities in close proximity to the experimental stations are crucial.
- *Accelerator and source*: The increased flux and brilliance will aid nanoimaging, for example in the detection of trace elements.
- *Beamlines and instrumentation*: Nanoimaging and nano-analysis beamlines with their associated specific stringent infrastructure issues: mechanical and thermal stability and coherence preserving, nanofocusing X-ray optics. High sensitivity and high speed X-ray detectors. High levels of component integration will be needed for the multi-model imaging environments.
- *Computing*: Software to simulate nanofocus beamlines. Fast data reduction and storage of copious amounts of data.

Partnerships

A partnership for nano-optics is being actively pursued. The handling and characterisation of nanosamples in connection with their study at the beamlines will clearly benefit from the establishment of a nanoanalysis platform partnership.

Industry and technology transfer

The imaging beamlines already have a considerable number of industrial users. This user community is expected to grow as nanofocusing techniques become available on a routine basis. A number of technologies linked to these new techniques are the subject of licence agreements (for example, the Kirkpatrick-Baez mirror optics systems for nanofocus beams).

2.2.1. Introduction

Synchrotron radiation-based X-ray imaging is a unique tool for a wide variety of applications. This can be attributed to the extremely high brilliance of modern synchrotrons combined with the penetration power and element specificity of X-ray techniques such as scattering, absorption, and fluorescence.

X-ray imaging (all the variants of microtomography, diffraction imaging, chemical imaging) is currently a strong attribute of the ESRF. Current techniques will be pushed to the limits of their spatial and temporal resolution in order to maintain the ESRF's position as leader within this field. The ESRF wishes to play a crucial role in emerging and promising topics like coherent diffraction imaging. The best science will be produced by combining cutting-edge technical and engineering improvements together with a platform of optimised X-ray techniques and laboratories that make it possible to prepare and fully characterise a sample.

In this chapter, several scientific examples are presented to illustrate how the Upgrade Programme will open new areas of research. These are followed by technological considerations on how to ensure a stable relative position of the X-ray beam and a nanometre scale point of interest on a sample. In addition to these specific points, nanometre resolution imaging also relies on the more general technological improvements described in [chapter 2.1](#) (in particular high-performance focusing optics) and on the detector developments outlined in [chapter 2.5](#). Furthermore, the developments outlined here will aid the extension of other synchrotron X-ray techniques towards nanoscale samples.

2.2.2. Towards nanoscale imaging with synchrotron radiation

Synchrotron radiation-based X-ray imaging has a clear need for higher spatial resolution. This is required by many different scientific communities including the materials science, soft condensed matter, biology, and cultural heritage communities. Nanofocused beams and lensless coherent diffraction imaging are techniques that make it possible to achieve high spatial resolution, beyond the detector resolution. The use of phase contrast is an invaluable addition to this, not only is a source with high brilliance required but the brilliance of the beam needs to be preserved throughout the optical system to the sample. These emerging techniques are amongst those that will benefit the most from the Upgrade Programme.

The different ways to achieve nanoscale resolution in imaging are illustrated by examples. The most obvious one is to scan a nanometre-sized beam across

the sample ([Figure 2.2.1a](#)). The spatial resolution is then given by the beam size. [Examples 1](#) and [2](#) show how this technique can be used to measure the distribution of chemical elements in the sample.

Parallel beam phase contrast imaging ([Figure 2.2.1b](#)) allows obtaining a 3D density map of the sample, which can be reconstructed from several images, taken at different distances from the sample (holotomography, see [Example 3](#)). Alternatively, phase contrast imaging with a diverging beam may be used to achieve magnification images with unprecedented resolution (see [Example 4](#)). The ESRF excels in these areas.

Taking advantage of the coherence of the beam is another approach when trying to reach a resolution of a few nanometres. This is achieved in two ways, as shown in [Figures 2.2.1b](#) and [2.2.1c](#). Part b) of [Figure 2.2.1](#) corresponds to phase retrieval in the near-field regime, based on images recorded at various sample-to-detector distances (see [Example 3](#)). When using this parallel-beam technique, no image magnification

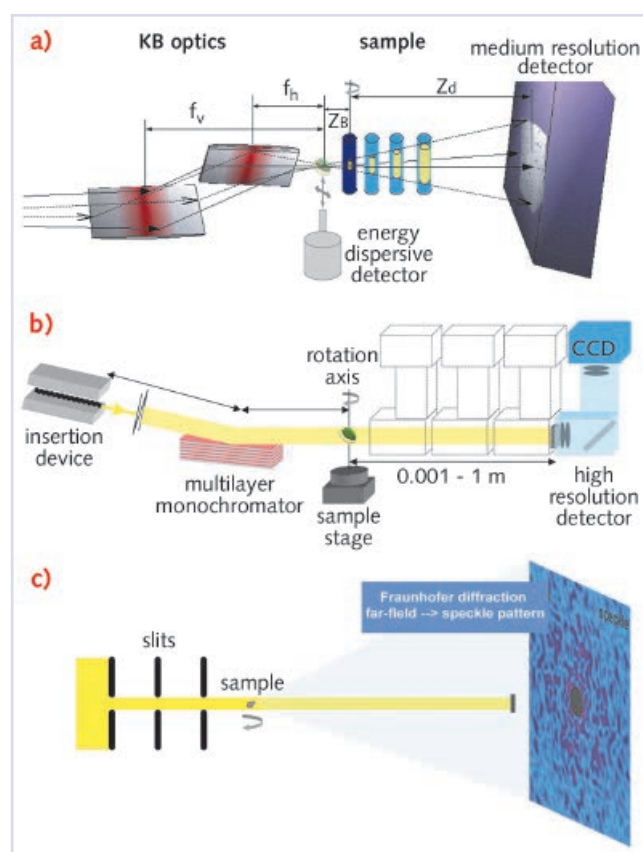

Figure 2.2.1: The various setups for nanoimaging that are foreseen at the ESRF: a) nanobeam, allowing both chemical mapping or image magnification; b) parallel beam phase contrast imaging setup used for holotomography: several images are recorded at various distances on a high-resolution detector (usually FreLoN camera, sub- μm pixel size) and combined to obtain a 3D density map of the sample; c) far field "speckle" pattern, allowing coherent diffraction imaging (CDI) to be performed.

is performed, and the detector is the limiting factor for the spatial resolution. This “holotomographic” approach can be combined with magnification (as indicated in [Figure 2.2.1a](#), and [Example 4](#)) to achieve sub-micrometre resolution.

The coherence properties of the X-rays may also be employed to go beyond the detector resolution in imaging by reaching into the far field (diffraction) regime, as indicated in [Figure 2.2.1c](#). Coherent diffraction imaging (CDI) is a lensless technique in which the far field scattering image (speckle pattern) is recorded, and the real space structure of the scattering object is reconstructed via a phase retrieval algorithm (see [Example 5](#)).

The recent extension of the materials science beamline, ID11, is a pilot project whereby the technology will be developed to make the diffraction instruments fully compatible with work at the nanoscale, whilst still enabling other length scales of interest (see [chapter 1.3](#)) to be characterised. The major part of this work involves constructing a three-dimensional detector capable of collecting data relevant to all of the length scales in the sample. The three-dimensional detector will be comprised of a series of semi-transparent two-dimensional detectors, allowing both the collection of variable resolution data and the back-projection of the diffraction signal in order to produce grain maps. Furthermore, it will enable the simultaneous collection of highly complementary tomographic data either for the characterisation of the morphological aspects of the sample (whereas the crystallographic techniques characterise the orientation, crystal structure and micro- or macroscopic strain) or for diffraction contrast tomography (Ludwig *et al.*, 2007).

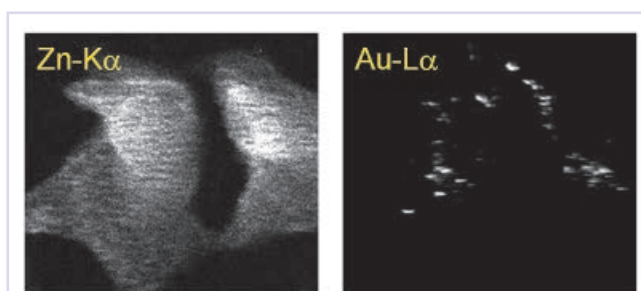

Figure 2.2.2: High-resolution imaging of freeze-dried human lung fibroblast cells incubated in the presence of 13 nm gold nanoparticles. Images show aggregates of Au nanoparticles within the cytoplasm and around the cell nucleus. Zn displays a distribution proportional to cell volume with a higher concentration within the nucleus. It is known that this essential trace element is involved in numerous protein functions in all cellular compartments. Image size: 210 x 190 pixels (H x V), pixel size 200 nm. Dwell time: 100 ms, photon flux $\sim 5 \times 10^{11}$ ph/s at 17 keV (In collaboration with Dr Kysela, *Genome Stability and DNA Repair Group, The Medical School, University of Birmingham, Birmingham, UK*).

All of these nanoscale imaging developments started as test experiments or pilot projects at the ESRF. They have developed into specific CDRs that can only be fully developed within the framework of the Upgrade Programme.

Example 1: High-resolution chemical imaging

A nanoimaging pilot project has been initiated consisting of a Kirkpatrick-Baez (KB) nanofocused high flux beam ([Figure 2.2.1a](#)). [Figure 2.2.2](#) shows a high-resolution chemical map of a cell obtained using this setup. Both the spatial resolution (given by the 80 nm spot size) and the very high sensitivity (attogram range) achieved in this pioneering and multidisciplinary project, demonstrate the feasibility of investigations at the level of cell organelles. This paves the way for new exciting scientific fields, like the study of the role of metal in the physiopathology of the cell. Other approaches are possible in imaging sub-cellular details (electron microprobe, near-field scanning microscopy, etc.). However, the deep penetration depth of hard X-rays is unique: the specimens do not have to be sectioned, and with X-ray chemical nanoscopy complete, frozen-hydrated cells are imaged at high-spatial resolution without introducing artificial dyes.

The X-ray fluorescence is induced throughout the thickness of a whole cell and can therefore be used to quantify elements on a “per cell” basis, as shown in [Figure 2.2.2](#). Elemental speciation can also be carried out by scanning the energy across an absorption edge. Only third-generation synchrotron radiation sources provide the high brilliance at high-photon energies that is required to acquire elemental maps of biological structures at subcellular spatial resolution.

The high resolution and high sensitivity chemical nanoscope (CDR SFINX) proposed within the framework of the Upgrade Programme will be optimised for this type of demand, particularly in the field of cellular targeting (cancer therapy, gene therapy, molecular imaging, etc.) and for investigating metal transport routes associated with neurodegenerative diseases. These areas are of paramount biological and medical significance. The impact of nanoprobe in biomedicine would be strengthened by the development of an integrated sample characterisation and positioning platform. This would be created with the aim of combining information from fluorescence microscopy, X-ray fluorescence elemental analysis, X-ray projection microscopy and electron microscopy.

Intense X-ray nanobeams could, however, provoke radiation damage and modifications of the sample chemistry. A widely accepted method of slowing down damage is cryo-cooling, which preserves the

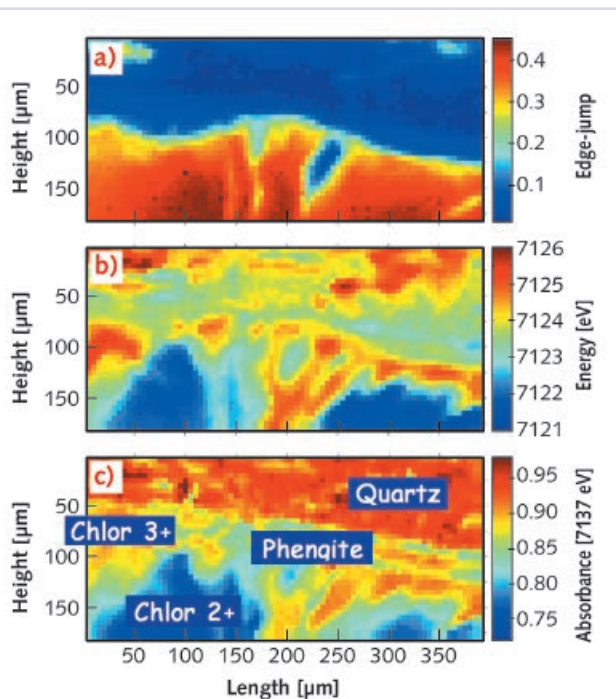

Figure 2.2.3: Chemical map of a thin slice of natural rock obtained on an energy dispersive spectrometer, around the Fe K-edge. About 3000 spectra were collected in ~ 100 minutes in fluorescence detection, with 5 μm resolution, to cover an area of about 200 \times 400 μm^2 . 2D maps of (a) iron content, (b) oxidation state and (c) speciation, were obtained by extracting values of the absorption jump, edge energy position and absorbance at a defined energy, respectively. Quantitative values of Fe redox were extracted by analysis of the pre-edge region.

native state of the sample. The available electron microscopy cryo-technology cannot be directly transferred to the X-ray world. It is therefore a high priority to develop specific cryo-environments for frozen hydrated cells in order to carry out X-ray scattering, imaging and spectroscopy techniques aiming for subcellular resolution.

Example 2: Microbeam-based energy dispersive spectrometry

Chemical imaging could widely benefit from the use of an energy dispersive spectrometer coupled with a microbeam. The advantages of such a setup, which is proposed within the framework of the Upgrade Programme (CDR EDXAS), is that it features no movement of optics during acquisition. This leads to enhanced stability of energy scale, spot size and position. This, combined with a micrometre-sized spot and the option of fluorescence detection, has made it possible to address 2D mapping with micrometre resolution on heterogeneous samples. Full XAS information on each pixel (Pascarelli *et al.*, 2006) has been provided. Figure 2.2.3 shows the results of a

first test experiment at the Fe K-edge on a natural rock thin section (Muñoz *et al.*, 2006).

This approach is a starting point for the investigation of a completely new set of scientific topics. The Upgrade Programme will allow a dedicated experimental setup to be constructed, as well as creating the tools required to obtain the best scientific results from the information collected. The data obtained are intrinsically complete but complex to interpret. Specific software is required to process the raw data before the relevant information can be visualised. This is the case for the simple oxidation state identification (from XANES), or the local structural parameters (from EXAFS). Specific software developments are therefore required for data reduction, image reconstruction and visualisation and to produce targeted and reduced XAS information on each pixel.

Example 3: Holotomographic approach

Parallel beam quantitative phase contrast imaging or "holotomography" with a high spatial resolution detector has great potential for visualising detail that cannot easily be seen by any other technique. It has already brought to light a 3D network for air circulation in seeds (Figure 2.2.4) of the model plant *Arabidopsis* (Cloetens *et al.*, 2006). This reservoir could allow rapid gas exchange for energy supply during germination. This type of experiment will be optimised on the parallel beam imaging beamline corresponding to the CDR IMPACT.

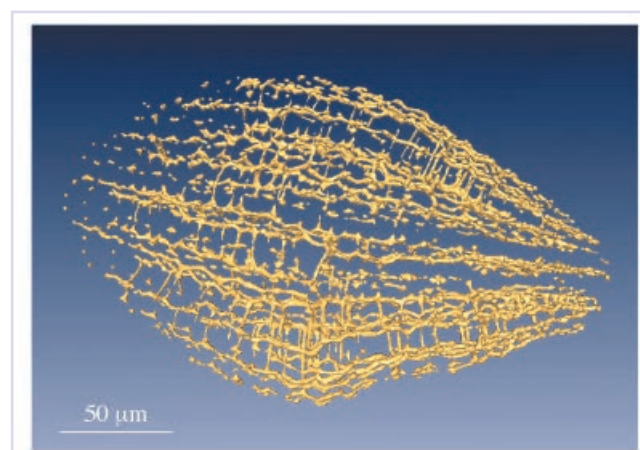

Figure 2.2.4: 3D rendering of an *Arabidopsis* seed, obtained by holotomography. The schema used was that indicated by Figure 2.2.1b, with a 0.28 μm pixel size.

Example 4: Magnified phase contrast imaging

The first results obtained through the use of the pilot project setup consisting of a Kirkpatrick-Baez (KB) focused pink beam and X-ray image magnification are

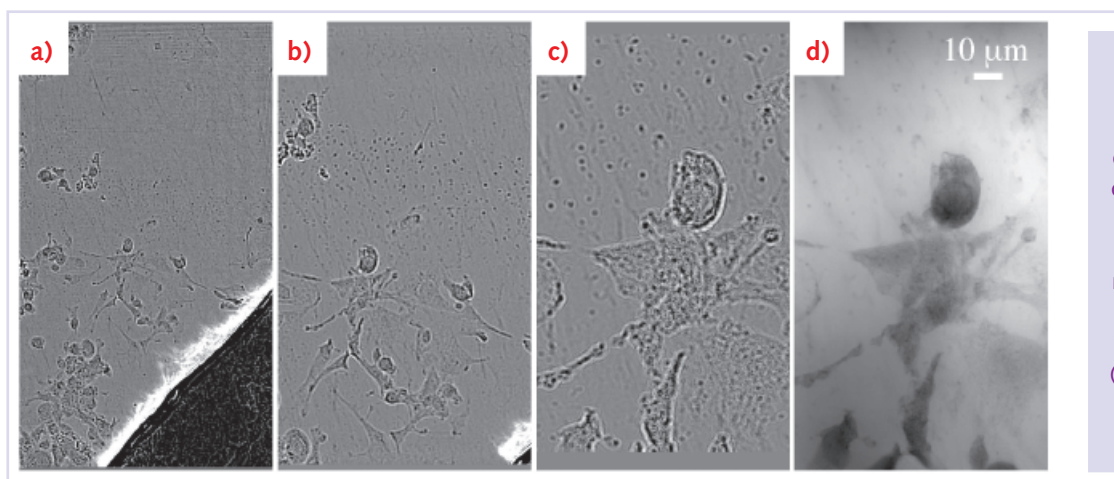

Figure 2.2.5: (a-c) Radiographs of a neuron at different distances downstream of the focus, indicated by Figure 2.2.1a, hence changing the magnification, and (d) phase image resulting from the combination (phase retrieval) of the various images recorded.

shown in Figure 2.2.5. The recorded images with different magnifications are numerically combined (phase retrieval) to obtain a magnified image displaying a pixel size of 85 nm. X-ray projection microscopy can be combined with tomography or laminography to obtain a 3D high spatial resolution image of a relevant region inside a laterally extended sample (Mokso *et al.*, 2007). This type of experiment, as well as chemical maps with very high resolution, will be developed within the framework of the Upgrade Programme in the CDR SFINX.

Example 5: Coherent diffraction imaging

Coherent diffraction requires the scattering volume and the coherence volume of the beam to be matched. In this case, a strongly modulated intensity pattern, *i.e.* a "speckle pattern", is seen in the far field due to self-interference of the scattered radiation (Figure 2.2.1c). The speckle pattern contains information about the exact spatial configuration of the scattering volume, unlike incoherent scattering where only average properties can be deduced.

One application is X-ray photon correlation spectroscopy (XPCS), which follows the time evolution of the speckle pattern (CDR XPCS-CXS). The scientific applications of XPCS to slow dynamics are described in chapter 1.2.

A second application is coherent diffraction imaging (CDI), a lensless imaging technique that aims to retrieve real space information from the speckle pattern (CDRs: CDI, MX-BIB, XPCS-CXS). In principle, the resolution is only related to the maximum momentum transfer, Q , to which the speckle pattern can be measured. The ultimate resolution is thus simply given by the X-ray wavelength. In practice, however, the resolution limit is set by the signal-to-noise ratio. The development of large, 2D detectors with low noise and high sensitivity (see chapter 2.5) is of utmost importance for CDI.

Despite recent progress in electron diffraction and optical microscopy, performing both 3D imaging with nanometre resolution of biological samples (cells, macromolecules) and strain field mapping inside small crystals is unique.

CDI with sub-50 nm resolution has already been achieved (Figure 2.2.6). Examples of its use can be found in studies of freeze-dried cells (Shapiro *et al.*, 2005), 3D composition of quantum dots (Miao *et al.*, 2006), and strain inside nanocrystals (Pfeifer *et al.*, 2006). Grazing-incidence CDI has also been demonstrated and there is exciting potential to study buried interfaces and exploit polarisation and anomalous effects in CDI.

The Upgrade Programme will make it possible for the ESRF to construct new, dedicated beamlines for coherent diffraction imaging.

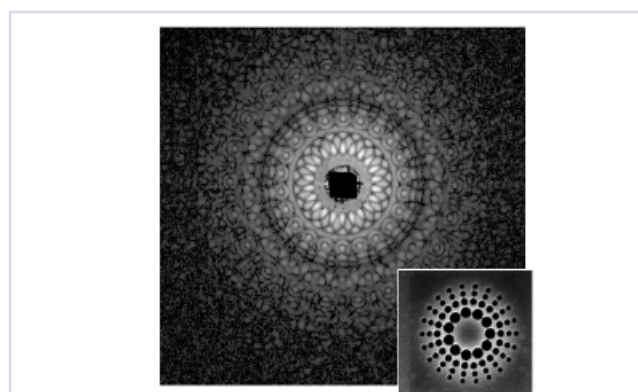

Figure 2.2.6: Coherent diffraction imaging (CDI) of the ESRF logo (made from tungsten, 3 μm diameter, SEM micrograph inset). The central part is blocked by a beamstop and the speckle pattern can be reconstructed via a phase retrieval algorithm to obtain the real space structure with ~ 25 nm resolution (data taken with coherent 7.3 keV X-rays, at the ESRF). The experimental schema for CDI is presented in Figure 2.2.1c.

Courtesy E. Lima, F. Glassmeier, F. Zontone, and A. Madsen.

2.2.3. Beam steering and sample positioning

All of the efforts to increase the performance of the ESRF X-ray light towards nanoscale beams would be pointless if it would not be possible to reliably steer and consistently keep the beam on the region of interest of the sample. Two different issues are important: monitoring and control of the X-ray beam and positioning and handling of the sample.

Beam monitoring and control

Stability of the X-ray beam remains a basic concern of any synchrotron user. The radiation source delivers powerful and stable beams, but the determining factor in ensuring their stability at the sample position lies in the engineering design of the beamlines. In the framework of the Upgrade Programme, the beam stability issue will be dealt with in an engineering programme encompassing highly optimised mechanical designs and the most advanced feedback techniques. The main goals of the programme are:

- Strict control of the dynamic response (vibration) of the optical systems from the supports upwards
- Improved thermal and acoustical stability of the hutches, cabins and optical systems
- Control of all drifting mechanisms for optical systems (such as actuator creep).

Good mechanical design is mandatory, but alone is insufficient to overcome these challenges. Beam monitoring is therefore a necessary ingredient of present and future experimental setups to integrate feedback and correction algorithms. In the Upgrade Programme, beam monitoring will not be restricted to intensity and position monitoring, but will encompass a wide range of parameters ranging from size, position, spatial profile, and timing. Monitoring the spatial profile of the beam to perform pattern recognition, for example, is necessary for applying automatic beamline alignment algorithms that will keep the characteristics of optical elements tuned to their optimum performance. Beam position monitoring has evident implications on the positional stability, but has also to be correlated with the sample position control in order to ensure that the beam stays centred on the specific detail of interest of the sample.

The present technology for beam monitoring includes systems based on scintillator/CCD and gas-filled setups, as well as thin diamond slabs or solid state ionisation chambers. All of these technologies have to be further developed to tackle the issues relevant to the Programme:

- Spatial resolution and stability in the 10 nm range
- Compact design, fitted as closely as possible to the

critical experimental beam and sample areas

- Transparent white beam position monitors insensitive to undulator gap changes.

Moreover, ESRF efforts on beam monitoring will be intensified to continue developing thin phosphor screens coupled to CCDs, diamond-free standing membranes and gas-filled beam intensity and position monitors. Beam monitoring also includes development of dedicated electronics and software, especially where fast timing and pattern recognition are necessary.

Electromagnetic compatibility is an issue with increasing importance. The burgeoning of remote handling, electronic controls, and computer links in the experimental hutches has considerably increased the levels of electronic noise. This noise level can be reduced only if particular attention is given to issues of electromagnetic compatibility.

Because so many components and the overall environment of a beamline influence its stability, the design of the new, and particularly the nanofocus, beamlines will need to integrate all the requirements for vibrational and thermal stability, beam monitoring and feedback from the inception of the beamline.

Handling nanoscale samples

For the Upgrade Programme and its many projects to study nanoscale objects, the ESRF must adopt and develop the most recent advances in sample positioning and nanomanipulation technology for use on X-ray beamlines. A large variety of engineering fields are involved in these technologies and their various functionalities need to be integrated.

As for the positioning of optical elements, many challenging issues have to be considered in this regard:

- Thermal power budget management and temperature stability
- Vibration control
- Metrology and beam monitoring for fast position feedback (beam and sample).

These issues are handled within the framework of the ESRF nanotechnology platform which was established in 2006. The platform explores the different domains of engineering in order to prepare them to be integrated on diverse beamlines. The prime role of the nanotechnology platform is to assess the performance of commercially available components. Pilot studies are already under way and are providing good reference results for components such as linear bearings and high accuracy spindles. Issues more relevant to the structure of the ESRF, like vibration

and temperature control of hutches, are taken in account by programmes of simulation and actual tests of different experimental configurations. The integration laboratory established within the nanotechnology platform must be reinforced and linked to an enlarged ESRF precision engineering team. This possibility will be offered within the framework of the Upgrade Programme, allowing a consistent set of nanocompatible instrumentation to be developed.

As for optical elements, good mechanical design needs to be integrated with new technologies for aligning samples at the nanoscale. For all of the samples that are compatible with liquid media, microfluidics is a promising technology. Its integration into the beamlines will add the possibility of handling extremely small quantities of sample, making dynamic experiments easier and offsetting the problem of radiation damage by continuous renewal of the sample.

A powerful addition to microfluidics in handling samples at the nanoscale will be the further development and integration of three-dimensional dynamic multitrap optical tweezers. The precision and ease of use of this micro/nanopositioning tool will open a new class of experiments with the possibility of automatically loading and moving samples in a given sequence and in arbitrarily defined patterns. This, again, offers a way to minimise the problem of radiation damage on biological and soft condensed matter samples for which optical tweezers are particularly adapted. Individual nanometric samples, for example, could be prepared in well aligned optical multitraps and continuously displaced on the beam.

Microfluidic and dynamic optical tweezers are ideally suited for liquid samples or ensembles of identical samples. The situation may be very different for unique or non-monodispersed nanosamples. In these samples, it is their size that defines their properties and an auxiliary technique has to be employed to identify and locate the point of interest. The information thus obtained can then be used to properly align the sample and the X-ray beam positions. For these samples, handling at the nanometre level in synchrotron radiation research may also involve movements away from substrates, straining them, compressing them, trapping them, or testing their tribological properties in the presence of the X-ray beam. All of this can only be achieved with further levels of experimentation and integration. The paragraphs below outline the future developments of a project that has already started at the ESRF aimed at the requirements of nanomanipulation and multimodal sample characterisation.

In the last three years, the ESRF has developed a variety of scanning probe microscopes that can be

integrated at the sample position and be used as beam position monitors. They can give the morphology of the surface with better than 40 nm resolution, even in the worst conditions of mechanical noise. The same device can also be used to sweep the surface, induce local stress on the sample, or, if the tip to surface distance is modulated, perform tip induced spectroscopy experiments. Figure 2.2.7 illustrates this type of development: an AFM/STM tip is used to explore the sample surface where the X-rays impinge. The tip to surface distance is kept within tens of nanometres through a feedback mechanism that is independent of the X-ray beam and is insensitive to perturbations induced by the beam. The drain current from the tip can be used to monitor the position of the X-ray beam (see inset on the right of the figure that shows the profile of the tip of the beam) and is used as input to the beam conditioning supervision system. The tip can also raster the surface to verify that the beam is consistently on top of the feature under analysis.

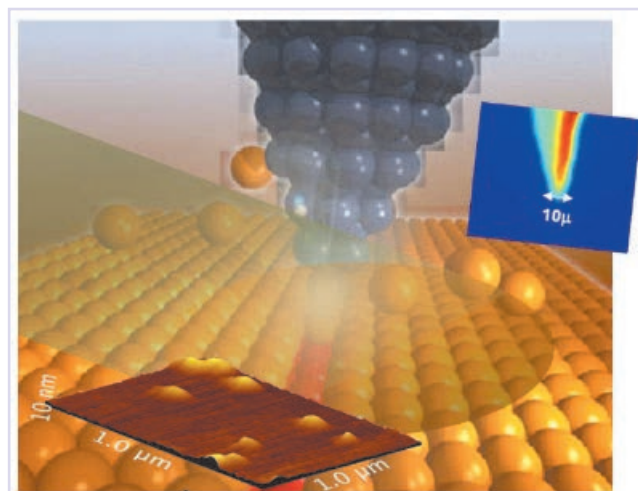

Figure 2.2.7: Scanning probe microscopy (AFM/STM) uses piezoelectrically controlled tips to probe different characteristics of the sample at the nanometre scale. At the ESRF, this technology has been used to image, at the focal plane, both quantum dots and beam position (see insets), thus making the alignment of the beam on the POI extremely convenient. The Upgrade Programme aims to further this technology for haptic manipulation of nanosamples.

The simple AFM tip described above can develop more complex functions than imaging the surface morphology and finding the beam. Extensive use of micro- and nano-electro-mechanical system (MEMS and NEMS) technology will allow nanogrippers to be developed. Figure 2.2.8 shows the functional elements of a nanogripper: two counteracting tips provided in turn with an independent haptic rendering of the forces exerted on the sample. This haptic control is an independent layer of sensors, software and actuators embedded in the beamline control hierarchy. It is believed that haptic sensing and

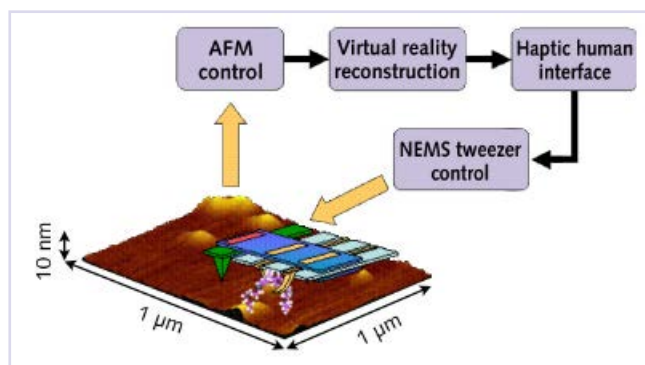

Figure 2.2.8: The concept of a nanogripper and its functional scheme: the tip of an AFM (in green) explores the sample surface in terms of morphology and rheological properties. The operator can interact haptically with the nano-objects on the surface using the two prongs of the gripper through a reconstructed virtual reality interface.

remote handling will be necessary in a large range of experimental situations.

The Upgrade Programme will give the ESRF the means to develop the laboratories and infrastructure needed to support the engineering programme for high precision sample and optics positioning. However, these concepts cannot be developed exclusively on in-house know-how and resources. It will be necessary to integrate resources on a large-scale, via EU programmes and partnerships with industry. The needs of synchrotron radiation research match many of the needs of the most advanced industry. This is the case as far as efficiency and robustness are concerned and a solid framework of interaction has to be developed and put in place.

Relevant Conceptual Design Reports:

- **CDI:** Coherent X-ray Diffraction Imaging and Microdiffraction
- **EDXAS-S/-L:** Energy Dispersive Absorption Spectroscopy (small and large spots)
- **HIENE:** High Energy X-ray Beamline
- **IMPACT:** Imaging using Parallel Beam and Computed Tomography
- **INELX:** Inelastic X-ray Scattering
- **MATSCI:** Materials Science
- **MINADIF:** Micro- and Nano-Diffraction
- **MX-BIB:** Biological Imaging Beamline
- **MX-MAD1 and MX-MICROFOCUS:** Macromolecular Crystallography using Multi-Wavelength Anomalous Dispersion and Microfocus
- **MX-MAD2:** Macromolecular Crystallography using Multi-Wavelength Anomalous Dispersion with Microfocus
- **NR-HE:** Nuclear Resonance - High Energy
- **PHIXS:** Phonon Inelastic X-ray Spectroscopy
- **SFINX:** Scanning Fluorescence and Imaging at the Nanoscale using X-rays

- **SMILE:** Spectro-Microscopy and Imaging at Low Energies
- **SURF:** Surface Diffraction
- **TRD:** Time-Resolved Diffraction and Pump-and-Probe
- **XMAN:** X-ray Spectroscopy Multi-Imaging Analysis
- **XPCS-CXS:** X-ray Photon Correlation Spectroscopy and Coherent X-ray Scattering

Key enabling technologies and infrastructures:

- **Detectors:** crucial for all imaging developments
- **Buildings:** new long beamlines, extension and optimisation of present ones, buildings for associated laboratories and partnerships
- **Computing:** to handle the large data sets, computational complexity of holographic reconstruction, phase retrieval of CDI and phase contrast images
- **Source and Accelerator:** improved brightness at high photon energies

References

- Cloetens P., Mache R., Schlenker M., and Lerbs-Mache L. (2006), Quantitative phase tomography of Arabidopsis seeds reveals intercellular void network, *Proc. Natl. Acad. Sci. USA*, **103**, 14626-14630.
- Ludwig W., Lauridsen E.M., Schmidt S., and Poulsen H.F. (2007), High resolution 3D mapping of individual grains in polycrystals by toptomography, *J. Appl. Crystallogr.*, in press.
- Miao J., Chen C.-C., Song C., Nishino Y., Kohmura Y., Ishikawa T., Ramunno-Johnson D., Lee T.-K., and Risbud S.H. (2006), Three-dimensional GaN-Ga₂O₃ core shell structure revealed by X-ray diffraction microscopy, *Phys. Rev. Lett.*, **97**, 215503.
- Mokso R., Cloetens P., Maire E., Ludwig W., and Buffière J.Y. (2007), Nano-scale zoom tomography with hard X-rays using Kirkpatrick-Baez optics, *Appl. Phys. Lett.*, **90**, 144104.
- Muñoz M., De Andrade V., Vidal O., Lewin E., Pascarelli S., and Susini, J. (2006), Redox and speciation micro-mapping using dispersive X-ray absorption spectroscopy: Application to iron in chlorite mineral of a metamorphic rock thin section, *Geochem. Geophys. Geosyst.*, **7**, Q11020.
- Pascarelli S., Mathon O., Muñoz M., Mairs T., and Susini J. (2006), Energy-dispersive absorption spectroscopy for hard-X-ray micro-XAS applications, *J. Synchrotron Radiat.*, **13**, 351-358.
- Pfeifer M.A., Williams G.J., Vartanyants I.A., Harder R., and Robinson I.K. (2006), Three-dimensional mapping of a deformation field inside a nanocrystal, *Nature*, **442**, 63-66.
- Shapiro D., Thibault P., Beetz T., Elser V., Howells M., Jacobsen C., Kirz J., Lima E., Miao H., Neiman M., and Sayre D. (2005), Biological imaging by soft X-ray diffraction microscopy, *Proc. Natl. Acad. Sci. USA*, **102**, 15343-15346.

2.3. Extended pump-and-probe techniques

Science context

Structural and electronic changes on a timescale that varies from picoseconds to seconds can be studied using pump-and-probe techniques. Dynamics down to picoseconds are studied in stroboscopic mode that relies on the various time structures available at the ESRF. Continuous wave experiments take advantage of fast detectors with a huge gain in data collection efficiency at slower timescales (ms).

The ESRF has been pioneering diffraction and scattering experiments down to 100 picoseconds. Many relevant systems, in particular in biology, produce very weak signals and low conversion rates and are thus beyond the current detection limit. The Upgrade Programme will help to access a new realm of systems that can be studied by increasing the incident flux as well as the pumping and detection efficiency.

The ESRF portfolio for pump-and-probe studies will be extended to X-ray absorption and emission spectroscopy (XAS-XES). These techniques complement the structural information obtained from diffraction and scattering experiments and furthermore give an insight into changes in the electronic structure such as oxidation and reduction processes as well as spin transitions. The approach to time-resolved XAS-XES presented here is based on wavelength dispersive optics for X-ray emission detection.

The ESRF Upgrade Programme for pump-and-probe studies is complementary to future XFELs in Europe and the USA. It covers applications that are more suitable for synchrotron sources whilst laying the foundations for pump-and-probe technology in general.

Added value of the Upgrade

The effectiveness of pump-and-probe experiments will be enhanced by the ESRF Upgrade:

- New probes (absorption and emission spectroscopy with time resolution below one nanosecond).
- Background-free X-ray absorption spectroscopy by fluorescence detection with lifetime resolution.

- SAXS option for protein dynamics in solution.
- Optimising the pumping efficiency in laser-pumped experiments.
- Extending the range of timescales that can be accessed with continuous wave techniques, through the development of faster 2D detectors.
- Extended X-ray detected magnetic resonance (with terahertz pump waves and very high magnetic fields of 30 to 40 T).

Enabling technology and infrastructure

Some of the enabling technology for these areas is referred to in the 'Added value' section above. However, other important developments for these areas include:

- *Buildings and infrastructure*: Handling of biological materials; laboratories for table-top spectroscopies (UV-Vis, IR, optical Raman, etc.) and clean room space for the laser facilities.
- *Accelerator and source*: Pump-and-probe techniques require a highly stable beam. Top-up operation will improve the stability of the machine and the optics and increase the average flux due to the reduced life time in the timing modes. Smaller source emittance and increased brilliance will make pump-and-probe experiments on very small samples more efficient.
- *Beamlines and instrumentation*: Dedicated end stations for laser pumping, including separate laser hutches. Development of X-ray emission spectrometers, in particular analyser crystals.
- *Computing*: Fast data reduction and storage of large amounts of data.

Partnerships

Close collaboration with European Molecular Biology Laboratory (EMBL) and Institut de Biologie Structurale (IBS) within the Partnership for Structural Biology (PSB).

Industry and technology transfer

A collaboration with commercial partners is anticipated for the development of spherical analyser crystals and tuneable picosecond lasers. XES end stations are planned for many national sources in Europe. Furthermore, XES also has applications for laboratory X-ray sources.

2.3.1. Introduction

Pump-and-probe techniques are used to study fast dynamics initiated by an external excitation. Diffraction studies after laser excitation were pioneered at the ESRF (Srajer *et al.*, 1996). The fastest timescales, down to 100 ps, need a maximum photon flux per electron bunch. Pump-and-probe experiments will therefore benefit from advances in high throughput X-ray optics (*e.g.* wide bandpass multilayer monochromators) and of the source (*e.g.* increased length of the straight sections, optimised insertion devices). In addition to an extension of the pump-and-probe diffraction activities, the Upgrade Programme will also develop pump-and-probe techniques in combination with X-ray absorption and emission studies. The scientific case is presented in sections 1.3.3. and 1.4.2.

The experiments are an important stepping stone towards ultra-fast experiments with femtosecond (fs) resolution at X-ray free electron laser (XFEL) sources. Despite the superior properties of the XFEL with respect to time resolution and brilliance, storage ring-based techniques are expected to retain their competitive advantage due to the greater tunability of the incident X-ray energy and X-ray pulse length for timescales of 100 ps and above. Radiation damage will be a fundamental problem at the XFEL and it is thus critical to further develop time-resolved techniques at third-generation sources in order to cover important biological applications where the high brilliance and time structure of the XFEL are not required.

At present, half a beamline, ID09B, is dedicated to pump-and-probe experiments. In the future, one full beamline could be dedicated to diffraction and scattering (CDR TRD) and, in addition, it will become possible to undertake pump-and-probe spectroscopy on ID26 (CDR XAS-XES).

The goal of synchrotron radiation pump-and-probe experiments is to study the evolution of a system such as a protein, a small molecule, a photoactive semiconductor or a material that exhibits a magnetic transition, after an external excitation. Experiments that study the shortest timescales (pico- to nanosecond range) are performed in stroboscopic mode: a process is initiated by a pump pulse that raises the energy of the sample above a threshold. The excited system then evolves, until it is probed by an intense X-ray pulse. Stroboscopic experiments therefore require temporally isolated X-ray pulses that can be selected using either a high speed chopper (Figure 2.3.1) or a detector with sufficient temporal resolution (*e.g.* avalanche photo diode, APD).

Longer timescales can be studied in the continuous wave (CW) mode, where the X-ray signal is recorded continuously after the pump pulse. This mode is

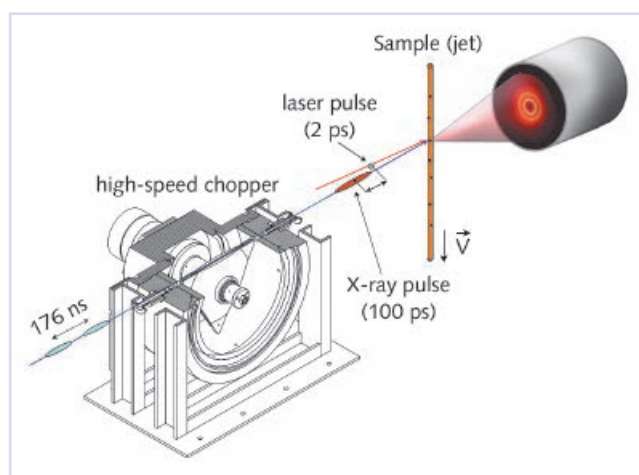

Figure 2.3.1: The principle of a single pulse pump-and-probe study of a chemical reaction in solution. A reaction is initiated by a short laser pulse and the scattering from a delayed X-ray pulse, isolated by a chopper, is recorded on a CCD detector. The experiment is repeated at up to 3 kHz.

much more efficient as a range of delay times is studied for each excitation, whereas in stroboscopic mode, only one delay time per pump pulse is recorded. The time limit for CW studies is determined by the speed of the detector. Area detectors with millisecond resolution to be developed within the Upgrade Programme (see chapter 2.5) will revolutionise slower pump-and-probe diffraction and scattering experiments such as protein folding. Detectors for spectroscopy measurements do not necessarily require spatial resolution. If the energy resolution is achieved using Bragg or Laue optics, very fast detectors can be used in CW mode.

Stroboscopic mode experiments require a temporally isolated, well-defined X-ray pulse. Hence, they rely on the time structure of the synchrotron beam and require special filling patterns. These experiments are notoriously photon starved, so it is important to optimise the incident photon flux through the use of specialised insertion devices and beamline optics, and to collect the scattered photons efficiently, for example, by using a large-area CCD detector, diode arrays or a large solid angle emission spectrometer. Improvements in all of these areas are foreseen within the framework of the Upgrade Programme.

The sections of this chapter outline the present technological limitations of pump-and-probe experiments, and how they will be alleviated by the Upgrade Programme. Improvements are foreseen in pumping efficiency, the X-ray source and beamline optics, and the X-ray detection system. Achieving temporal resolution faster than the X-ray bunch length, and new applications of the X-ray pump-and-probe technique for X-ray absorption, spectroscopy and magnetisation dynamics are all suggestions that are put forward.

2.3.2. Picosecond lasers

The majority of biomolecules work in solution at typical concentrations of one biomolecule per one thousand solvent molecules. At these concentrations, a $(0.1 \text{ mm})^3$ test sample contains about 10^{13} biomolecules. If all these molecules are to be excited with one laser pulse, the pulse must contain at least 10^{13} photons. In the past, the fastest reactions were triggered by 100 fs lasers since these lasers were commercially available and tuneable in wavelength. However, experience has shown that the high peak intensity in a 100 fs pulse with 10^{13} photons damaged the sample which therefore forced previous studies to reduce the number of photons at the cost of lowering the concentration of excited molecules (and hence the signals). Within the framework of the Upgrade Programme, 100 fs lasers will be replaced by 1 ps lasers that are now commercially available. If the damage threshold proportional to the peak intensity (ph/s), a 1 ps pulse can potentially excite 10 times more molecules. A ten-fold increase in the concentration of excited molecules will lead to a ten-fold increase in the signal-to-noise ratio in scattering experiments. The data quality will greatly improve and it should become possible to refine the atomic positions in short-lived structures for the first time.

2.3.3. Advanced hybrid filling patterns for the storage ring

Pump-and-probe experiments are complicated and require extensive beam time. The amount of beam time in the classical timing modes was limited to 35% in the past, which made it difficult to explore new techniques and carry out challenging experiments. The introduction of the 7/8 + 1 hybrid mode in March 2007 has increased the beam time available for stroboscopic experiments from 35% to potentially 80% – the remaining 20% in uniform mode is ideally suited to complementary CW experiments. In the 7/8 + 1 mode, a 2 mA single bunch is placed in the middle of a 1/8 gap in a uniform fill. The shortest time delays are probed by the single bunch, whilst for longer time delays beyond 1 μ s, the choppers will use the multi-bunch part, which has much higher intensity. A train of choppers is planned as part of the Upgrade that can vary the pulse length quasi continuously from 100 ps to seconds. By adjusting the pulse length to match the targeted time delay, the pulse intensity can be optimised, which will speed up the data collection. Note that the X-ray pulse is shorter in the 7/8 + 1 mode, 60 ps compared to 100 ps in 16 bunch mode.

2.3.4. Future insertion devices and beamline optics

Pump-and-probe experiments need a very intense X-ray beam. Extensions of specific storage ring straight sections to 7 m will allow three in-vacuum undulators to be installed on these sectors. For a time-resolved diffraction and scattering beamline, the first insertion device should be a single-harmonic undulator producing a 3% bandwidth pink beam at 15 keV for Laue diffraction with up to 1×10^{10} photons per pulse. The second one should be tuneable between 5 and 40 keV for SAXS and WAXS experiments and the third one should be cryogenic with a third harmonic at 60 keV for extreme spatial resolution. A spectroscopy beamline will be optimised to reach the absorption edges of all relevant elements, between 2.4 and 30 keV. It should be possible to operate the undulators simultaneously and the increased heat load on the optical elements will be reduced by a high power heat load chopper. Simulations show that the three undulators will produce up to 3.0×10^{10} ph/pulse at 20 keV, which is a gain of 2.5 over the present, already optimised, levels.

With the Upgrade, an updated diffraction and scattering beamline will be designed to have space for two independent monochromators operating between 5 and 60 keV: a classical silicon monochromator and a multilayer monochromator with three bandwidths 0.1, 1 and 3%. Simulations show that a multilayer focused beam from a cryogenic undulator will produce 1×10^{10} ph/s in a 1% bandwidth at 60 keV in a 3 kHz train of X-ray pulses. This unprecedented performance will enable phase transitions in large samples and in confined materials to be studied at record spatial resolution.

A typical absorption spectroscopy beamline is usually equipped with a silicon monochromator. Non-resonant X-ray emission spectroscopy, however, does not require a small energy bandwidth in the incident beam and the use of multilayer-based optics here can also bring about a more than ten-fold gain in intensity. More details on multilayer-based beamline optics are given in [chapter 2.1](#).

2.3.5. Time-resolved 2D detectors

Time-resolved pixel detectors will revolutionise time-resolved experiments. For weakly scattering samples such as liquids and glasses where photon counting is possible, the angular resolution can be relaxed compared to crystallography and the scattering patterns are comfortably recorded with a 100×100 matrix of avalanche diodes. If each pixel is equipped with a multi-channel scaler, then the scattering function $S(Q, t)$ could be measured very efficiently by

individually recording the scattering of many single pulses of X-rays around each laser excitation. In 16-bunch mode, for example, a chopper could produce a 1 μs X-ray pulse. If the laser pulse excites 100 ps before the arrival of the second pulse in the train, the first pulse will record the non-excited structure, the second pulse the 100 ps structure, the third the 176 ns structure, and the fourth the 352 ns structure, and so on. A huge advantage in time occurs because the non-excited and excited states with many different delay times are recorded quasi simultaneously around each laser excitation. The accuracy of the laser induced change $\Delta S(Q, t)$ will therefore be greatly improved.

Another interesting technology development could be an energy dispersive pixel detector. As higher X-ray energies and a wider Q range are reached, the Compton background increases. In an organic solvent at $Q = 15 \text{ \AA}^{-1}$ and 30 keV, for example, 80% of the background is inelastic and shifted in energy to 29.2 keV. If a 30 keV pixel detector with 0.5 keV energy resolution could be made, this background could be screened out electronically, and the signal-to-background ratio would improve by a factor of five. The high- Q range could be measured much more quickly and with higher precision.

Recently, pixel detectors have been used to combine spatial with temporal resolution in transmission detected X-ray absorption spectroscopy (Grunwaldt *et al.*, 2006, 2007). This application has enormous potential to monitor the evolution of chemical reactions across the catalytic reactor bed under working conditions on the millisecond timescale. With increasing detector efficiency, one can envision a pump-and-probe experiment with time resolution down to the picosecond timescale.

2.3.6. Time-resolved X-ray absorption and emission spectroscopy using pump-and-probe

Many systems that exhibit reversible electronic and structural changes after a pump pulse need to be studied at low concentrations ($< 10 \text{ mM}$). This has been identified as one of the major requirements for further development in time-resolved spectroscopy (Bressler and Chergui, 2004; Chen, 2004). The main reasons for this are:

- Sample integrity: low concentrations ensure that only the desired species are present in the sample, *i.e.* the probability for clustering is reduced.
- Naturally low concentrations: some systems, *e.g.* metalloproteins, have low metal concentrations.
- Matching the pumped and the probed volume: low concentrations bring the optical and X-ray absorption path lengths closer together.

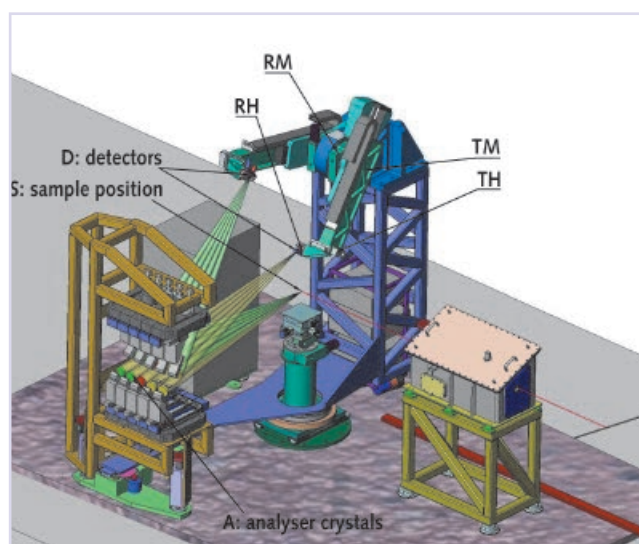

Figure 2.3.2: Large solid angle emission spectrometer with Kirkpatrick-Baez focusing mirrors. Ten analyser crystals act as monochromator and focus the emitted X-rays on two detectors. The radius can be varied between 0.5 and 2 metres.

The Upgrade will allow a beamline to be enhanced to allow time-resolved spectroscopy. The developments required are outlined below.

X-ray spectroscopy on dilute systems cannot be conducted in transmission mode and requires fluorescence detection. Time-resolved X-ray spectroscopy with possibly low conversion rates in the pump process requires good energy resolution in the fluorescence detection in order to maximise the signal-to-background ratio. Furthermore, the detection system has to be able to process count rates of several megahertz from the respective fluorescence line. In fact, the fluorescence detector must be fast enough to separate events from subsequent X-ray pulses. This is desirable even if a chopper is used for X-ray pulse selection, as in the case of slower reaction time constants ($> 1 \mu\text{s}$) subsequent bunches can be used to monitor the time evolution, which results in very efficient data collection. The optimal solution for this problem is a wavelength dispersive setup linked to a fast photon counting detector, *e.g.* an avalanche photo diode (APD).

A Bragg geometry is preferable over a Laue geometry because of the better suppression of unwanted X-ray events outside the selected energy window. A large solid angle Bragg spectrometer plus APD will give XAS data with excellent signal-to-background ratio and it will be fast enough to separate events from subsequent bunches. The radius of a Johann-type spectrometer should be adjustable in order to optimise the solid angle or energy resolution and such a spectrometer should be suitable for fluorescence detected XAS as well as X-ray emission spectroscopy (Figure 2.3.2).

Either silicon or germanium crystal wafers glued or bonded on a spherical substrate are used as analyser crystals. Covering the fluorescence energies of important $3d$ and $5d$ transition metals necessitates a minimum of 15 different types of crystals, giving a total of 150 analyser crystals for a spectrometer employing 10 analysers. Improving the silicon analyser manufacturing process, mastering the fabrication of germanium analyser crystals and the production of a large number of analyser crystals are the issues that need to be addressed in the near future.

An example of the feasibility of time-resolved XAS in fluorescence detection using a Bragg spectrometer can be found in the case of the $\text{Mn}_4\text{O}_5\text{Ca}$ -cluster in the photosystem II protein complex. This is responsible for almost all of the dioxygen content in the atmosphere of the earth. Assuming a 1 mM concentration, 10 analyser crystals with $R = 0.5$ m and the $K_{\alpha 1}$ counts per incident photon based on knowledge from previous experiments, a signal of 10^3 counts/s with 1 μs time resolution and a 3 kHz pumping frequency can be estimated. It thus becomes possible to record the complete X-ray absorption near-edge structure of the $\text{Mn}_4\text{O}_5\text{Ca}$ -cluster with sufficient time-resolution to identify electron transfer and structural changes during the biocatalytic cycle.

2.3.7. Pump-and-probe studies of magnetisation dynamics with circularly-polarised X-rays

Several approaches can be used to study magnetisation dynamics in the field of pump-and-probe techniques. In the time domain, for example, pulsed magnetic fields can be used to excite the sample. This is the case for high power microwaves in the frequency domain. The former approach is perfectly suitable for pump-and-probe experiments with timescales down to ~ 100 picoseconds. Future challenges are in implementing spatial resolution and increasing the sensitivity of such measurements. Their extension to scattering experiments will give ensemble average information. The latter method is very recent and it could be envisaged to extend the frequency range of the pump to the terahertz range in the future using the recently developed X-ray detected magnetic resonance technique. This would correspond to a timescale of 1 ps (see section 1.4.2).

High pulsed magnetic fields up to 25 T are currently feasible. Even higher fields are envisaged (~ 60 T) and new phenomena may emerge. In the future, timescales from 1 to 100 ps could be reached with faster time-resolved detectors. Fast detector schemes will open up a huge new scientific area utilising high fields and short pulses or moderate fields and longer pulses.

The proposed Upgrade will make aims pump-and-probe studies of magnetisation dynamics routine.

Relevant Conceptual Design Reports:

- PMF: Pulsed Magnetic Fields
- TRD: Time-Resolved Diffraction and Pump-and-Probe
- XAS-XES: Steady-State and Time-Resolved X-ray Absorption and Emission Spectroscopy

Key enabling technologies and infrastructures:

- New detectors are a crucial factor in the success of these new techniques (see text)
- New optics is essential for the time-resolved X-ray absorption and emission spectroscopy using the pump-and-probe technique (XAS-XES)
- Increased length of the straight sections of the storage ring will provide more incident photons

References

- Bressler C. and Chergui M. (2004), Ultrafast X-ray absorption spectroscopy, *Chem. Rev.*, **104**(4), 1781-1812.
- Chen L.X. (2004), Taking snapshots of photoexcited molecules in disordered media by using pulsed synchrotron X-rays, *Angew. Chem.*, **43**, 2886-2905.
- Grunwaldt J.-D., Hannemann S., Schroer C.G., and Baiker A. (2006), 2D-mapping of the catalyst structure inside a catalytic microreactor at work: partial oxidation of methane over $\text{Rh}/\text{Al}_2\text{O}_3$, *J. Phys. Chem. B*, **110**, 8674-8680.
- Grunwaldt J.-D., Kimmerle B., Glatzel P., Boye P., and Schroer C.G. (2007), Filming a catalyst in action, ESRF Spotlight on Science, <http://www.esrf.eu/news/spotlight/spotlight46/>
- Srajer V., Teng T., Ursby T., Pradervand C., Ren Z., Adachi S., Schildkamp W., Bourgeois D., Wulff M., and Moffat K. (1996), Photolysis of the carbon monoxide complex of myoglobin: nanosecond time-resolved crystallography, *Science*, **274**, 1726-1729.

2.4. Advanced sample environments and extreme conditions

Science context

Extreme conditions are a central feature in very diverse fields of science, for example, geophysics, catalysis, engineering and new materials, and fundamental physics. The most demanding experiments require dynamic sample environment parameters such as pressure, temperature, magnetic fields, strain and chemical reactions. Current and future avenues of research require that several of these techniques be applied simultaneously *in situ*. Examples include high pressure and high temperature (*e.g.* for planetary science and materials synthesis) or low temperature and high magnetic fields (*e.g.* heavy fermion studies with a view to understanding exotic superconductivity).

All of this information, complementary to the primary X-ray data, gives a fuller characterisation of the sample. Thus, a key area of development within the Upgrade Programme is the design, integration and use of multimodal techniques in sample environments, and to bring such sample environments, individually or combined, to synchrotron beamlines specialised in diffraction, spectroscopy and imaging techniques. Extending the length of the beamlines will make it possible to increase the working space around the sample for a given spot size, making it easier to integrate more probes and analytical systems to explore the sample.

The most extreme conditions can be generated only within a very small volume or over a very short time period. It is therefore imperative to integrate a specialised sample environment with state-of-the-art data collection using the ESRF's high brilliance and flux, new fast and efficient detectors, micro- and nanofocused X-ray beams and adapted software for data collection and online analysis.

The Upgrade will push the present limits of thermodynamic parameters and enable the routine application of extreme environments of pressure (section 2.4.2) and temperature (section 2.4.3) to samples on the beamlines. Within the framework of the Upgrade Programme, the range of standard and special sample environments available to the beamlines will be extended, in combination with other techniques (section 2.4.4).

In the last section (2.4.5) of this chapter, the project to implement static (DC) high magnetic fields in the

range up to 30 T on the ESRF-ILL site is described. This facility will make fields well beyond the superconducting limit available for X-ray and neutron scattering and spectroscopy. The development will be coordinated through the form of a European High Magnetic Field Facility, which has been put forward as a proposal within the framework of the Upgrade Programme. This will involve close collaboration between the ESRF, ILL, and European high magnetic field laboratories to make DC magnetic fields higher than 30 T available for X-ray and neutron scattering and thus create a worldwide unique facility.

Added value of the Upgrade

The Upgrade Programme will integrate sophisticated and/or extreme sample environments into the beamlines and will extend the range of environments routinely available on the beamlines. In particular, it will provide facilities for routine extreme conditions of:

- High pressures up to 1 Mbar and also at lower kilobar pressures with wider opening angles for improved X-ray optical access
- High temperatures up to and above 3000°C
- Low temperatures, extending the range available to below 1 K
- High magnetic fields up to 50 T in pulsed mode and 30 T in continuous mode

To make optimum use of these environments, they need to be integrated with specialised equipment and instrumentation on beamlines dedicated to a particular X-ray technique.

Enabling technology and infrastructure

Some of the enabling technology for these areas is referred to in the "Added value" section above. However, other important developments for these areas include:

- *Buildings and infrastructure*: Space for new infrastructure such as the DC magnetic field power supply. Facilities for off-line sample preparation and characterisation.
- *Accelerator and source*: The increased brilliance will improve the efficiency of one-shot destructive experiments that cannot be repeated (*e.g.* exothermic chemical reactions).
- *Beamlines and instrumentation*: High sensitivity and high

speed X-ray detectors. High levels of component integration will be needed for the sample environments. End-stations dedicated to DC and pulsed high magnetic field experiments. Development of high field magnets adapted to X-ray (and neutron) experiments.

- *Computing*: Fast data acquisition and handling.

Partnerships

The projects on pulsed and static high magnetic fields will be undertaken in close collaboration with several European high magnetic field laboratories and the ILL. Further contacts exist with Japanese and American groups, in particular on the topic of series connected hybrid magnets.

Industry and technology transfer

There is some potential to sell technological developments to other synchrotrons and/or other research laboratories. Examples include:

- Microtomography furnaces.
- Small-scale production of pulsed magnetic field instruments. First contacts exist with APS. The system was developed in collaboration with industrial (METIS, Belgium) and academic (LNCMP, France and GHMFL, France) partners.
- Similar interest exists for small-scale industrial production of the in-house developed low-vibration mini-flow cryostat for low temperatures.
- Sample changer for macromolecular crystallography co-developed by ESRF and EMBL and now the subject of a licence agreement.
- High pressure: An automatic pressure drive for diamond anvil cells has been developed in collaboration with industry. First contacts for a larger scale commercialisation have been formed.

Within the Upgrade Programme, numerous other systems will be developed. The ESRF will build upon these existing industrial contacts in order to make these available to the synchrotron X-ray community at large. A general problem in the commercialisation of synchrotron-specific developments is the small size of the potential market.

2.4.1. Introduction

The ESRF makes available a range of sample environments to help scientists carry out new and exciting experiments and these environments are continuously being developed and updated for new experiments. The four key areas of environment handled are high pressure, high and low temperature and high magnetic field. Each beamline, and sometimes even each experiment, requires a specific sample environment. Four main considerations need to be addressed when determining how to build the specific sample environment:

- The thermodynamic parameters to be varied (pressure, temperature, electric and magnetic fields) and their combination
- The geometry of the X-ray technique, where photon energy and opening angles dictate the construction and choice of a suitable window material
- The sample shape and phase: liquid, solid, in solution, surface, bulk, etc.
- The ancillary equipment for complementary analytical methods such as optical spectroscopy, electrical resistivity, STM, AFM or for special procedures such as fatigue, rheological treatments, chemical reactions, mixing, etc.

In the fields of geophysical research and planetary sciences ([chapter 1.3](#)), high-pressure sample environments combined with high temperatures are heavily exploited. Ancillary equipment such as a ruby luminescence spectrometer, radiation thermometer or additional optical spectroscopy can be used in parallel. However, when studying, for example, electron correlations ([chapter 1.4](#)), these high-pressure sample environments are used in combination with low temperatures. High pressure and low temperature are particularly interesting in combination with high magnetic fields. As a third example, catalysis at high temperature requires a furnace with its sample space under a controlled atmosphere (consisting of a mixture of various gases) being separated from the heater space.

2.4.2. High-pressure technology

Requests for high-pressure sample environments have significantly increased over the last few years. Originally, only one and a half beamlines were dedicated to high-pressure research. At present, five additional beamlines employ high-pressure techniques during up to 50% of their beam time. The diamond anvil cells (DACs) in use for most experiments are able to handle a few tens of μm^3 of sample up to pressures above 1 megabar. The science developed in [sections 1.3.4](#) as well as in [sections 1.4.2](#) and [1.4.3](#) will require new geometries for DACs combined with new technologies for sample confinement. As an example, the recent development of conical diamonds has

increased the available opening angles. Additionally, the use of high pressure has been extended from the traditional areas of physics and earth sciences into new areas such as soft condensed matter and biology. Consequently, more and more non-specialised beamlines need support. The list below presents areas that will be developed within the framework of the Upgrade Programme.

- **Mechanically driven diamond anvil cells for temperatures below 10 K**

The diamond anvil cells currently in use are driven by a helium gas membrane; they stop working below 10 K because of condensation of the helium. High-pressure experiments at low temperature (*e.g.* CDRs: HIPRE, MAGSCAT, NR-HE) are awaiting the possibility for *in situ* pressure variation and measurement, coupled to a lowering of the minimum temperatures available (<1 K for HIPRE) to study many interesting phenomena in physics that only occur at such low temperatures.

- **High pressure, high temperature**

High-pressure experiments at high temperatures have several options depending on the pressure range required. A large-volume press (able to manage a few mm³ of sample up to ~100 kbar) will be installed on ID06 and the development of the Paris-Edinburgh press (able to handle 1 mm³ to 200 kbar) will continue to reach larger opening angles and increase the pressure and temperature range. The prototype (as used on ID27) diamond anvil cell laser heating system needs to be transformed into a mobile system able to be integrated as required on a number of beamlines (*e.g.* CDRs: EDXAS, PHIXS). There is a large gap between the whole cell heaters capable of reaching 500°C that are currently available on most beamlines and the laser heating system that was tailored for use on ID27 and which has a minimum

temperature of 1200°C. Whole-cell and in-cell resistive heating techniques (as mentioned below for the laser machining) and adapted DACs need to be developed further to facilitate access to the medium temperature range between 500°C and 1200°C. Further developments in in-cell heating will be of particular benefit to the area of earth sciences where heating of samples is often required.

- **New diamond anvil cells**

New diamond anvil cells (**Figure 2.4.1**) need to be developed to cope with the diversification of experiment types (XMCD, scanning microfluorescence, biology, etc.). These developments aim to permit higher pressures above 1 Mbar, lower pressures down to a few kilobars, larger opening angles, perpendicular optical access and operation for lower photon energies or at high magnetic fields. A new pressure cell needs to be developed for samples that react with the pressure marker currently used (mechanics and material choice such as CuBe for high magnetic field), as well as the diamond seats (shape, size), the gasket (material, multiple holes for samples/pressure marker, built up from different materials) and the diamonds (moissanite, shape, size, hollow, double).

- **Ancillary equipment: gas loading system, laser drill, and sample manipulation**

As many experiments (*e.g.* CDRs: HIPRE, INELX, PHIXS) need to maintain hydrostatic conditions up to the highest pressures possible, helium gas loading is a necessity. The current gas loading system can only manage a single type of DAC and will have to be upgraded to an automatic system able to accept the different designs of diamond anvil cells (the cells vary to suit the various experimental requirements such as cryogenics, magnetic field, high temperature, etc.).

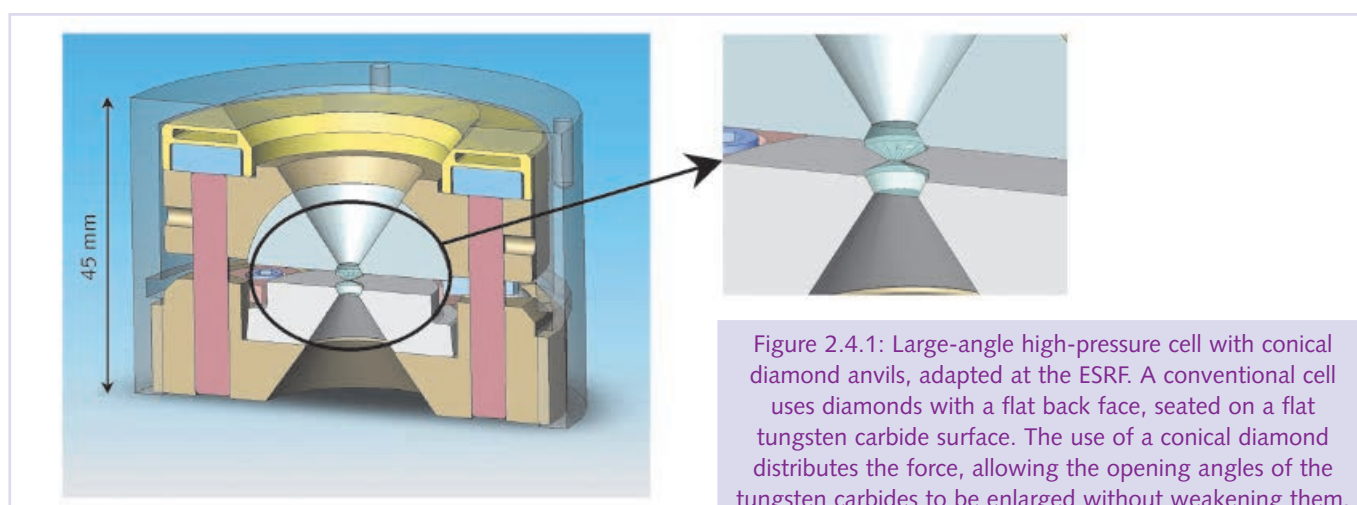

Figure 2.4.1: Large-angle high-pressure cell with conical diamond anvils, adapted at the ESRF. A conventional cell uses diamonds with a flat back face, seated on a flat tungsten carbide surface. The use of a conical diamond distributes the force, allowing the opening angles of the tungsten carbides to be enlarged without weakening them. Future developments will include machining of the backside of the diamonds to make them thinner and improve the transmission for lower energy XAS experiments.

Improvement of the laser drill installed at the ESRF is required to bring it to routine operation. Laser drilling consistently provides the small hole sizes necessary to reach the megabar range. Drilling multiple holes in gaskets will allow more samples to be loaded in a single run, thereby increasing the efficiency of experiments. In the longer term, an additional benefit of the laser drill is to provide laser machined gaskets suitable for direct electrical heating using the gasket as the heating element.

Specialised equipment is needed to manipulate and load samples of sizes below 20 μm into the sample space. Smaller focal spots will allow smaller samples to be used and therefore higher pressures to be reached. Small samples are, however, difficult to handle and tools will be needed to cut and handle micrometre-sized samples.

2.4.3. High- and low-temperature environments

Numerous techniques have been developed to create stable temperatures over a large part of the temperature range (2 K up to 2000 K). More extreme temperatures are required, for example in the study of glass transitions, which can be found in a range of temperatures from 10^{-3} K to 10^3 K, *i.e.* over six orders of magnitude. Starting at low temperatures, the steadily improving beam stability pushes the choice in favour of vibration-free gas flow cryostats, which are constructed for maximum ease of use. Around room temperature, Peltier elements offer a bidirectional temperature swing and ten times better stability than a thermostat bath. Encapsulated resistive elements allow work to be carried out up to 1000°C in an oxidising environment. The Upgrade Programme will make advances possible in the following areas:

- **Low temperature**

Today, temperatures down to 2 K can be accessed routinely on the ESRF beamlines. Cooling techniques based on the use of nitrogen and helium are well established. Gas flow cryostats are currently in favour over closed cycle cryostats because of vibrationless operation. In particular, gas flow cryostats are the only way to create a low-vibration, low-temperature environment for nanofocusing. The challenges in the field of cryogenics come from the total energy of the X-ray beam absorbed by the sample which renders access to very low temperatures especially difficult. As very low-temperature instrumentation is technically complex, key points will be integration, efficiency and user friendliness. The developments described below, within the Upgrade Programme, are required to make lower temperatures available on the beamlines.

Stability and finely controlled alignment to ensure that the X-ray spot remains pinned on the sample remains an issue to be investigated for micro- and nanofocusing (*e.g.* CDRs: MATSCI, MX-MAD1, SMILE). Moreover, the cooling power conveyed and the temperature measurement on a focal spot of size 20 x 20 nm² are wholly new territories that will need to be managed within the Upgrade Programme. The eventual goal is to enable routine <2 K cooling for such experiments.

Low temperature and sample movement (*e.g.* phi rotation, xyz scanning), with cooling below 10 K (*e.g.* CDRs: RIXS-PES, SMS) under UHV or with exchange gas. The two options are to create a moving stage able to carry a cryostat, or fix the cryostat and create the movement inside. The latter is the only option when a sample in a cryomagnet or pulsed magnet has to be rotated to orient crystal directions with respect to the beam and magnetic field. The similarity with MX-MAD1 and MX-MAD2 should be pointed out, where the present in-air setup (using cold nitrogen gas streams) cannot be maintained with the extension to low X-ray energies to reach the sulphur and phosphorus edges. The challenge here for the Upgrade Programme is to combine automatic sample changing in a low X-ray absorption environment also compatible with sample cryogenics.

The other axis of cryogenic development is to gain access to below 1 K temperatures. As the thermal boundary resistance between sample and substrate increases with decreasing temperature, it becomes increasingly difficult to evacuate the heat deposited in the sample by the X-ray photons. Methods must be developed to perform efficient sample cooling at temperatures below 1 K for the synchrotron radiation environment.

One type of experiment demands the development of a large-capacity ³He circulating cryostat able to reach sub-1 K temperatures with high cooling power and capable of routinely handling large mass apparatus (such as DACs) and/or high beam powers (*e.g.* CDRs: HIPRE, MAGSCAT, PMF) eventually in conjunction with high pressure and magnetic field (*e.g.* CDRs: MAGSCAT, NR-HE). On the other hand, the development of synchrotron radiation-compatible techniques using a dilution refrigerator will allow access to temperatures below 100 mK for relatively few experiments (*e.g.* CDRs: HIENE, NR-HE). The challenges to overcome are the X-ray optical access which needs to be small to minimise heating by ambient radiation and the transfer of cooling power to the sample. For high-energy nuclear resonance experiments, the combination of mK cooling with high pressure (200 kbar) has a high potential for exciting scientific results.

- **High temperature**

A general trend for higher temperatures is evident in

many of the Upgrade Programme's scientific areas (*e.g.* CDRs: EDXAS, EMS, EXAFS, HIENE, INELX, MATSCI, NR-HE, NR-NSM, PHIXS, SMILE, XAS-XES). At the same time, higher temperature furnaces are required to cope with the diversification of experimental techniques. Unlike neutron science, where many experiments can be undertaken using a single furnace geometry, different synchrotron radiation techniques demand different geometries. Radiation losses increase with the fourth power of the temperature and thus large X-ray opening angles (*e.g.* CDRs: INELX, PHIXS, XAS-XES) put even more constraints on the structure, window material and temperature difference between heater and sample. The Upgrade Programme will address this challenge and will aim to enable routine access to temperatures greater than 1400°C using electrical heating for these open configurations.

Other requirements for new high-temperature furnaces within the Upgrade Programme are the reduction in size and thermal inertia, relief of strain from electrical leads, alternative heating mechanisms, new inert materials and constructions to separate the heater from the sample space coupled with control of the sample atmosphere. High-temperature and nanofocusing environments (*e.g.* CDRs: SMILE, MATSCI) will require exceptional spatial stability to maintain the beam pinned on the sample. This is similar to the case of cryogenics, mentioned above. Space around the furnace is needed for focusing devices and detectors (see [Figure 2.4.2](#)). The challenge lies in making these modular and flexible furnaces available on a standard everyday basis using resistive, microwave or inductive heating techniques. The latter will allow metallic samples to be studied at temperatures up to 3000°C. Samples heavily interacting with their environment require the use of a sample floater, which, in combination with a laser heating system, permits temperatures up to 2500°C to be reached in order to study ceramic materials at high temperature. Laser heating can only be used for smaller samples (less than a few mm³) compared with electric heating.

2.4.4. Other developments

Optical techniques: spectroscopy and laser heating

Time-resolved techniques already use laser pumping (see [section 1.3.3](#) and [chapter 2.3](#)). Two further areas have been identified that are required for the Upgrade Programme:

- Multimodal complementary experiments using UV/visible/IR and/or Raman (micro)spectroscopies as complementary methods are increasingly required (*e.g.* CDI, EDXAS, HIPRE, HISAXS, MINADIF, NR-NSM, SMILE, XAS-XES). The experience gained from the systems used, for example, on ID24 and the MX beamlines, will be used to build spectroscopic systems to be transported routinely to multiple beamlines and combined with adapted sample environments.
- Extension of laser heating, enabling higher temperatures (between 1500°C and 3000°C), to more beamlines (*e.g.* CDRs: EDXAS, EMS, INELX, MATSCI, PHIXS).

Other developments: nanotechnology, microfluidics, chemistry

Nanotechnology can help to integrate complementary techniques around the crowded sample space. The development of MEMS and NEMS allows concepts such as "lab on a chip" to be developed, whereby specifically functionalised electromechanical nanodevices make it possible to measure and control essential parameters of the sample: temperature, pH, humidity, viscosity, etc. Other sample environment developments required are:

- Microfluidics for soft condensed matter samples allowing control of various parameters such as pH, temperature, mixing, etc. (see [section 1.1.3](#) for examples).
- Chemistry/catalysis cells for following wet and dry chemistry *in situ* at varying temperatures (from 150 K to greater than 1000°C) and pressure (see [section 1.3.3](#) for more details and examples).

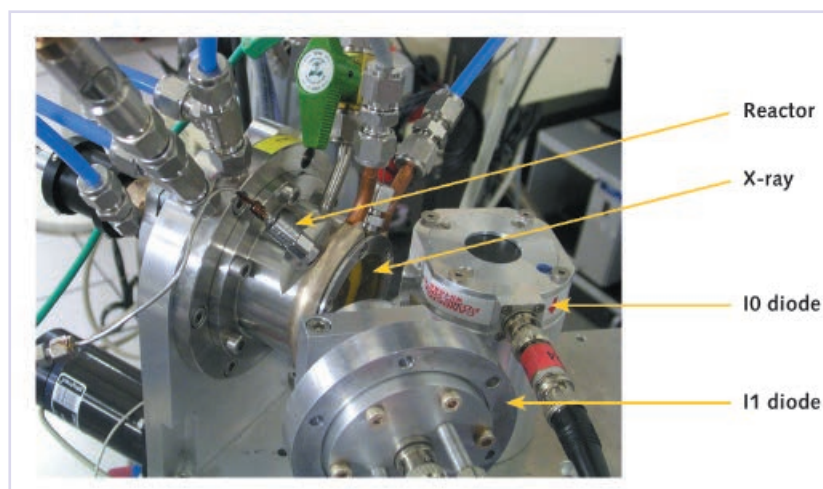

Figure 2.4.2: Catalysis furnace capable of 800°C, used for turbo-XAS fluorescence experiments on the ID24 dispersive beamline. It is less than 10 cm in size and features a large X-ray opening angle and temperature stability of 0.1°C. The very small sample volume is physically separated from the in vacuum heater to reduce the reaction time. One of the future developments in high temperatures is to maintain this separation whilst increasing the maximum temperature to 1200°C.

2.4.5. High magnetic fields

High magnetic fields are one of the most powerful tools available to scientists for the study, modification and control of the state of condensed matter (Herlach and Miura, 2003). The magnetic field acts independently on the orbit and spin of the particle. These two degrees of freedom control the collective properties of condensed matter through correlation effects and the magnetic field can therefore be used to change the balance of the correlation effects and thus investigate and/or modify these properties. The modification often leads to phase transitions, many of which have already been identified in numerous research laboratories dedicated to high magnetic fields. The higher the field, the larger the number of transitions to new fundamental states of matter that can be observed. The most recent examples of new effects driven by high magnetic fields are transitions to a quantum critical point, field induced superconductivity in quasi 1D-organic conductors, and the interplay between magnetic and electric properties in multiferroics. A prominent example for quantum criticality, URu_2Si_2 , has already been described in [section 1.4.2](#). Another system being closely monitored for insights from X-ray experiments is the quasi 1D-organic conductor $\lambda\text{-(BETS)}_2\text{-FeCl}_4$, which displays changes of the macroscopic properties in its low temperature ground state as the magnetic field is increased. The zero-field antiferromagnetic insulating phase is suppressed by application of a magnetic field. The sample first becomes metallic and eventually shows a superconducting phase, where the external magnetic field compensates for the exchange field of aligned Fe^{3+} ions. These two new phenomena occur in the presence of external magnetic fields in the range of 20 to 45 T and illustrate how the magnetic field affects the charge or spin and orbital degrees of freedom leading to novel states of matter. The problems of interest in high magnetic fields are not limited to correlated electron systems and cover a large range of topics in contemporary condensed matter physics, materials science, chemistry and even biology.

There is often a long delay between identifying a macroscopic phase transition and understanding its microscopic properties. Nearly all available techniques for studies of materials in high magnetic fields larger than 15 T are restricted to macroscopic methods, such as magnetisation, transport and thermodynamics, optical and microwave-based spectroscopies. These cannot yield information on the microscopic properties of the system, which are vital when understanding the electronic interactions that drive the phase transitions and their relation to the static and dynamic structural properties of the system. Over the last few decades, synchrotron radiation techniques have matured into the most suitable tools to provide access to these microscopic

properties as they directly probe the charge, spin and orbital degrees of freedom (see [chapter 1.4](#)). The very high brilliance, polarisation state and time structure result in synchrotron X-rays being able to be used for a large variety of cutting-edge spectroscopy and scattering techniques to explore the aforementioned effects in various complementary ways. In particular, these techniques are the tools of choice to study the structure, static and dynamics of the electronic and magnetic properties at a microscopic level. Their shell and element specificity renders these spectroscopies even more attractive as a means to probe the electronic and magnetic interactions, and to understanding more thoroughly the mechanism that governs the observed macroscopic properties.

The highest steady magnetic field currently available for experiments at synchrotron radiation facilities is only 15 T. This is in operation at Spring-8 (Japan). A 13 T superconducting magnet for scattering experiments is also available at the Advanced Photon Source (APS) (USA), whilst the highest magnetic field at the ESRF is provided by a 10 T superconducting split-pair magnet. There is currently a rapidly growing interest from the synchrotron radiation user community in a facility that combines X-ray absorption spectroscopy and X-ray scattering experiments with higher magnetic fields.

High magnetic fields beyond the superconducting limit (at present ca. 18 T for solenoid magnets, and 15 T for split-pair magnets) can be generated by two complementary techniques:

- Pulsed magnetic fields are generated by capacitive discharge. The ultimate achievable field (including X-ray applications) lies in excess of 60 T, well beyond the highest steady field available worldwide. First prototype experiments have already been carried out at the ESRF. The technique has the intrinsic disadvantage of a very low duty cycle, limited by the cool-down time of the load coil (*e.g.* one 30 T pulse of about 30 ms (FWHM) per 3 minutes) and is therefore only useable for X-ray techniques yielding large signals.
- Steady (DC) magnetic fields up to 33 T and 45 T can be achieved using purely resistive or resistive-superconducting hybrid magnets, respectively. Steady fields are needed for X-ray techniques that require very good statistics (and thus long data collection times), such as X-ray magnetic linear dichroism. This is also the case for X-ray techniques that have intrinsically low count rates, such as inelastic X-ray spectroscopy and resonant and non-resonant magnetic X-ray scattering. This need is underlined by the fact that many systems of interest have strongly quenched magnetic moments, and thus only very small magnetic signals. An example of this can be found in many of the heavy fermion systems that undergo phase transitions of unknown nature.

The strong interest in simultaneously developing pulsed and steady (DC) high magnetic fields is demonstrated by the sheer number of such projects worldwide (see, for example, Committee on Opportunities in High Magnetic Field Science, 2005). The proposed 45 T steady high magnetic field scattering facility in the USA is an example of this. It will be built through a partnership between university researchers, the Advanced Photon Source (APS) at Argonne National Laboratory (ANL) and the National High Magnetic Field Laboratory (NHMFL). Pulsed magnetic field projects are under way both at SPRING-8 and at the APS.

The ESRF Upgrade Programme creates a unique opportunity to combine the state-of-the-art X-ray techniques developed and perfected at the ESRF with high magnetic fields in excess of 30 T. New science will be enabled through the exploration of the microscopic properties of novel states of matter.

In the remainder of this section, the specific scientific cases are introduced for pulsed and DC high magnetic fields. The challenges in magnet design and other technical aspects are then described. Organising the pulsed and DC high magnetic field projects and creating potential partnerships to do this are also discussed.

Pulsed magnetic fields

Any realistic theoretical model of a correlated electron system in a high magnetic field must be based on knowledge of the atomic arrangement because the different interactions strongly depend on it. The determination of the correct crystal structure is thus a prerequisite for validating any model of the ordered state and the underlying interactions. The importance of such structural studies is further reinforced by the observation of anomalies in the ultrasound velocity and dilatometry at magnetic field induced phase transitions.

X-ray scattering has, until very recently, only been combined with moderate static magnetic fields, despite the fact that it is the dominant method for the determination of crystal structures. Within a relatively simple setup that does not require movements of the sample during data acquisition (except for improving the powder average), it is possible to determine the space group, lattice parameters, and angles, and to estimate atomic positions within the unit cell. First demonstration experiments on BM26 and ID20, in collaboration with the Laboratoire National des Champs Magnétiques Pulsés (LNCMP, France), have been carried out with great success using a stroboscopic method where an image plate detector is exposed only near the maximum of the magnetic field pulse. Significant improvements in the efficiency and

data quality of the experiment will be achieved by replacing the detector by a 2D system with a frame rate in the order of 1 kHz (see chapter 2.4).

An example can be found in the magnetisation plateaus in low-dimensional $S = 1/2$ systems. The magnetisation process of low-dimensional quantum spin systems with spatial structures such as spin ladders, exchange-alternating chains and dimers, are new problems in magnetism and do not yet have a theoretical grounding. For many of these systems, it has been predicted that the magnetisation is not a uniform function of the applied magnetic field, but rather tends to form plateaus where the magnetisation is quantised to a fractional number of the total magnetisation. These plateaus have been observed in the dimer chain compound NH_4CuCl_3 and in the 2D highly frustrated spin dimer $\text{SrCu}_2(\text{BO}_3)_2$ (Kageyama *et al.*, 1999). There is recent evidence to show a discontinuous phase transition in $\text{SrCu}_2(\text{BO}_3)_2$ from a uniform magnetisation to a modulated superstructure near 27 T, with a magnetisation plateau at 1/8 of the full magnetisation. The possibility of a lattice distortion at the plateaus is strongly supported by ultrasound experiments, in which sharp softening of the elastic constants is observed in high fields.

One of the questions that will be addressed in this project is the nature and magnitude of the atomic displacements occurring at the magnetisation plateaus in 2D quantum spin systems like $\text{SrCu}_2(\text{BO}_3)_2$ and NH_4CuCl_3 . These powder diffraction studies in pulsed magnetic fields will make it possible to directly determine the superstructure using resonant X-ray scattering off single crystals in DC fields.

Two disadvantages intrinsic to powder diffraction also favour the development of single crystal diffraction: (a) the comparatively low signal-to-noise ratio does not allow magnetic scattering to be detected and (b) in powders, the magnetic field is applied along a random direction, a significant inconvenience for samples that exhibit strong magneto-crystalline anisotropy and phase diagrams that depend on the direction of the applied magnetic field. It is expected that, in favourable cases, superlattice reflections will be able to be studied directly due to magnetic or orbital order using X-ray resonant scattering. The K-edges of 3d transition metals, however, exhibit only small resonances, and the resulting weak signals require long data acquisition times, which can only be undertaken with DC field installations, as described below.

Other X-ray techniques that may be combined with pulsed magnetic fields include X-ray magnetic circular dichroism (XMCD), and nuclear resonant forward scattering (NRFS). First proof-of-principle experiments have been carried out on ID24 and ID18, respectively.

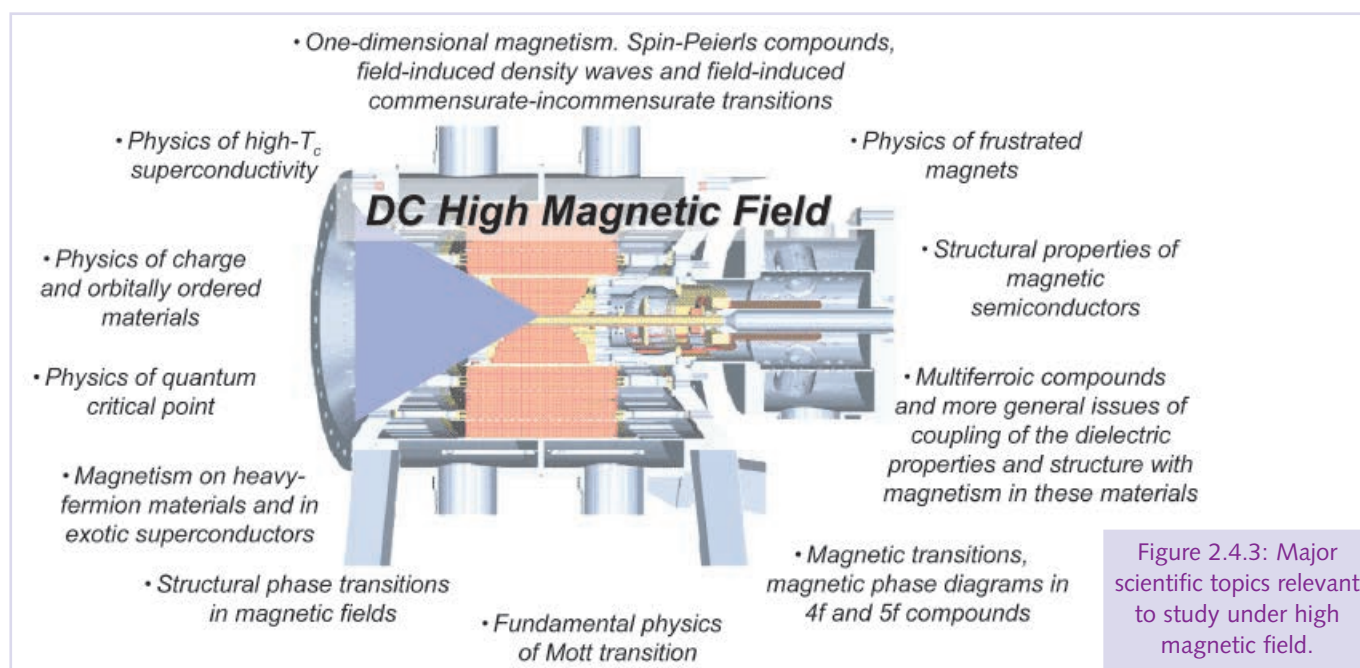

As demonstrated above, fields in the order of 30 T have already been implemented at the ESRF, and extending the technology up to ~50 T can be carried out in a fairly straightforward manner. However, this requires a larger generator, which can reasonably be implemented only in a fixed installation on a dedicated end station (see CDR PMF). Prototypes of split-pair coils for magnetic fields up to 40 T, needed for single crystal diffraction, are already under development at the LNCMP. Both miniature coils for stored energies in the kilojoule range and standard coils for energies up to 1 MJ in straight solenoid and split pair configurations need to be optimised for synchrotron use. Specificities are increased life span and faster cooling whilst problems of reliability and stability have to be solved. Further development is needed of X-ray compatible flow cryostats which are insensitive to both magnetic field and variation of magnetic field (which causes eddy currents and consequential heating). Extending the temperature range to below 1 K is also planned. In the longer term, the development of miniature mechanically clamped high-pressure cells would allow the exploration of phase diagrams in all of the (p , B , T) space.

The pulsed magnetic field activities at the ESRF could become one aspect of the partnership between the ESRF, ILL and the future European High Magnetic Field laboratory (see below).

DC magnetic fields

Resistive or hybrid DC magnetic field systems are not subject to the restrictive duty cycle intrinsic to pulsed magnetic fields. This, in principle, makes it possible

to combine them with all X-ray techniques available at the ESRF today – in particular, techniques with very low count rates or small signal-to-noise ratios that require the high brilliance and stability of the ESRF and cannot be carried out elsewhere.

Scientific goals include obtaining structural information together with static and dynamic electronic and magnetic information at a microscopic level on diverse classes of materials. This covers a wide range of topics in contemporary condensed matter physics, materials science, chemistry and even biology. Element and orbital selective information provided by X-ray absorption spectroscopy and scattering would be very helpful in unravelling the role of each element in the magnetic interactions that govern the macroscopic properties.

The major relevant scientific topics to study under high magnetic fields are presented in [Figure 2.4.3](#). In all of these topics, the microscopic origin of the observed macroscopic properties is not yet clearly understood. For instance, the role of spin and orbital paramagnetism on the reappearance of superconductivity and on the physics of quantum critical points needs to be further developed. In metamagnetic and magneto-elastic transitions, the behaviour of the orbital magnetism (which is intimately coupled to the lattice) across those transitions is poorly understood. The latter effects are typically present in rare-earth or actinide-based compounds exhibiting several distinct field-induced magnetic phases. Magnetic fields as high as 30 T may be required to reach their ferromagnetic ground state (*e.g.* DyAg presents four distinct field-induced phases below 40 T). The modification of the density of states of phonons with high magnetic field via

magnetostriction is a topic that has been completely unexplored. Under high magnetic fields, paramagnetic systems (*e.g.* Pauli and Van Vleck type) will become measurable using X-ray absorption techniques. This is particularly interesting for superconductors in which huge diamagnetism prevents the paramagnetic response being studied using any standard method. X-ray absorption can be highly useful in understanding the mechanism of magnetic field-induced superconductivity. The role of spin and orbital paramagnetism on the reappearance of superconductivity and on the global physics of quantum critical points can be elucidated. The atomic orbital anapole moment that is directly related to parity non-conserving interactions in magnetic systems has recently been detected at the ESRF. The influence of high magnetic field on the orbital anapole is currently a new field of research that needs to be explored.

An extremely important example that needs to be considered for study, including all phenomena shown in [Figure 2.4.3](#), is the strong magnetoelectric coupling in multiferroic crystals such as ReMn_2O_5 (where Re = rare earth). These systems provide an unprecedented opportunity to manipulate ferroelectric polarisation using magnetic fields. From a technological point of view, the mutual control of the electric and magnetic properties is an extremely attractive concept for spintronic applications. However, most investigations to date have been limited to a rather low magnetic field region. Recently, high magnetic field (B) versus temperature phase diagrams of DyMn_2O_5 in magnetic fields up to 45 T and temperatures below 50 K have been determined from the dielectric constant, pyroelectric, and magnetoelectric current measurements using various magnets: superconducting magnets up to 17 T, a DC resistive magnet up to 33 T, and a mid-pulse magnet up to 45 T. The phase diagram reveals that at least four different kinds of ferroelectric domains, which show strong temperature and field history dependence, develop at low temperatures below 40 K, and exhibit dramatic evolution under B . For example, as B increases at 4 K, ferroelectric polarisation shows successive flopping at $B = 2, 7$ and 22 T, producing unprecedented large changes of the dielectric constant of 5, 70 and 20%, respectively (Kim *et al.*, 2005). Such a complex phase diagram was first interpreted in terms of strong spin-lattice coupling that is linked to the exchange interaction between Dy f and Mn d spins. Later on, it was discovered that such large changes are associated with an unusual commensurate-incommensurate magnetic transition. This extraordinary effect appears to originate from the high sensitivity of the incommensurate state to external perturbation. It seems that ferroelectricity appears to originate from the competing magnetic interactions that cause ferroelectric lattice modulation through magnetoelastic coupling.

The origin of the ferroelectricity in such novel materials is still unknown. X-ray absorption spectroscopy and X-ray scattering together will bring new insight into the appearance of the different ferroelectric phases under high magnetic fields.

The ESRF uses state-of-the-art X-ray spectroscopies and scattering tools that allow the microscopic properties to be probed under high magnetic fields of matter. This should cover all major scientific research areas cited above. The best suited X-ray-based techniques that are compatible with DC high magnetic fields are:

- **X-ray magnetic circular dichroism (XMCD) and X-ray magnetochiral dichroism (XM χ D)**. These X-ray absorption spectroscopy techniques are directly sensitive to the magnetism of the sample. They allow the static spin and orbital magnetism, and orbital anapole moment to be probed (respectively).
- **X-ray detected magnetic resonance (XDMR)**. This technique was pioneered at the ESRF ID12 beamline (Goulon *et al.*, 2005) and allows the spin and orbital magnetisation dynamics to be probed separately using XMCD for samples excited under high power microwave. For microwave frequencies in the terahertz range, a high magnetic field is necessary to satisfy the resonance condition. This would give access to ferromagnetic and antiferromagnetic resonance (AFMR) detected using XMCD. XMCD is not sensitive to antiferromagnetism and therefore XMCD detected AFMR is the best way of probing the dynamics of the different sublattices in antiferromagnetic systems.
- **X-ray magnetic scattering (XMS)**. This technique is used to probe the periodic long-range order of magnetic moments and orbital multipoles directly. The applied magnetic field may induce changes in the sample such as the superstructure unit cell, or the magnetic moment direction.
- **Nuclear forward scattering (NFS)**. This technique is sensitive to the magnetic exchange field and quadrupolar order at the site of the Mößbauer isotope, the latter via the electric field gradient. Nuclear inelastic scattering (NIS) may be used to examine the partial density of states as a function of the applied magnetic field.
- **Inelastic X-ray scattering (IXS)**. This technique allows the phonon dispersion to be studied in condensed matter at momentum transfers, Q , and energy transfers, E , characteristic of collective atom motions. The determination of the phonon dispersion, or more generally, of the high-frequency (terahertz) collective dynamics, gives access to various material properties such as sound velocities, elastic constants, interatomic force constants,

phonon–phonon interactions, phonon–electron coupling, dynamic instabilities and relaxation phenomena.

- **Magnetic Compton scattering (MCS).** This technique measures the spin polarised momentum distribution of the sample. Comparing the integrated spin signal to the total magnetisation allows the ratio L/S of orbital to spin magnetisation to be determined, *e.g.* in Sm , where several J-multiplets occur in close proximity.

These are the most obvious examples that can be highlighted. However, there is enormous potential for growth beyond the fundamental physics of condensed matter, including possible applications for the synthesis of new materials, and implications in soft matter and biology. The pulsed and DC magnetic field projects will create a research programme at the ESRF that brings together synchrotron radiation techniques and European know-how in producing and exploiting high magnetic fields and operating a high magnetic field installation. The potential of this unique opportunity was confirmed by leading European and international researchers present at the “Workshop on Synchrotron Applications of High Magnetic Fields”, held at the ESRF in November 2006.

Challenges, magnet design and technical aspects

Combining synchrotron X-rays and DC high field magnets is a new scientific field, but new technological aspects linked to this field also have to be taken into account. Creating such an installation poses many challenges, which can be divided into three main groups:

- Magnet design
- Power infrastructure
- X-ray beamline design and construction.

In the following, we briefly outline the problems and possible approaches used in resolving them.

a) Magnet design

The design of resistive or even hybrid magnets for X-ray applications is a completely new field and requires extensive development work. First feasibility studies are currently being carried out in collaboration with the ILL and the GHMFL. The project team is also in contact with HMI and NHMFL, which are currently designing a 35 T horizontal field hybrid magnet for neutron scattering.

It is proposed to implement two separate high magnetic field stations, which will be dedicated to polarisation-dependent X-ray absorption spectroscopy and to X-ray scattering experiments. The two

magnetic field configurations will be optimised for the X-ray experiments they are dedicated to:

- 1) The optimal configuration for X-ray absorption spectroscopy is a solenoid magnet with a horizontal magnetic field (**Figure 2.4.4**). On both sides, a wide conical angle is necessary to insert a large detector for experiments where the fluorescence signal is collected in backscattering geometry and/or in transmission geometry. This magnet will be designed to offer at least 35 T with a horizontal bore of 34 mm parallel to the field direction. It will be based on existing 24 MW/34 T resistive magnets with a 34 mm bore diameter. X-ray magnetic circular dichroism (XMCD), X-ray magnetochiral dichroism (XM χ D) and longitudinal detection of XDMR with terahertz pumping would be the main experimental techniques.

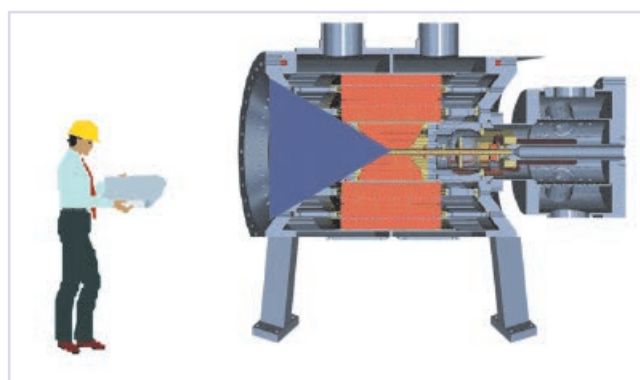

Courtesy of Sylvie Labbe-Lavigne and Francois Debray (CNRS/GHMFL Grenoble)

Figure 2.4.4: Schematic view of a solenoid-type magnet.

The conical access for on-axis scattering experiments provides additional hydraulic and mechanical constraints for the design. Conical access on both sides (not represented in the figure) will be considered in the design study. For a given power, the study will aim at defining the loss of magnetic field related to the conical access to the magnetic centre.

- 2) The optimal configuration for X-ray scattering experiments is a split-coil type magnet with vertical magnetic field (**Figure 2.4.5**). This magnet will be designed to offer at least 30 T with a vertical bore of 34 mm parallel to the field direction, a split space of 20 mm in the horizontal direction and the largest feasible optical access angle within the horizontal plane. The possibility of a take-off angle of about 10° is highly desirable in order to have access to as large a reciprocal space as possible. This magnet needs to be as flexible as possible regarding sample environment and sample alignment. X-ray magnetic scattering (XRMS) and inelastic X-ray scattering (IXS) will be the main experimental techniques.

In the first stage, both magnets will be based on resistive technology. At present, this technique offers the best reliability and lifetime, and the technological lowest risk of failure. Ultimately, in the longer term, these resistive magnets could be inserted in a

Courtesy of Sylvie Labbe-Lavigne and Francois Debray (CNRS/GHMFL Grenoble)

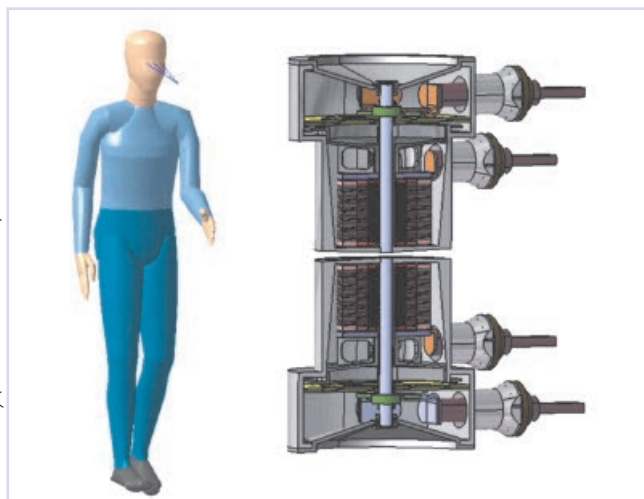

Figure 2.4.5: Schematic view of a fully split pair magnet. The volume of the sketched magnet could accept an electrical power of 24 MW. A 32 MW magnet should be larger. Such a high field split pair magnet has never been built anywhere in the world. The pre-design study aims at validating the concept of two half magnets that make up the split pair magnet for diffraction studies.

surrounding large bore superconducting magnet using Nb_3Sn cables. The resulting hybrid magnet would offer a maximal field of about 8 T higher than that produced by the resistive magnet alone. However, hybrid (in particular series-connected) magnet technology is still far from being fully developed, and significant progress is needed before the additional complication of X-ray compatibility can be envisaged.

The magnets cannot be installed inside the existing experimental hall due to their size for the necessary power requirement, cooling water connection and for safety reasons. The "Vercors" extension

(see chapter 3.2) has been suggested as the proposed location, which is optimally situated as far as sharing parts of the infrastructure with similar installations at the ILL is concerned.

Figure 2.4.6 shows the case of the split-coil magnet with its associated environment. It can be noted that the integration of such a magnet into a beamline requires a special infrastructure design to accommodate the magnet itself, the X-ray detection system, electric and cooling pipes (from bottom and top) and sample environment (top-loading insertion).

b) Power infrastructure

The main technical challenge lies in the implementation of a specific infrastructure capable of delivering electrical power of about 40 MW on a continuous basis and a corresponding cooling power using a water intake from the nearby Drac river or directly from the groundwater. The technical and administrative feasibility of this infrastructure is currently under study, in collaboration with the ILL and a consortium of European high magnetic field laboratories including the Grenoble High Magnetic Field Laboratory (GHMFL – Grenoble, France), the Laboratoire National des Champs Magnétiques Pulsés (LNCMP – Toulouse, France), the High Field Magnet Laboratory (HFML – Nijmegen, Netherlands) and the Hochfeld-Magnetlabor Dresden (HLD – Dresden, Germany). EU funding for this feasibility study has been requested through FP7/ESRFI.

c) X-ray beamline design and construction

The High Magnetic Field station dedicated specifically to X-ray absorption spectroscopies (magnet design with a horizontal magnetic field, see

Figure 2.4.4) and to X-ray scattering (magnet design with a vertical magnetic field, see Figures 2.4.5 and 2.4.6) will be installed on beamlines ID08 and

Courtesy of Sylvie Labbe-Lavigne and Francois Debray (CNRS/GHMFL Grenoble)

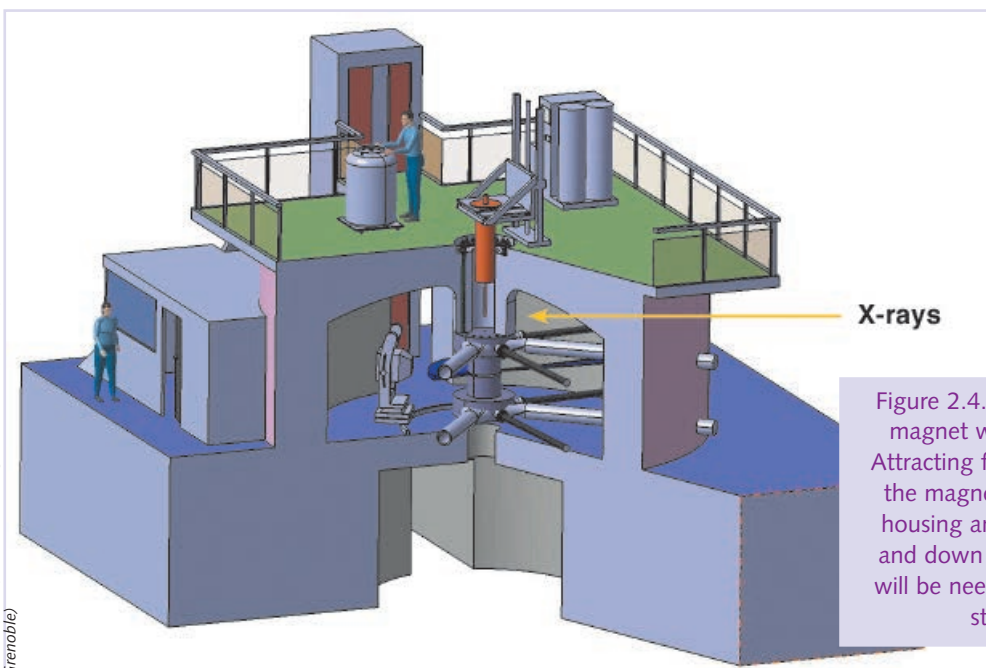

Figure 2.4.6: Schematic view of a fully split magnet with its associated environment. Attracting forces between the two halves of the magnet will be transmitted to the coil housing and must be looped in the ceiling and down the pillars. External consultation will be needed to determine the supporting structure of the building.

ID06. In both cases, an experimental hutch must be specifically designed to contain the magnet itself and to allow enough space around the magnet to accommodate the electrical and cooling system, diffraction arm and detectors and sample holder system. Those two beamline locations have been chosen to be as near as possible to the power infrastructure. Moreover, those two beamlines will have an available surface of at least 100 m².

In addition to the synchrotron-based research program, a parallel development programme will be launched to design specific detectors that are insensitive to magnetic field and sample environments adapted to such extreme conditions.

Partnership and organisation

The 40 MW power assumed in these conceptual studies represents about four times the power currently consumed by the ESRF. It will therefore represent a sharp increase in the electricity costs, even if the High Magnetic Field (HMF) installation would only operate for four to six months per year. The use of DC magnetic fields is not only attractive for X-ray investigations but also for neutron investigation. This was emphasised during several workshops dedicated to HMF research, organised by the NHMFL, Tallahassee, APS, ILL, and the ESRF, etc. The high construction and operational costs call for investigating the possibility of a common High Magnetic Field facility shared between the ESRF and the ILL. This potential for collaboration emphasises even further the positive impact installing such a HMF facility will have on the ESRF and ILL site. The proximity of the two institutes, makes it possible to build this high field facility between the two sites, in order to share the investment and running cost of such installations. The main objective is to reach, in continuous mode, fields over 30 T in special magnet configurations, optimised for X-ray and neutron experiments.

The aim is therefore to create a European Magnetic Field Laboratory (EMFL) specialised in DC high magnetic fields. It will also be open to pulsed-field development, and should remain complementary to the 100 T pulsed magnetic field project in Dresden (Germany). The EMFL will bring together the expertise of the different laboratories mentioned above at the ESRF-ILL site and eventually the expertise from other on-going projects such as the 25 T hybrid magnet project at the HMI (Berlin, Germany). This is a strategic opportunity for Europe to maintain its internationally competitive position, especially in view of the similar projects being planned in the USA (APS and SNS) and in Japan (SPRING-8).

The EMFL could be a world-class high magnetic field facility with a unique capability in performing advanced neutron and X-ray investigations on the effect of high DC magnetic fields on condensed matter. This new facility would welcome all of the international users seeking to perform neutron or X-ray experiments under high static magnetic fields. A partnership has to be established with the major European high magnetic field facilities (see above) covering technical and scientific aspects, in order to serve the European user community in an optimal fashion. The possibility of including additional partners, either from the high field community or from the neutron/X-ray community, will be considered. A specific organisational structure for the new facility will be elaborated to give optimal access to the best research proposals for high field scattering experiments.

An EMFL facility combining the highest static magnetic fields with a high-flux neutron, as well as a high-flux synchrotron source and macroscopic and local microscopic probes, would be absolutely unique in the world and would have an enormous synergetic influence on science in Europe.

References

- Committee on Opportunities in High Magnetic Field Science (2005), *Opportunities in High Magnetic Field Science*, Solid State Sciences Committee, National Research Council, the National Academic Press, Washington, DC.
- Goulon J., Rogalev A., Wilhelm F., Jaouen N., Goulon-Ginet C., Goujon G., Ben Youssef J., and Indenbom M.V. (2005), X-ray detected magnetic resonance at the Fe K-edge in YIG: Forced precession of magnetically polarized orbital components, *JETP Lett.*, **82**, 696-701.
- Herlach F., and Miura N. (2003), Editors, *High Magnetic Fields: Science and Technology*, World Scientific.
- Kageyama H., Yoshimura K., Stern R., Mushnikov N.V., Onizuka K., Kato M., Kosuge K., Slichter C.P., Goto T., and Ueda Y. (1999), Exact dimer ground state and quantized magnetization plateaus in the two-dimensional spin system SrCu₂(BO₃)₂, *Phys. Rev. Lett.*, **82**, 3168.
- Kim K.H., Kim T.H., Haam S.Y., Hur N., Park S., Cheong S.-W., Jo Y.H., Park J.-G., and Migliori, A. (2005), High magnetic field phase diagram of multiferroic DyMn₂O₅ up to 45 T, American Physical Society, APS March Meeting, March 21-25, 2005.

2.5. X-ray detector developments

Science context

Science at the ESRF and other synchrotron radiation centres is being restricted by the limitations of the detectors currently available. In many cases, these limitations reduce the overall efficiency of the experiment as they generate a significant waste of the photons in the incident beam. In other cases, the detectors are simply not able to provide all of the information required about the sample. In practice, both of these factors occur at the same time and the shortcomings of the detectors impose severe restrictions on the experiments. Scientific results may then suffer.

Developing new X-ray detectors is compulsory if the “detector handicap” is to be overcome and will generate a high added value and substantial progress in all scientific domains. The ESRF will undertake the detector development programmes in partnerships and collaborations. Furthermore, the ESRF will seek to join ongoing projects.

Added value of the Upgrade

As part of the Upgrade, the ESRF plans to put into practice a comprehensive set of detector programmes to enable new science. These cover six key areas:

- High-sensitivity large-area detectors to improve detection of micro- and nanodiffraction or ultra-SAXS from biological or fragile matter such as proteins and fibres.
- High efficiency sensors to improve detection rates, especially for high-energy X-ray experiments.
- Fast imaging cameras to enable the recording of dynamic processes using techniques such as ultrafast X-ray microtomography which require fine time slicing in the sub-millisecond range and large detection areas.
- Time-resolved hybrid pixel counting detectors combining ultrafast, nanosecond, temporal resolution with 2D recording to follow rapid processes such as liquid crystal orientation switching.
- Pixel detectors with extended dynamic range to significantly enhance experiments such as SAXS and grazing-angle diffraction where scattered intensities vary over many orders of magnitude.
- Energy dispersive 2D detectors, for example, to

greatly speed certain spectroscopic measurements and remove unwanted background from diffraction experiments.

The first two areas will result in significant improvements to existing detectors whilst the last four areas are more concerned with future devices with capabilities far superior to those that exist currently. Novel detectors will be created using combinations of these six developments.

Enabling technology and infrastructure

This chapter presents an overview of the types of detectors that are required and outlines the central lines of development made possible by the Upgrade, along with examples that illustrate how the scientific programme will benefit from advances in this field. It addresses both how existing and emerging detector technologies will be improved, as well as different approaches that could be employed to develop features not available in current detectors. The implementation of the Upgrade detector programme is also described, alongside the detector programmes, suggestions for collaborations, standards, software and integration.

Detector developments require significant long-term investment and an in-house team of highly skilled technicians and engineers. The Upgrade Programme will reinforce the current ESRF capabilities and expertise, particularly in the area of microelectronics which is crucial for the development of new detectors.

Partnerships

As detectors become more sophisticated, more resources are required in order to develop more advanced instruments. These complex projects cannot be carried out by individual laboratories. Furthermore, the “detector handicap” is common to all synchrotron radiation facilities. The ESRF detector strategy will be oriented towards promoting or participating in on-going joint development programmes, involving other European synchrotron radiation facilities, detector development laboratories and detector manufacturers. This approach will also include collaboration on a worldwide scale.

Education

The development of detectors provides an ideal opportunity to train the next generation of skilled detector technicians and engineers for the ESRF and elsewhere.

Industry and technology transfer

The area of detector development is ripe for collaboration by putting the detector development laboratories and manufacturers into contact with the synchrotron community.

2.5.1. Introduction: the detector handicap

Detector performance is a limiting factor in most synchrotron radiation experiments. Reduced efficiency occurs when the totality of available photons are not effectively used in the experiments, indeed a significant fraction of them are simply wasted. Samples may then be subjected to unnecessary irradiation, which is a severe problem for fragile, X-ray sensitive samples such as biological material or experiments at very low temperatures. Often the detectors lack some fundamental features required by the experiments. These include the pixel size and active area of the detector, its maximum spatial, temporal or energy resolution, or its sensitivity and dynamic range, which are not adapted to obtain the information required from the probed sample. In all cases, detector performance restricts experimental possibilities and the quality and quantity of the science produced at the ESRF are subsequently affected in a negative way.

Current limitations can be illustrated by the example of hydrogen in the multi-megabar regime near the metallisation pressure. This is one of the main goals in high-pressure research. **Figure 2.5.1** illustrates the diffraction pattern of hydrogen, which is dominated by a huge background comprising a significant component of Compton inelastic scattering from the

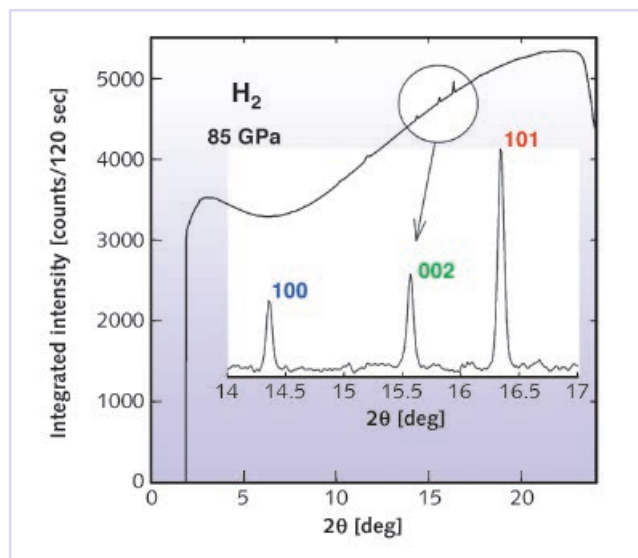

Figure 2.5.1: Diffraction from hydrogen at extreme pressure recorded at ID09 at 85 GPa (upper curve). Only the three main reflections of the hexagonal close packed (hcp) structure are observed over the background in a pseudo powder pattern after integration of a two-dimensional image (inset). The diameter of the sample was 60 μm and it becomes considerably smaller at 150 GPa, making it more difficult to extract the useful diffraction signal from the background. The study of metallic hydrogen will only be possible with more advanced detectors than those currently available.

diamond anvils (see [section 1.3.4](#)). The various super-lattice structures cannot be determined directly using current detectors because the very small signal is not detectable or is buried in the background. A complete study requires high-energy X-ray diffraction detectors with large area, high uniformity and low noise, as well as high spatial resolution and dynamic range. Energy discrimination will reduce the background and modulated structures will then be able to be determined. Temporal resolution will allow dynamic properties to be studied. An enhanced detector will lead to a much better understanding of the properties of highly compressed hydrogen, as well as hydrogen-like quasi-crystals and super-lattices and other crystallographically challenging materials such as glasses and nanoparticles. These could be measured up to very high momentum transfer, which is currently not possible.

Any attempt at improving the “detector handicap” should first look into the causes behind it. Producing better X-ray detectors is very difficult technically; current detectors are already very sophisticated instruments and further improvements have to take into account physical detection and technology limits. Furthermore, the definition of target specifications is a challenge in itself, as the diversity of experiments makes it difficult to specify detectors that satisfy several applications. Detector requirements often change even for the same type of experiment when the nature of the sample changes or when the experimental technique evolves due to improvements in methodology or beamline instrumentation.

The rapid increase in the number of storage rings and the advent of fourth-generation X-ray sources mean that there will be enormous common benefit if the development projects are coordinated through a collaborative effort among facilities. A priority in the medium and long term will therefore be to initiate and support a common strategy on detectors at the European level. A plan common to all participating facilities should be elaborated and implemented in collaboration with detector manufacturers and

development groups. A complete detector strategy has to focus both on development as well as considerations such as how detectors will be customised to different applications, how they will be produced and how support will be ensured. Some of these considerations are presented in [section 2.5.8](#), which introduces more practical aspects of the detector programme.

The subsequent sections in this chapter present the development criteria that have been identified as being central to the ESRF detector programme:

- High sensitivity large-area detectors
- High efficiency sensors
- Fast imaging cameras
- Time-resolved hybrid pixel counting detectors
- Pixel detectors with extended dynamic range
- Energy dispersive 2D detectors.

The first two development criteria, presented in [sections 2.5.2](#) and [2.5.3](#), will significantly improve existing detectors and extend their current capabilities. The remaining [sections 2.5.4](#) to [2.5.7](#) are more future-oriented. Features will be implemented on the detectors of the future that are currently not possible on the two-dimensional detectors used today. These include access to microsecond and nanosecond time domains, a combination of spectroscopy and high spatial resolution and the possibility of recording signals with single photon sensitivity and extremely strong diffraction peaks simultaneously in the same image. This will influence the way many experiments are conceived and performed today and open the path to a completely new spectrum of scientific possibilities.

The following sections introduce each development criterion by presenting a few selected examples that illustrate the scientific benefits that will be offered by the future detectors. Some of the scientific examples will also require improvements to detector features other than those that they illustrate. This reinforces how important it is to converge the different detector capabilities into the same device, the ideal X-ray detector.

| | | |
|----|---|---------------------------|
| I1 | High sensitivity CCD detectors | Indirect detection |
| I2 | Very fast imaging cameras | |
| I3 | High-resolution scintillators | |
| P1 | Diversification of hybrid pixel detector technology | Hybrid pixel detectors |
| P2 | Small pixel hybrid detectors | |
| P3 | Pixel detectors with microsecond time resolution | |
| P4 | APD-based pixelated detectors | |
| P5 | Pixel detectors with extended dynamic range | |
| P6 | High-Z semiconductor sensors | Energy-resolved detectors |
| E1 | Energy dispersive 2D detectors | |

Table 2.5.1. List of the detector development programmes.

The development criteria of the first sections are the basis for the definition of the development programmes that are presented in [section 2.5.8](#) (see also [Table 2.5.1](#)). These fall into three groups of indirect detection (I1–I3), hybrid pixel detectors (P1–P6), and energy-resolved detectors (E1). Some of the programmes aim at constructing full detector systems, whereas others are limited to partial aspects or components of detectors such as sensors or technology that are relevant or challenging. These challenging aspects will subsequently be integrated in complete detectors. The final detectors will optimise the different requirements of the target applications, whilst taking into account the limits dictated by technological and financial constraints.

2.5.2. High-sensitivity large-area detectors

Many cutting-edge scattering experiments in a wide range of synchrotron radiation applications require

large detection areas with high spatial resolution to be combined with single-photon sensitivity. Examples include micro- and nanodiffraction experiments involving biological and soft matter specimens such as single cells or fibres that are particularly sensitive to X-ray irradiation. In these cases, the radiation damage is severe due to the high photon flux density on the sample. These new techniques will make it possible to study natural crystals such as proteins that crystallise spontaneously *in vivo* within the cramped microenvironment of the cell (Coulibaly *et al.*, 2007). These crystals have a biological role that could be investigated *in situ* on a beamline. Unfortunately, the current generation of detectors cannot fully exploit the extremely weak diffraction signals from such crystals within their limited lifetime in the beam ([Figure 2.5.2](#)). New detectors should provide single photon sensitivity per pixel with negligible noise and an active area large enough to collect the complete diffraction pattern. Given the small size of the incident beam and the crystal, a high spatial resolution that matches the width of the diffraction spots is necessary to extract the diffracted signal from the background.

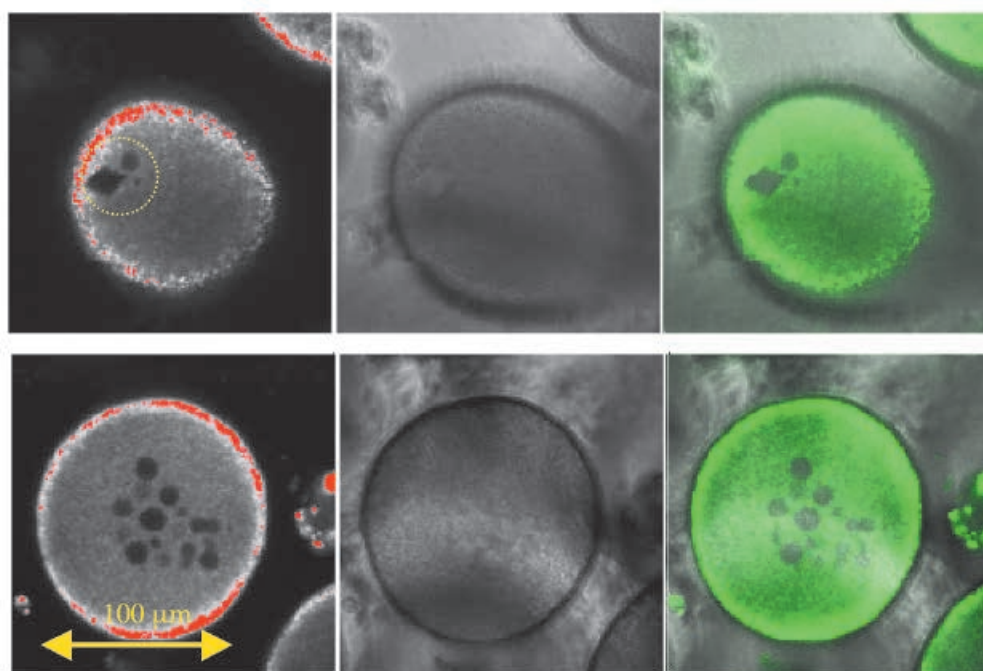

Figure 2.5.2: Top: Autofluorescence microscopy shows natural protein microcrystals (encircled, maximum size 20 µm) within living oocytes of 120 µm diameter. Bottom: Harvested cryo-vitrified natural protein crystals (encircled) from which only a few diffraction images can currently be recorded before the sample gets damaged by the focused beam. High sensitivity detectors will allow data sets that are complete enough to provide structural information to be collected.

Another example of an experiment that requires large detection areas with high spatial resolution and single-photon sensitivity is ultra-small-angle X-ray scattering (USAXS). In conjunction with SAXS, it can be used for the non-destructive elucidation of hierarchical structures, from the nanometre to micrometre scale, in materials which are optically opaque (see [chapter 1.2](#)). Developing this technique critically depends on the availability of detectors. It also requires high angular resolution, which is primarily limited by the spatial resolution of the detector, and high sensitivity and dynamic range as the scattered intensity varies over many orders of magnitude. One of the proposed developments within the framework of the Upgrade Programme involves combining USAXS and imaging techniques (see [chapter 1.2](#)).

One of the outstanding developments in muscle research using high brilliance X-ray sources is the observation of interference fine structure in active single fibre diffraction patterns (Linari *et al.*, 2000). This has made it possible to follow angstrom-scale motion of the force generating myosin molecules during muscle function, as well as to reproduce structural kinetics. Further exploitation of interference fine structure in single fibre muscle diffraction depends on the availability of a detector that has both high resolution and high sensitivity. These studies involve X-ray scattering experiments with fine control over the mechanical and biochemical states at the single cell level (sarcomere) using demembrated fibres. These experiments will provide answers to many longstanding questions concerning the coupling between biochemical reactions and structural changes associated with force development in muscle. High detector sensitivity is crucial because the single fibre diffracts weakly and is susceptible to radiation damage. Time resolution capabilities are also required as the structural changes occur on millisecond and sub-millisecond timescales.

Detector technology

CCD-based detectors and the emerging hybrid pixel technology are the two main choices at the present time for the construction of large-area detectors with very high sensitivity.

The large majority of two-dimensional detectors used at synchrotron radiation facilities are based on CCD technology. More than 90% of the area detectors used at the ESRF employ this technology; the ESRF's own FReLoN camera is a good example of this. The best combination of high sensitivity and dynamic range and large active area is obtained with detectors that use fibre optic coupling to transfer the light pattern from a phosphor screen to the CCD. This technology is already very advanced, although there

is a continuous evolution in the quality of CCD sensors and substantial progress is being made in features like quantum efficiency, pixel well capacity and active area. The larger sensor area allows the highest coupling efficiency to be maintained. However, this high efficiency is compromised by a trade-off with the stopping power of the conversion phosphor for the sake of higher spatial resolution (Phillips *et al.*, 2002). The high quantum efficiency in recent devices is a contributing factor when reaching the point whereby the resulting detector sensitivity permits discrimination at the single photon level above the noise floor. The characteristics and robustness of CCD detectors ensure that they will continue to be used in synchrotron radiation research for many years to come.

Hybrid pixel detectors are devices that combine the high quality of sensors made of high resistivity (mainly silicon) semiconductors, with a readout scheme in which every pixel has its own processing electronics channel. This massively parallel processing and readout is made possible by the availability of highly integrated specific microelectronic circuits. The readout integrated circuits are bonded at the back of the pixelated sensors with an individual connection per pixel. Most current detectors designed for synchrotron radiation and imaging applications like PILATUS, XPAD and MEDIPIX, have energy discrimination capabilities and operate in photon counting mode. These detectors therefore provide negligible noise and, subsequently, a very large dynamic range.

These features make pixel detectors highly attractive for a large range of scattering experiments and their use will most probably become widespread in the future (Broennimann *et al.*, 2006). There are, however, features of the current detectors that have not been assessed in their totality. Radiation hardness is, for example, a crucial characteristic that may mean that they are less used in experiments in which the detector receives high irradiation doses. Reducing the pixel size and the number of defective pixels limiting the dead areas to a minimum are also important improvements that must be addressed in future developments. The sensors and the readout scheme implemented in current counting pixel detectors have intrinsic limitations such as poor energy resolution or their restriction to relatively low intensities due to the counting mode operation. The development of improved sensors and readout architectures will overcome some of those limitations (see [sections 2.5.5 to 2.5.7](#)).

The detector programmes foreseen in [section 2.5.8](#) study the development of large area detectors based on both CCD (I1) and hybrid pixel technology (P2). Both address the same applications but are complementary to each other due to their differing

levels of technological advancement. In the medium term, they should therefore be developed in parallel. CCD cameras can be designed and built in a relatively short time with moderate resources. The developments will focus on devices with higher sensitivity and smaller pixel size than current cameras. Hybrid pixel detectors, on the other hand, even if not yet well established, offer exciting new features and an enormous potential. Therefore, a specific development programme (P1) is envisaged to encourage the development and diversification of hybrid pixel technology.

2.5.3. High-efficiency sensors

Detector efficiency is a crucial parameter in any synchrotron radiation experiment. As introduced in [section 2.5.1](#), any significant reduction in the efficiency of the detector is equivalent to an effective waste of photons. Experiments that are photon-limited require nearly 100% detection efficiency. This limits the choice of the detector and therefore the experimental possibilities. The use of position-sensitive detectors with single-photon sensitivity has, for example, proven to be extremely useful in enhancing the energy resolution in studies of low-energy electronic excitations with high-resolution inelastic X-ray scattering techniques (Huotari *et al.*, 2005). Pixel detectors operating in photon counting

mode are excellent for this application. However, currently available sensors based on silicon are only fully efficient up to roughly 10 keV. To make this type of detector suitable for phonon and vibrational spectroscopy (see [section 1.4.3](#) and [Figure 2.5.3](#)), the detector has to guarantee nearly 100% efficiency up to typically 30 keV.

Higher detector efficiency is also fundamental when extending the high-energy microdiffraction capabilities into the small angle region in order to obtain information about the long range order in nanoparticle arrays or superlattices. These efforts are described in [section 1.3.5](#) and require special 2D detectors to be developed for high-energy SAXS/GISAXS. The detectors should demonstrate improved efficiency for detection of hard X-rays without any loss in spatial resolution. Furthermore, at high energy, the Ewald sphere becomes almost flat and, with the proper detector, the reciprocal space can be sampled without detector or sample movements. This will enable, for example, many truncation rods to be measured simultaneously and structural changes could be analysed on the sub-second timescale.

Nuclear resonance scattering is another example of when detector efficiency is crucial. Experiments rely on Mössbauer isotopes which have transition energies ranging up to the 100 keV regime. Nickel (Mössbauer isotope ^{61}Ni at 67 keV), is, for example, one of the

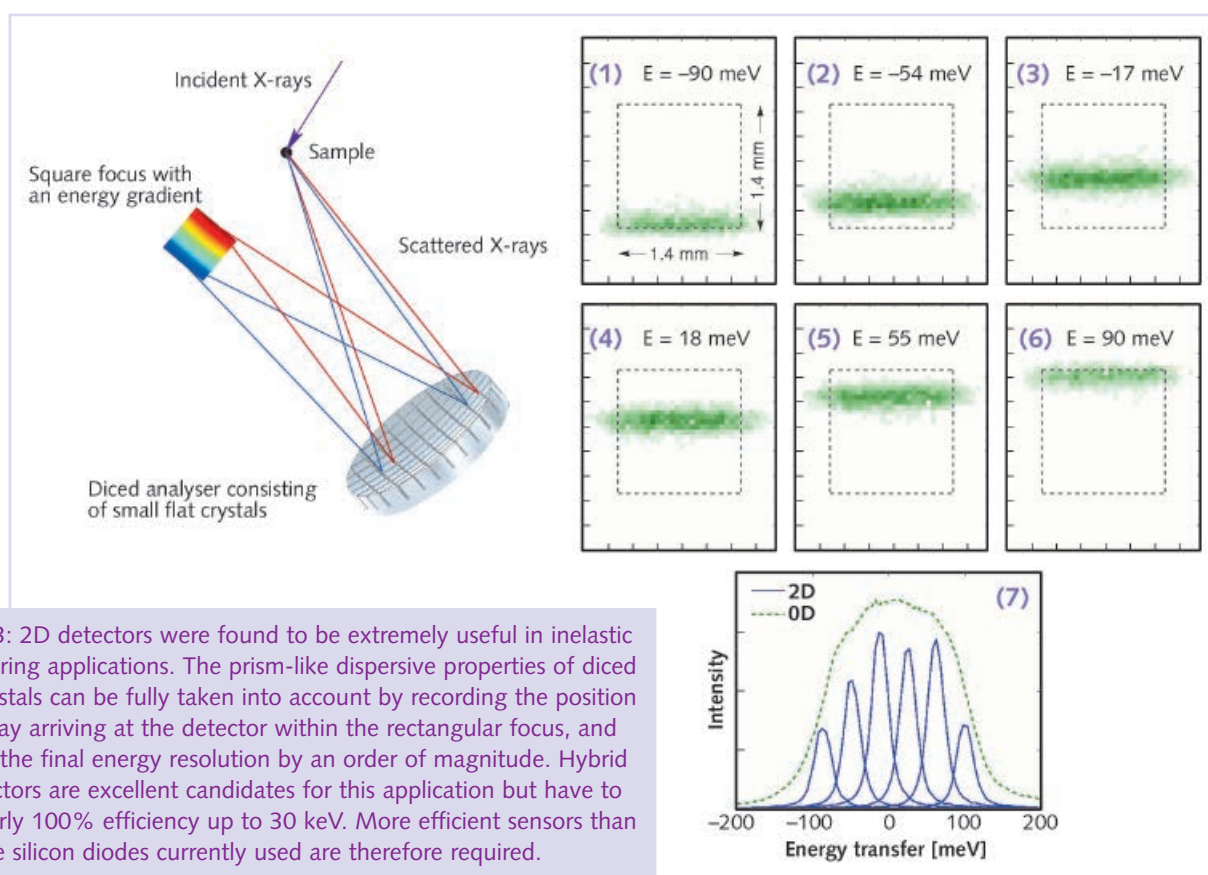

Figure 2.5.3: 2D detectors were found to be extremely useful in inelastic X-ray scattering applications. The prism-like dispersive properties of diced analyser crystals can be fully taken into account by recording the position of the X-ray arriving at the detector within the rectangular focus, and enhancing the final energy resolution by an order of magnitude. Hybrid pixel detectors are excellent candidates for this application but have to provide nearly 100% efficiency up to 30 keV. More efficient sensors than the silicon diodes currently used are therefore required.

most interesting metal elements for functional biology. Some other important isotopes are found in elements such as Nd, Gd, Er, Yb, Np, Sb, Ge with applications to correlated electron systems and for nanoscale materials (see [section 1.4.2](#)). In these applications, single-photon counting detectors with high efficiency are mandatory.

As far as biological material is concerned, the radiation induced sample damage can be mitigated by improving the detector efficiency and also by performing the experiments at higher photon energies. Individual cells and clusters can, for example, be imaged using phase contrast tomography in the hard X-ray regime to reduce absorbed dose (Cloetens *et al.*, 2006) as the optimum signal-to-dose ratio is obtained around 50 keV for low atomic weight elements. This would be an excellent alternative to histology studies of biological tissues that are usually based on a combination of optical or electron microscopy of slices and the results from adjacent sections. Working at high energies is challenging because not only does the efficiency have to be good, in order not to lose what has been gained in reducing dose, but also because a radically improved spatial resolution is required to obtain high quality images.

Sensor technology

Advancing detection efficiency goes hand-in-hand with improving the sensor element that converts the incident X-ray photons into a more easily measurable quantity. In most practical cases, this equates to either electrical charges or visible light. A compromise has to be found between the thickness of the sensor layer and the lateral spatial resolution of the device as far as position-sensitive detectors are concerned. When dealing with X-rays of moderate energy (below 20 keV) and not very high spatial resolution (a few tens of micrometres), it is usually possible to find appropriate materials that provide efficiencies approaching 100%. At higher energies, the situation changes drastically as the sensor absorption drops. Increasing the sensor thickness is not a viable solution: the spatial resolution deteriorates and the collection efficiency (of light or charges) degrades. A similar problem arises with low and medium energy applications aiming for very high spatial resolution at the micrometre or sub-micrometre level. These detectors have to be built around very thin sensors, usually thin film scintillation screens with limited absorption efficiency.

It is therefore not surprising that experiments at high energies or those aiming for high spatial resolution are currently carried out at the ESRF with detectors that provide quantum efficiencies of only a few percent, and, in some extreme cases, that fall well

below 1%. In such conditions, even small absolute improvements in the detector create a substantial increase in the overall efficiency of the experiment.

The sensors foreseen for development within the Upgrade Programme are of two types: high-resolution scintillating screens and semiconductor sensors built on high-Z materials. There is considerable work in progress for applications such as high-energy physics, astronomy, or medical imaging with different materials such as GaAs, CdTe or CdZnTe where semiconductor sensors are concerned. The requirements of scintillators with micrometre and submicrometre spatial resolution are very much specific to synchrotron radiation experiments. The significant improvements achieved in this field over the last 10 years are principally attributable to the leading role played by the ESRF (Martin and Koch, 2006).

Two independent programmes will be launched to develop the areas that have been identified: one on high-resolution scintillators for indirect detection detectors (I3) and another on high-Z semiconductor sensors for hybrid pixel detectors (P6). The development of more efficient sensors is to be coordinated with advances in different areas of material research. This is a field in which progress is slow and difficult. It is therefore not possible to define at this point specific targets for the overall programmes. However, the partial goals of the individual projects that will make up the development programmes will be defined during their preparation phase.

2.5.4. Fast imaging cameras

Developing very fast X-ray cameras with adequate sensitivity increases the current limits of imaging techniques applied to the study of dynamic processes. An example of this can be found in the understanding of dry and wet granular materials. Over the past decade, there has been a growing interest in their fundamental physics as these systems serve as a paradigm for the investigation of fundamental problems of non-equilibrium dynamics (*i.e.* glasses). Theoretical models relating microscopic aspects to macroscopic properties have been tested on 2D systems by means of visible light imaging and microscopy or by only studying the first layers and not the bulk. Ultrafast X-ray microtomography described in [sections 1.3.2](#) and [2.2.2](#) and “flying-path” imaging are unique tools in studying dynamics and phase transitions in granular materials ([Figure 2.5.4](#)) since they can provide direct information on the 3D structure of the granulate during shear, agitation, etc. with millisecond time resolution (Herminghaus, 2005).

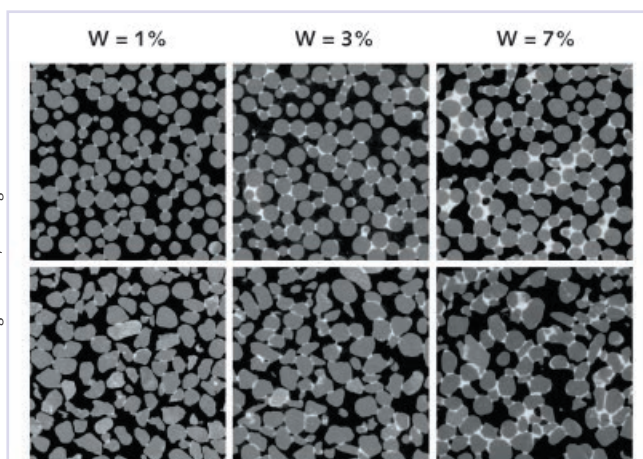

Figure 2.5.4: Tomographic sections of glass beads (upper panel) and sand (lower panel) as a function of the liquid content. Mechanical properties are determined by a random network of capillary bridges formed between adjacent grains, exerting attractive forces upon them by virtue of the surface tension of the liquid. This effect governs the static and dynamic properties of hill slopes (landslides), the physics of mixing and agglomeration in food processing and pharmaceutical preparation. Up until now, X-ray tomography has been performed on static or slowly evolving granular systems. Shorter data collection times allowed by faster detectors will make it possible to access the dynamics in the millisecond timescale.

The study of phase transitions and kinetics in colloidal systems is another interesting area that will benefit from faster imaging. This subject has been widely studied in real space over the last few years using confocal microscopy (Aarts *et al.*, 2004). The limited time resolution of this technique has restricted its use to two-dimensional imaging of sections of the sample. High-speed high-resolution phase contrast imaging is a promising technique for studying crystal-glass transitions induced by temperature change, shear forces, etc., in three dimensions and with a very high temporal resolution.

Fast high-energy imaging detectors will also enable functional physiological 3D imaging studies of small animals using contrast agents such as iodine, xenon and gadolinium. The whole volume of the organ will be imaged in 0.1 to 1.0 seconds with a spatial resolution of the order of 10 μm (see [section 1.5.2](#)).

Detector technology

Most of the imaging applications make use of indirect detection schemes whereby a phosphor screen converts the X-ray image into a visible pattern that is recorded by a CCD sensor. The use of integrating detectors is mandatory as the photon flux is usually quite high. This configuration allows detectors to be built with small pixels, which is usually required by

this kind of application. In practice, the spatial resolution is limited by the phosphor and the effective pixel size can be adjusted over a rather wide range by using the appropriate optical coupling. The use of directly illuminated CCDs or pixel detectors is, in general, not appropriate due to their reduced tolerance to irradiation (Renzi *et al.*, 2002) and the lack of flexibility in the choice of pixel size.

The fastest 2D X-ray cameras used on our beamlines allow dynamic changes in the few millisecond range to be imaged. Full tomographic data sets consisting of a few hundred images can be collected in slightly less than 1 second. Recent fast cameras and components developed for other scientific and military imaging applications will be very useful in building X-ray detectors that go beyond those limits. Specific developments will be required in order to produce detectors with the highest performance.

Despite the fact that CCDs remain the reference sensors for scientific imaging, CMOS active pixel sensors are potentially interesting candidates for very fast imaging detectors. This is as a result of the particular features that this technology offers, like an electronic shutter or selected readout of regions of interest at higher speeds. The use of adequate phosphor screens with a short response time and correct matching with the optical sensor is also important.

The programme on fast cameras (I2) aims to produce detectors able to record long series of 2D images at several thousands of frames per second with sufficient sensitivity to be used in imaging applications at the ESRF. The typical image size in these applications is 1000 x 1000 pixels with a minimum dynamic range of 10 bits. The required sensitivity is very much determined by the specific applications as it strongly depends on the intensity collected by the detector, as well as on the characteristics of the phosphor and optics that are linked to the spatial resolution.

2.5.5. Time-resolved hybrid pixel counting detectors

Detectors currently offer the choice of either very high temporal resolution (*e.g.* APDs) or a large detection area with high spatial resolution (*e.g.* CCDs). Hybrid pixel detectors have begun to simultaneously offer both of these features. A 2D detector with nano- or microsecond resolution would result from an extrapolation of the technology. Immediate gain could be obtained in pump-and-probe experiments by extending the current accessible time domain towards shorter times and higher frame rates. This will replace the very inefficient stroboscopic

method (see chapter 2.3) and make many new and exciting scientific opportunities possible. Examples include molecular and reaction dynamics investigated by diffraction experiments such as those described in section 1.3.3. A nanosecond-resolving detector, which could follow the entire cycle after one laser pump flash and many (probe) X-ray flashes would be the most exciting feature of this new technology. The entire reaction would then be “filmed” in real-time.

Another very interesting case to be studied is magnetisation dynamics. This has again become a challenge due to emerging new phenomena in low dimensional systems. X-ray techniques such as XMCD, magnetic scattering, and NRS make it possible to study those magnetic properties and their dynamics with unprecedented sensitivity (see also section 1.4.2). A scanning experiment with a 0D detector with nanosecond resolution has shown how nuclear small angle scattering can provide information on the coarsening of antiferromagnetic domains driven by a spin-flip transition induced by small external magnetic fields. A 2D detector would catch the entire momentum space whilst being able to resolve magnetisation dynamics down to the nanosecond scale (Figure 2.5.5). This will allow pump-and-probe experiments with sub-nanosecond magnetic pulses to be carried out. The hard X-ray regime not only makes surface phenomena accessible but also buried objects, *i.e.* bulk sensitivity is available. The gain in efficiency with a fast 2D detector for bulk experiments would mean that the time needed for data collection would be significantly reduced for those experiments that currently take many days to complete.

The time window for rapid kinetics in soft condensed matter and biological systems is typically in the range of the micro- and submicrosecond. However, in many cases, the complex free energy landscape of these systems restricts the precise synchronisation of kinetic events and prevents the application of stroboscopic techniques. Therefore, real-time measurements are essential in addition to stroboscopic methods for unravelling fast processes in these complex systems. Examples that can be studied by small and wide-angle X-ray scattering include early stages of protein folding, amphiphilic self-assembly, orientational switching in liquid crystals, rapid nucleation and growth kinetics and polymer processing under industrial conditions (*e.g.* see sections 1.2.3, 1.2.4, 1.4.2). These experiments will require a high efficiency photon counting 2D detector with submicrosecond time resolution.

The same is true in the case of probing fast equilibrium dynamics using XPCS with two-dimensional detectors. Examples include magneto-hydrodynamics in ferrofluids, many-body interactions in charge stabilised suspensions, microrheology by

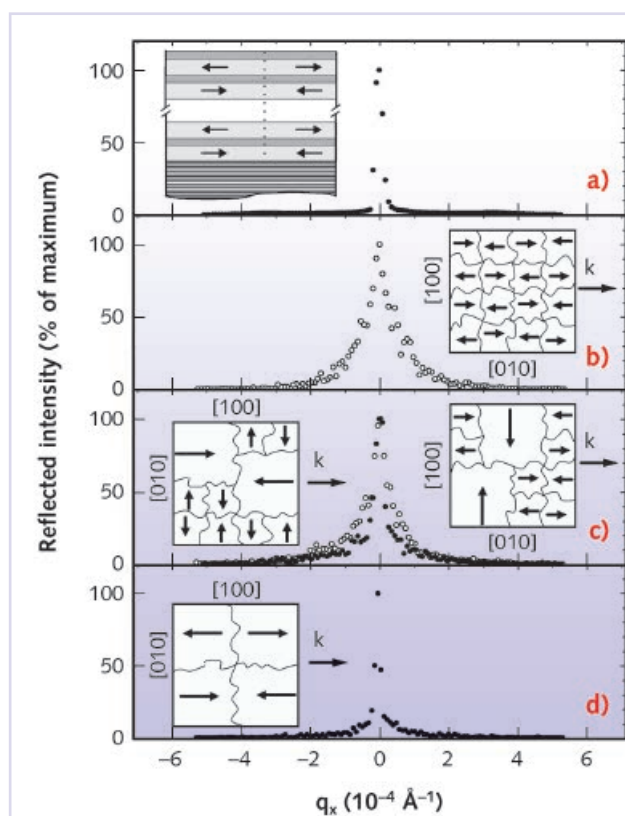

Figure 2.5.5: NRS off-specular ω -scans with fast 0D APD detector. Reflected intensity vs. scattering vector component q_x of a MgO (001)/[$^{57}\text{Fe}(26 \text{ \AA})/\text{Cr}(13 \text{ \AA})$] $_{20}$ multilayer at the antiferromagnetic Bragg-reflection. The crystallographic (A) and magnetic (B-D) structures (domains) have been deduced during a magnetically imposed spin-flip transition (Nagy *et al.*, 2002). A 2D detector with nanosecond resolution would permit the entire momentum space to be probed simultaneously.

Reprinted figure with permission from D.L. Nagy, L. Botthán, B. Croonenborghs, L. Deák, B. Degroote, J. Dekoster, H.J. Lauter, V. Lauter-Pasyuk, O. Leupold, M. Major, J. Meerschaut, O. Nikonov, A. Petrenko, R. Ruffer, H. Spiering, and E. Szilágyi, Coarsening of Antiferromagnetic Domains in Multilayers: The Key Role of Magnetocrystalline Anisotropy, Phys. Rev. Lett. 88, 157202 (2002). Copyright 2002 by the American Physical Society. <http://link.aps.org/abstract/PRL/v88/e157202>

nanoparticle tracer diffusion and surface diffusion and viscoelasticity of soft-matter thin films. In the case of XPCS with strongly scattering samples, the availability of detector systems with nanosecond time resolution would push the present limit down by nearly six orders of magnitude.

Other fields that will benefit from time-resolved detection are studies with high pulsed magnetic fields that can currently reach values of 30 to 50 T (Frings *et al.*, 2006). The typical pulse duration is about 5 ms in large installations or in the sub-millisecond regime when using mini-coils. Fundamental science gives rise to challenging topics such as quantum correlation effects in condensed matter (see section 1.4.2) and further applications such as exothermic solid state chemical reactions and online topography of the formation of metal foams. A fast area detector with microsecond resolution would allow the scattered intensity to be monitored as a function of the field value. In a feasibility experiment with a 25 T mini-coil with 0.5 ms pulse width, time-resolved nuclear

forward scattering spectra have been collected over the entire pulse width with a fast APD detector ($\Delta t \approx 0.8$ ns). A time-resolved 2D detector will make the entire diffraction spectrum accessible, allowing structural, electrical, or magnetic changes to be studied in real time.

Detector technology

Most ongoing development projects on 2D hybrid pixel detectors for X-ray detection process the incident radiation impinging at each pixel on a photon-by-photon basis (see [section 2.5.2](#)). The detector includes an electronic shutter and every pixel integrates a digital counter that is incremented each time a photon hits that pixel. In the case of time-resolved applications, it is possible to accumulate data in microsecond timeframes by properly controlling the shutter signal. The time resolution is ultimately limited by the time required to process every individual photon, *i.e.* at least a few hundreds of nanoseconds. This is an indirect consequence of the use of sensors based on PIN silicon diode structures.

In a pump-and-probe experiment, only one frame can be acquired during a full repetition cycle with the current architectures and readout schemes. This very low duty cycle results in extremely inefficient experiments, especially if the ultimate microsecond time resolution is pursued. The limitations of the existing designs, both in terms of efficiency and time resolution, could be solved by using new detectors specifically developed for applications that target resolution in the sub-millisecond range.

The efficiency of the experiment could be drastically improved by implementing readout schemes that allow as many frames as possible to be accumulated during the same data acquisition cycle. The multiple frame accumulation could be implemented either in the pixel, by integrating a large number of counters, or in external histogramming units if the information on every single photon event is tagged and transmitted to the back-end electronics. The limit in time resolution can be pushed to the nanosecond range by using sensors more sensitive than PIN diodes, like avalanche photodiodes (APD). The enhanced sensitivity due to the avalanche multiplication process makes it possible to use higher speed electronics and therefore reach nanosecond time resolutions. Moreover, for the same reasons, pixel detectors built with avalanche photodiodes would accept photon counting rates two orders of magnitude higher.

Two programmes are foreseen aiming to develop detectors with time resolution capabilities, these are described in [section 2.5.8](#). The first programme (P3) will be a direct evolution of current counting pixel

detectors but with an improved data readout architecture to fully exploit their intrinsic microsecond time resolution.

For multi-frame storage, the detector would produce as many frames per acquisition cycle as counters or registers implemented in the pixel, ideally more than 100. In the case of event-by-event readout, an ambitious goal is to process up to 10^{10} photons per second.

The second programme (P4) will develop hybrid pixel detectors using APD arrays as sensor layers. These detectors will provide time resolution close to or below 1 nanosecond but their development will be much more challenging. They will require very fast readout electronics and a significant effort in research and development in order to produce large area APD sensors. Both readout architectures will be studied in this case.

2.5.6. Pixel detectors with extended dynamic range

SAXS experiments have very demanding requirements for dynamic range. The scattered intensity can vary up to four orders of magnitude for each decade in scattering vector (Porod law). Combined SAXS and USAXS cover more than three orders of magnitude in scattering wave vector. A typical example requiring detectors with very high spatial resolution and dynamic range is the line shape analysis of Bragg peaks from quasi-ordered soft matter (*e.g.* lipid membranes). In this case, Bragg peaks follow power-law decay that can be used to investigate undulation properties of membranes and derive the corresponding elastic moduli. In electrostatically stabilised lipid membranes and block copolymer lamellar phases, the Bragg peaks are extremely sharp, which limit the line-shape analysis by the detector resolution and dynamic range. Moreover, these samples are sensitive to radiation, and so high-resolution scanning analysers are not suitable for these studies. More complex systems involving these lipid membranes with encapsulated guest biomolecules (*e.g.* systems used in bio- and nanotechnologies) would have additional peaks appearing, due to the ordering of these intercalated molecules, as weak features next to the strong Bragg peak of the membrane. Resolving these faint peaks is critical in understanding these self-assembled structures. A similar detector requirement also arises in line shape analysis of Bragg peaks of photonic crystals. In this case, the underlying questions involve long-range periodic order, crystalline disorder, etc.

Another example can be found in the study of small structural distortions in systems such as piezoelectric

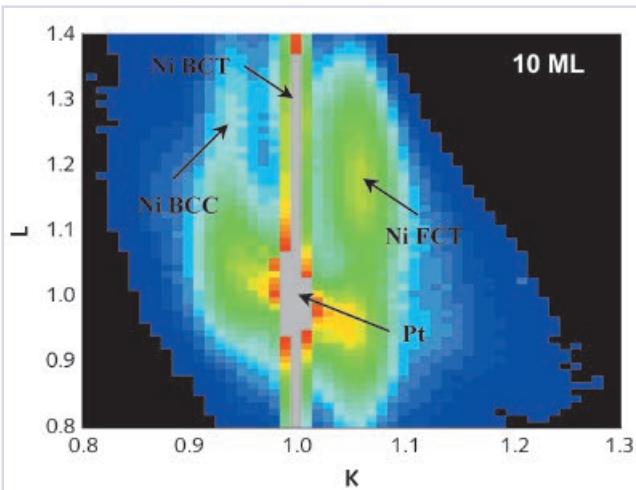

Figure 2.5.6: Reciprocal space map of diffracted intensity from ten monolayers of Ni on a Pt (001) substrate illuminated by grazing incidence X-rays. The integrated intensity of the Pt (011) peak is about 10^{11} photons per second while the crystal truncation rod along the $K=1$ direction is only a few orders of magnitude weaker. Both features are shown in grey in the figure, as they are above the maximum of the logarithmic colour scale. The data were obtained by scanning a 0D counting detector. The scan lasted about two hours and required variable beam attenuation to avoid the saturation of the detector. The full data could be recorded in seconds with a 2D detector covering ten decades of intensity variation.

and ferroelectric materials. These distortions are the key to understanding and controlling the properties of that wide range of materials. They often arise during a phase transition upon cooling from higher temperature and are associated with a change in physical properties. Despite the intense interest, the precise arrangement of these small distortions in many technologically important materials remains a matter of debate. Structurally determining these materials with sufficient accuracy would allow competing theoretical models to be distinguished in a number of systems. A key challenge when studying these small distortions is that the information is contained in superstructure peaks, whose diffracted intensities are very weak in comparison to those from the average structure. New two-dimensional detectors, able to record the whole diffraction pattern with sufficient accuracy, should provide a dynamic range that goes beyond what is currently achievable.

Using good single crystals, grazing X-ray diffraction experiments have to cope with diffracted intensities that range from a few real counts up to 10^{12} photons/s at the Bragg peaks. This is illustrated in Figure 2.5.6, which shows a diffracted intensity map from 10 monolayers of nickel deposited on top of a Pt (001) substrate. Much weaker features coming from different structures of the Ni coating can also be distinguished and are identified by arrows in the

figure. The use of filters was required to attenuate the strongest peaks. It took about two hours to record the full data set, but it has been demonstrated how the measurement time can be drastically reduced by using two-dimensional detectors (Schlepuetz *et al.*, 2005). Detectors with extended dynamic range will allow complete measurements to be performed with the full incident beam and the reciprocal space to be explored by continuous motion scans in shorter times. This will make it possible to study dynamic processes at timescales not currently accessible.

Detector technology

As shown in section 2.5.2, progress of hybrid pixel technology has helped to develop two-dimensional photon counting detectors particularly suitable for scattering experiments. These detectors combine many of the useful features of gas filled detectors and CCD cameras. In parallel, they overcome some of their limitations. The dynamic range of hybrid pixel counting detectors is very large because they provide single photon sensitivity and can be operated with nearly zero noise. However, the effective maximum counting rate per pixel is limited to about 10^6 photons per second, which is not sufficient in experiments with strongly scattering samples. It would be possible to overcome such limitations with detectors able to operate in integration mode in which the sensitivity could be adjusted pixel by pixel. Several schemes can be considered including implementing variable gain, variable integration time or using “counting-

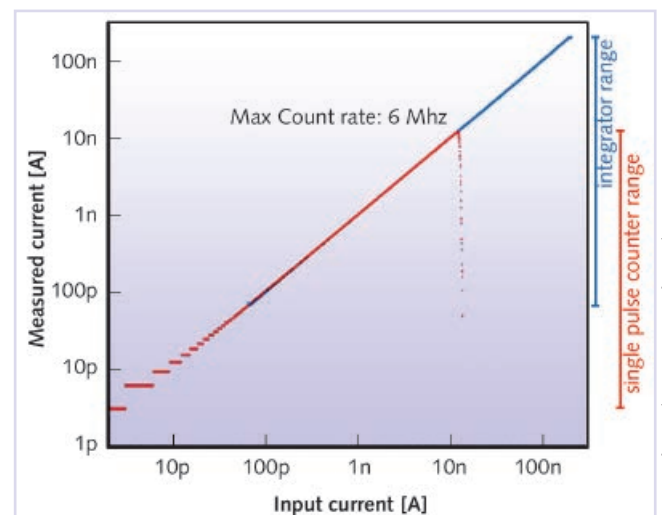

Figure 2.5.7: Test results of the CIX readout chip for X-ray pixel detectors (Kraft *et al.*, 2007). Every pixel is designed to operate simultaneously in photon counting (red) and charge integration (blue) modes. The figure shows the pixel response when the input signal is simulated by 2 fC pulses. In case of random photon arrival, the integration mode would extend the usable dynamic range of the detector by about two orders of magnitude with respect to the simple counting mode.

courtesy of P. Fischer, University of Mannheim.

integration" mixed modes (Figure 2.5.7). This type of detector will provide an unprecedented dynamic range that will allow the high brilliance of the synchrotron radiation beams to be exploited.

The programme P5 aims to develop 2D detectors that will provide an exceptional overall dynamic range by setting independent sensitivity values for each pixel. Ideally those detectors should be able to detect individual photons in part of the detection area at the same time as measuring very strong diffracted beams (of up to $\sim 10^{12}$ photons/s over a few pixels) in other regions. It is not expected that such highly advanced technology will be achievable during this programme; substantial progress in this area will, nonetheless, be extremely useful.

2.5.7. Energy dispersive 2D detectors

Two-dimensional detectors with energy resolution of a few tens of electronvolts will have a tremendous impact on how experiments are implemented in the future. They will enable, for instance, high-resolution spectroscopy at high energies without a scanning analyser. Three-dimensional electron momentum distribution studies will be done in a fraction of an hour instead of days(s) with three times better resolution. The increase in the resolution for magnetic momentum density studies would be enormous: a factor of twenty. This gain in resolution will mean that Fermi features can be studied and spin polarisation of the bands can be determined, yielding new research possibilities, for example, on spintronics materials.

The energy discrimination with high dynamic range will also enable complex structures such as quasicrystals and super lattice structures to be studied. The coherent signal of interest is buried in the inelastic background, which can be enormous, as shown in the hydrogen example in the introduction to this chapter. The energy resolution has to be very good in order to remove this inelastic contribution since the Compton shift is rather small under the desired momentum transfer regime (see Figure 2.5.8). Compton scattering is also a real problem in the studies of crystallographically challenged materials, liquids, glasses and nanoparticles. For example, in experiments on laser excited liquids (see section 1.4.3), the signal disappears in a large background around 8 \AA^{-1} . If this background could be discriminated, the signal-to-noise ratio would be improved by a factor of 2.7 in methanol and coherent signal could be detected further in reciprocal space. This would yield better resolution in real space and higher discriminating power. This gain can be illustrated by the fact that eight times longer undulators would be needed to obtain an equivalent improvement.

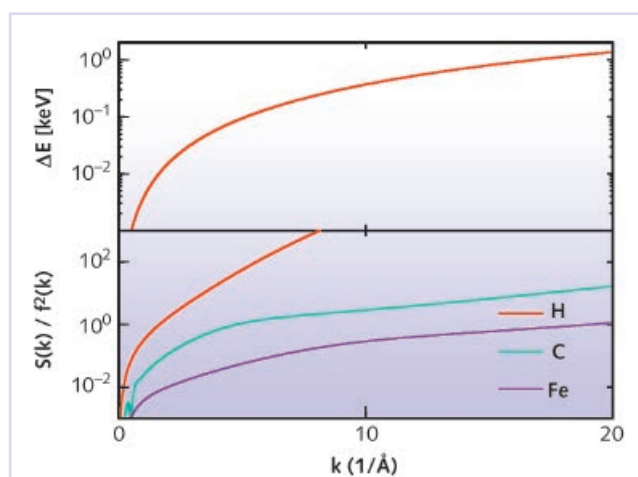

Figure 2.5.8: The Compton shift (upper panel) is very small at low momentum transfer which sets high requirements for the energy resolution of the detector. The inelastic/elastic scattering ratio (lower panel) shows how important it is to cut the background especially in the case of low atomic weight materials. Suppressing the Compton background is challenging as it requires energy discrimination well below 100 eV.

Most novel macromolecular structures are currently solved nowadays by the use of single- or multiple-wavelength anomalous scattering (SAD/MAD). These techniques rely on the measurement of small intensity differences between Bijvoet related reflections, which can be attributed to a subset of artificially introduced atoms within the macromolecule. The increased fluorescence and resonant Raman background together with Compton background compromises the measurement of small intensity differences. This often cannot be compensated for by increased exposure, as biological samples have a very limited lifetime in the beam. Energy dispersive detectors could have a great impact in macromolecular crystallography by eliminating the contributions of X-ray fluorescence and Compton scattering from the collected signal.

Detector technology

An energy dispersive 2D detector for spectroscopic applications with synchrotron radiation should combine an array of sensor elements with a fully parallel readout. Energy resolution should be below 1% while every readout channel accepts count rates close to 10^6 photons/s. Recent developments of monolithic sensors designed for spectroscopy applications like pnCCD or DEPFET arrays, have allowed X-ray detectors to be constructed that come close to the intrinsic limiting energy resolution of silicon (Velthuis *et al.*, 2006). Progress has been made in the maximum count rates and those detectors could prove very interesting for synchrotron radiation applications.

Cryogenic detectors are another family of technologies that has the capability to push the energy resolution down to several tens of electronvolts. Intensive work is ongoing to reduce the response time of those detectors and make them able to operate at high photon count rates (Fiedrich, 2006). The possibility of making 2D arrays with a large number of pixels is challenging and needs substantial research work but should not be overlooked by the synchrotron radiation detector community.

The detector programme E1 will evaluate the potential of emerging technologies such as tunnel junctions, microcalorimeters or DEPFET arrays to produce usable energy dispersive 2D detectors for synchrotron radiation experiments. The programme may envisage developing prototypes not only for evaluation but for routine use on beamlines.

2.5.8. Specific detector programmes

The main goal of the ESRF concerning detectors is to produce advanced X-ray detectors that can be used routinely on the beamlines within the next 10 years. However, some of the programmes have a longer term vision that goes beyond the 10-year period and development should continue once this has finished. The development programmes that focus on two-dimensional detectors have been organised into three groups: indirect detection (I1–I3), hybrid pixel detectors (P1–P6) and energy dispersive detectors (E1). They are described in the following paragraphs:

I1: High-sensitivity CCD detectors. Development of large area X-ray detectors by integrating new high performance commercially available sensors with fast and very sensitive electronics. The goal is to develop CCD detectors that combine high dynamic range and single photon sensitivity with spatial resolutions of the order of 50 μm and readout speeds of several frames per second. The progress of the CCD industry and existing experience and know-how, and in particular at the ESRF with the FReLoN programme, will be essential in producing usable detectors with much improved characteristics in the medium term. The possibility of developing custom CCD sensors for synchrotron applications will also be considered.

I2: Very fast imaging cameras. The purpose of this programme is to develop very fast high-resolution X-ray cameras with sub-millisecond framing capabilities. The initial steps in this programme will be oriented towards evaluating recent developments for fast imaging in other scientific domains and building X-ray cameras based on the most promising devices. The possibility of designing specific sensors to achieve ultimate performance will only be considered at a later stage. An ambitious goal foreseen

is to build detectors that can produce images at 10 kHz with at least 1000 x 1000 pixels and 12 bits of dynamic range. CMOS active pixel sensors seem to be the most attractive technology for this kind of detectors. These projects should be matched to the development of phosphors with adequate time response and efficiency (see I3).

I3: High-resolution scintillators. Current efforts will continue in producing scintillator screens with improved characteristics in terms of overall light conversion efficiency and spatial resolution. This activity, successfully developed over the last few years, will be reinforced within the framework of the Upgrade Programme. The efforts will not be limited to the production of new materials of good optical quality; new technologies and methods that may provide improvements will also be explored. Different kinds of structured screens to improve the spatial resolution or the use of photonic crystals to increase the light extraction from the luminescent layer are amongst the options that will be considered.

P1: Diversification of hybrid pixel detector technology. The projects in this programme will improve aspects such as interconnection, tiling or readout speed. They will also be used to develop technologies and methods that will be used for implementing detectors like those proposed in programmes P2 to P5. In addition to technical enhancements, like increased radiation hardness and the reduction in pixel size and dead detection areas, the programme aims to diversify hybrid pixel technology. Detector diversification will be necessary to allow pixel detectors to play a central role in future experiments. This programme should be coordinated with ongoing projects like the new detectors for the European XFEL or the evolution of current counting pixel detectors such as PILATUS or XPAD.

P2: Small pixel hybrid detectors. This programme will ensure the design and production of radiation hard photon counting pixel detector modules with a pixel size of about 50 micrometres or less and that will be tiled to cover arbitrarily large detection areas with minimum dead zones. The key characteristics of this detector will not be fundamentally different from the specifications already implemented in existing pixel detectors, but the goal of this programme is to combine all of those features into the same device.

P3: Pixel detectors with microsecond time resolution. This programme will develop pixel counting detectors analogous to current devices but with a readout architecture optimised for time-resolved applications with less than 1 microsecond resolution. The full specification of the detector or detectors and the choice of readout architecture, either multiframe storage or even by event readout, will be carried out during the initial phases of the project.

P4: APD-based pixelated detectors. Development of hybrid pixel detectors using APD sensors instead of PIN diodes. These detectors will provide nanosecond time resolution and an increased dynamic range. The programme will require very fast mixed analogue–digital microelectronics and developments in sensor technology. Initially, APD sensors will be limited to sizes of about 1 cm², and the construction of larger detector modules will require adequate sensors to be produced.

P5: Pixel detectors with extended dynamic range. Development of pixel detectors that extend the achievable dynamic range towards higher photon fluxes. The new devices need to be able to operate in integration mode and select the sensitivity pixel-by-pixel depending on the incident flux on the detector. The purpose of the programme is to explore novel ideas and develop detectors with the maximum achievable dynamic range whilst retaining single photon sensitivity at low fluxes. Previous experience in pixel detectors with integration or mixed counting-integrated modes will be invaluable.

P6: High-Z semiconductor sensors. The programme will be added to the other ongoing projects, driven mostly by other applications, that hope to improve semiconductor sensors using good efficiency at high energies. The resources provided within the framework of the Upgrade Programme will allow research to be undertaken in collaboration with material research laboratories and manufacturers. This will allow the most appropriate materials to be selected, their properties to be improved, full sensors to be produced and their performance to be evaluated with existing pixel detector readout chips.

E1: Energy-dispersive 2D detectors. This programme will evaluate and promote the emerging technologies that can provide X-ray detection with energy resolution below a few hundred electronvolts. The initial studies will analyse the application requirements in detail and identify the possibilities and expected limits of the technology put forward, as well as the specifications of feasible prototypes. The ultimate goal will not only be to evaluate prototypes, but to develop detectors to be used in real applications that will take advantage of the energy resolution capabilities, even if this compromises other detector specifications.

Implementation of the detector programmes

The detector programmes listed above will form the basis of the ESRF proposal to establish common long-term detector initiatives with other synchrotron radiation sources and their associated laboratories. New requirements of other facilities should be considered in joint detector developments. A first

priority is to agree on common objectives, the selection of the final projects and the specifications of the future detectors. In order to achieve this, workshops will be organised on each of the main technical areas envisaged: indirect detection, hybrid pixel technology and energy dispersive 2D detectors. The purpose of the workshops will be carefully defined in advance so that the participants are in a position to undertake the following:

- Give an overview of the state-of-the-art in the corresponding field
- Present and discuss the objectives and proposals of the ESRF
- Explore the degree of interest of other European facilities in joining this initiative
- Create contact networks between the synchrotron radiation facilities and detector development laboratories and manufacturers.

The workshops will be followed by a number of additional meetings so that working groups can be organised on well defined additional topics. These working groups will be able to better define the projects and the action plans required to start development of the projects. The actual number of these and the extent to which they will be developed will very much depend on the resources available. The time needed to put the action plans into place will depend on how advanced the technology involved is.

Many important issues need to be addressed as far as the proposed developments are concerned. It is important, for example, that compatibility is apparent between the proposed developments and the current ongoing projects in Europe. It is also extremely important that production and support structures are prepared that will guarantee that the detectors are available once the developments are finished.

The central detector development programme at the ESRF will be financed within the framework of the Upgrade Programme. The ESRF intends to create a group focused on the microelectronics development necessary to lead to enhanced performance of the new lines of detectors. This group will be responsible for ensuring that the developments are undertaken correctly. They will also establish the necessary contacts, partnerships and outsourcing with industry to prototype and manufacture the new detectors.

Standardisation of components and detector integration

An extensive development programme cannot be implemented without first defining the standard components. Standardisation will include the elements or technology required for constructing the detectors, as in programme P1, as well as data

acquisition interfaces and hardware and software building blocks. The standard blocks will be technically suitable to be reused by the majority of the projects. This will help to reduce the resources and development time required. In a large facility like the ESRF, integrating new detectors on the beamlines consumes a huge amount of resources, both manpower and beam time. Using standard hardware and software interfaces will therefore make this easier.

Defining standard data acquisition architectures becomes necessary if the high data rates expected to be produced by the new detectors are taken into account. This is a significant undertaking and is also being considered within the detector programmes of fourth-generation sources like the European XFEL. Collaboration in this area between facilities will be extremely helpful and therefore strongly backed.

Special detectors

The development programmes proposed above will not cover all of the requirements of the many different experimental stations at the ESRF. Some of these requirements will be fulfilled using specific solutions based on commercial detectors. These are to be into practice at the ESRF or on shorter term developments that will be implemented at the ESRF or outsourced, depending on the nature of the problem to be solved. The latter option will be preferable if the detector can be designed and built on the basis of well established technology. It is planned to use outsourcing when dealing with spectroscopy detectors, custom optics or standard CCD integration.

Detector integration

Development is not the only activity to be considered when improving strategy on detectors. Integrating new detectors on the beamlines is also fundamental. In-house know-how and expertise are of great importance. The effectiveness of the current ESRF detector support structure and its contribution to the success of the facility rely very much on its capacity to customise the detectors to individual applications and to provide efficient support to the beamlines. This needs to be maintained in the future, where a very important part of the new developments will be implemented at other laboratories.

Detector software challenges

Faster and larger 2D detectors mean that the optimal use of the resources of the computer supporting the detector is critical for the optimal performance of the detector itself. Traditionally, the readout time of the

detector has been the main limiting factor for the acquisition speed. However, the data link, acquisition board, hard disc writing speed or alternatively, the size of the available memory are all currently parameters to be considered when ensuring the maximum performance of the detector.

Evolving technology can only relieve the demand that the new detectors will impose on computers up to a certain point. The challenge for the detector software will then be to administer resources optimally in order to obtain maximum detector performance in each operation mode.

The proposal for the low-level detector software development can be divided into two parts:

- a. **Dedicated detector drivers** will be developed with intimate knowledge of both the detector functionalities and basic computer possibilities.
- b. **A generic library** in charge of allocating and handling computer resources in the most efficient manner: this library should provide different operation modes for the detector (continuous acquisition, memory-only acquisition with large buffer allocation, etc.). It should take into account the functionalities offered by each detector. This library will offer a common Application Programming Interface (API) for higher level data acquisition software.

It is advisable to propose the development of this library as a joint project with other European facilities in order to promote a standard for the detector application program interface. Potential compatibility with emerging industry software standards should also be considered. This detector development will have a strong influence in other computer related areas such as online data visualisation and analysis, handling and storage of data and scientific computing: all of these aspects are covered in detail in [chapter 3.3](#).

References

- Aarts D.G.A.L., Schmidt M., and Lekkerkerker H.N.W. (2004), Direct visual observation of thermal capillary waves, *Science*, **304**, 847-850.
- Broennimann C., Eikenberry E.F., Henrich B., Horisberger R., Huelsen G., Pohl E., Schmitt B., Schulze-Briese C., Suzuki M., Tomizaki T., Toyokawa H., and Wagner A. (2006), The PILATUS 1M detector, *J. Synch. Rad.*, **13**, 120-130.
- Cloetens P., Mache R., Schlenker M., and Lerbs-Mache S. (2006), Quantitative phase tomography of Arabidopsis seeds reveals intercellular void network, *Proc. Natl. Acad. Sci. USA*, **103**, 14626-14630.
- Coulibaly F., Chiu E., Ikeda K., Gutmann S., Haebel P.W., Schulze-Briese C., Mori H., and Metcalf P. (2007), The molecular organization of cyovirus polyhedra, *Nature*, **446**, 97-101.
- Fiedrich S. (2006), Cryogenic X-ray detectors for

- synchrotron science, *J. Synch. Rad.*, **13**, 159-171.
- Frings P., Vanacken J., Detlefs C., Duc F., Lorenzo J.E., Nardone M., Billette J., Zitouni A., Bras W., and Rikken G.L.J.A. (2006), Synchrotron X-ray powder diffraction studies in pulsed magnetic fields, *Rev. Sci. Instrum.*, **77**, 063903.
 - Herminghaus S. (2005), Dynamics of wet granular matter, *Adv. Phys.*, **54**, 221-261.
 - Huotari S., Vankò G., Albergamo F., Ponchut C., Graafsma H., Henriquet C., Verbeni R., and Monaco G. (2005), Improving the performance of high-resolution X-ray spectrometers with position-sensitive pixel detectors, *J. Synchrotron Radiat.*, **12**, 467-472.
 - Kraft E., Fischer P., Karagounis M., Koch M., Kruger H., Peric I., Wermes N., Herrmann C., Nascetti A., Overdick M., and Rutten W. (2007), Counting and integrating readout for direct conversion X-ray imaging concept, realization and first prototype measurements, *IEEE Trans. Nucl. Sci.*, **54**, 383-390.
 - Linari M., Piazzesi G., Dobbie I., Koubassova N., Reconditi M., Narayanan T., Diat O., Irving M., and Lombardi V. (2000), Interference fine structure and sarcomere length dependence of the axial X-ray pattern from active single muscle fibres, *Proc. Natl. Acad. Sci. USA*, **97**, 7226-7231.
 - Martin Th., and Koch A. (2006), Recent developments in X-ray imaging with micrometer spatial resolution, *J. Synch. Rad.*, **13**, 180-194.
 - Nagy D.L., Bottyán L., Croonenborghs B., Deák L., Degroote B., Dekoster J., Lauter H.J., Lauter-Pasyuk V., Leupold O., Major M., Meersschant J., Nikonov O., Petrenko A., Rüffer R., Spiering H., and Szilágyi E. (2002), Coarsening of antiferromagnetic domains in multilayers: the key role of magnetocrystalline anisotropy, *Phys. Rev. Lett.*, **88**, 157202.
 - Phillips W.C., Stewart A., Stanton M., Naday I., and Ingersoll C. (2002), High-sensitivity CCD-based X-ray detector, *J. Synch. Rad.*, **9**, 36-43.
 - Renzi M.J., Tate M.W., Ercan A., Gruner S.M., Fontes E., Powell C.F., MacPhee A.G., Narayanan S., Wang J., Yue Y., and Cuenca R. (2002), Pixel array detectors for time resolved radiography, *Rev. Sci. Instrum.*, **73**, 1621-1624.
 - Schlepuetz C.M., Herger R., Willmott P.R., Patterson B.D., Bunk O., Broennimann C., Henrich B., Huelsen G., and Eikenberry E.F. (2005), Improved data acquisition in grazing-incidence X-ray scattering experiments using a pixel detector, *Acta Crystallogr.*, **A 61**, 418-425.
 - Velthuis J.J., Kohrs R., Reuen L., Treis J., Zhang C., Andricek L., Fischer P., Giesen F., Krüger H., Lutz G., Mathes M., Moser H.G., Peric I., Richter R.H., Sandow C., Strüder L., von Törne E., Trimpl M., and Wermes N. (2006), Status of DEPFET, *Nucl. Instrum. Methods*, **A 569**, 57-60.



The European Light Source

ESRF SCIENCE AND TECHNOLOGY PROGRAMME 2008-2017

PART 3

Infrastructure to Enable New Science

Overview to PART 3

Infrastructure to Enable New Science

The future scientific and technological needs of the ESRF for the period 2008 to 2017 require a coherent expansion and adaptation of its current infrastructure. A long-term vision for the building, X-ray source, and computing development programmes is a prerequisite before any implementation. Infrastructures, especially for an existing and operational facility, are difficult and expensive to modify with large modifications interrupting operation of the ESRF with extended shutdowns. Part 3 describes the infrastructure programmes required to implement the science and technology described in Parts 1 and 2.

Increasing the brilliance of the X-ray beam and preserving the highly reliable operation are the foundations of the two-fold strategy of the accelerator and source complex upgrade ([chapter 3.1](#)). Firstly, the scientific requirements will be better met by increasing the length of selected straight sections for even more flexibility, increasing the storage ring current, and by achieving better stability of the thermal load on beamline optics by implementing a top-up operation in some filling modes. Secondly, the programme will upgrade and replace obsolete components and systems. These include replacing the current Klystron-based radio frequency transmitters by modern transistor-based devices and migrating to higher order mode (HOM)-free radio frequency cavities.

The building programme ([chapter 3.2](#)) will create new space to accommodate the requirements outlined in the scientific plans of Part 1 and 2. Extensions to the current ESRF experimental hall are the most effective way of making nanometre sized beam spots available on a larger number of experimental stations. Nanometre-sized focal

spots can only be effectively implemented at a distance of over 100 m from the source, due to the constraints of the X-ray optical systems and equipment to be placed around the sample. In pilot studies, small extensions have been added to single beamlines (ID11 and ID13). However, the number of long beamlines foreseen within the science programme means that it is much more effective to add four large extensions to the existing experimental hall, each covering several beamline sectors. This expansion should be carried out in one operation to minimise costs and facility downtime. The new space (21,000 m²) will also be used to accommodate important new infrastructures and support facilities. Vibrational and thermal stabilities in the new extensions will need to be critically engineered in order to allow the nanometre-sized beam to be used reliably, as established in the pilot projects.

Improved and additional computing infrastructure ([chapter 3.3](#)) will also be required to fulfil the science of the Upgrade Programme. These enhancements will be aimed at optimising the entire experimental workflow from instrument control to data interpretation, transfer and archiving. Embedded systems will most certainly become commonly used for this purpose. A specific effort will be made to improve data analysis and scientific software. Online functionalities will allow experiments to be adapted on-the-fly by processing data as they are acquired. Increased storage capacity and off-line analysis tools will be developed that make use of modern technologies such as the Grid and high performance parallel computing. These computing developments will clearly benefit from European collaborative efforts. Adopting standard data formats will facilitate the work carried out by the different partners involved.

3.1. Accelerator and source developments

Science context

The scientific projects within the framework of the Upgrade Programme will strongly benefit from an enhanced ESRF X-ray source. The source will be upgraded to provide:

- Higher brilliance X-ray beams
- Higher flux X-ray beams
- Increased capacity for further beamlines
- Higher photon beam stability
- Increased insertion device (ID) flexibility.

These enhancements, whilst pushing the source to its limits, will not compromise the reliability and stability that the ESRF is renowned for and will maintain its key position in the hard X-ray range.

The Upgrade projects are based upon ongoing feasibility studies and include prototyping tests *in situ*. Implementation will be carried out sequentially, after each solution chosen has been validated, over the course of the ten year programme. The solid experience gained over the last decade on the evolution of the source will be used as a basis and installation will be performed in such a way that the accelerator will continue to operate in a highly reliable manner for the duration of the project period.

Added value of the Upgrade

Accelerator and source improvements will be the result of:

- Increasing the length of selected insertion device straight sections
- Canting selected straight sections
- Increasing the stored electron current with associated radio frequency power source and cavity upgrades
- Decreasing the vertical emittance
- Operating in "top-up" mode for time-structured modes
- Improved beam position diagnostics.

A more than two-fold increase in the photon flux will allow experiments to be performed more quickly. This is important for current and future flux limited experiments, which would otherwise take days, and will increase ESRF's capacity. Flexibility will be improved for the science programme to make optimal use of the sources and beamlines by enabling more undulators to be installed on each extended straight section. Finally, developments for the increasingly demanding science making use of the source time structure, will be reinforced.

The storage ring is at the heart of the ESRF. It is important to ensure its long-term durability and to do so, obsolete components must be upgraded. This concerns the replacement of klystron-type transmitters by solid-state power amplifiers. The present RF five-cell cavities will also be replaced by high order mode (HOM) damped room temperature cavities that will provide full beam stability at 300 mA and the possibility to further increase the current.

Studies will continue on a new lattice with a long-term objective of reducing the horizontal emittance and the production of ultra-short X-ray pulses.

3.1.1. Introduction

The ESRF X-ray source will be further enhanced over the coming years and will take advantage of the Upgrade Programme to make improvements which would not otherwise be possible and to push developments to their limits. These enhancements will provide X-ray beams of even higher brilliance and flux to permit new and better science to be carried out using the ESRF beamlines. Increased numbers of photons will also allow experiments to be performed faster, an important aspect for heavily flux-limited science where measurements can currently take days, thereby increasing ESRF flexibility and capacity. The proposed modifications of the X-ray source will provide:

- Higher brilliance
- Higher flux
- Increased capacity for further beamlines
- Higher photon beam stability
- Increased insertion device (ID) flexibility
- Enhanced durability of the accelerator complex.

These improvements will come as the result of increasing the length of selected insertion device straight sections, canting undulators, increasing the stored electron current, operating in a "top-up" mode and upgrading obsolete components of the accelerator.

Whilst a number of ~3 GeV synchrotron light sources have become operational recently or are under construction, it is clear that the ESRF with its higher electron energy will maintain a significant advantage in terms of brilliance in the hard X-ray range. This is illustrated in [Figure 3.1.1](#) where the current brilliance of the ESRF is compared to that of an in-vacuum undulator on the DIAMOND Light Source. Other light sources such as SOLEIL and ALBA will also provide less brilliant X-ray beams in this energy range.

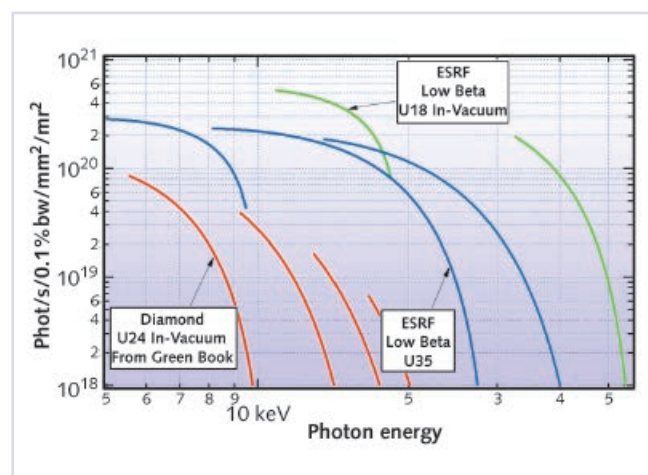

Figure 3.1.1: Brilliance in the hard X-ray range currently available at ESRF with 200 mA current compared to that of the Diamond Light Source at the nominal current of 300 mA.

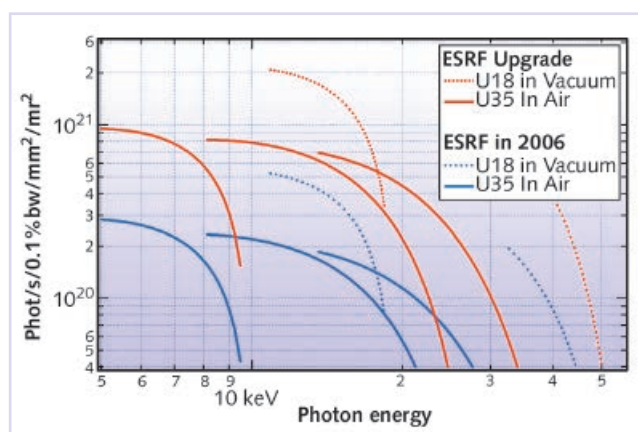

Figure 3.1.2: Brilliance of typical ESRF undulators before upgrades (blue curves) and after upgrades (increase in current to 300 mA, 7 m long insertion devices and lower vertical emittance) have been implemented (red curves).

Note that the gain in brilliance ([Figure 3.1.2](#)) is very similar to the gain in spectral flux since most of the increase comes from the augmented current and undulator length. A very important boundary condition for these developments has been strongly emphasised by the User Community, namely that improvements to the brilliance must not decrease the performance of the storage ring in terms of reliability and stability. Beam stability, a key to the success of the ESRF, is therefore an essential parameter for the upgrades of the storage ring. The ESRF is unique due to the large variety of available filling modes which range from uniform filling, $2 \times 1/3$ filling, $7/8+1$, 16 bunch and 4 bunch modes. All of these operation modes will continue to be delivered after the Upgrade as well as possible new filling modes required by new or refurbished beamlines for innovative science.

During initial discussions and simulations of new lattices for the ESRF using the existing tunnel, it quickly became clear that no satisfactory technical solution could be found to reduce the horizontal emittance. Any such change would also entail a considerable interruption of up to 2 years (shutdown and re-commissioning). In view of the many user communities relying on the ESRF to practice their science, such a period of time is considered to be too long. As a result, the upgrades to the ESRF accelerator and source will be made within a framework that avoids large-scale intervention on the storage ring in order to minimise disturbance to user operation, while still delivering significant increases in the quality of the source and the resulting X-ray beams.

3.1.2. 7 m Long insertion device straight sections

The lattice of the ESRF storage ring is of the Double Bend Achromat (DBA) type with 32 cells of alternating horizontal high and low beta values. The lattice was designed with two sets of quadrupole triplets located on both sides of the 5 m long insertion device straight sections to provide maximum flexibility and to allow the possibility of setting a wide range of beta values in the centre of the straight sections. In fact, this flexibility has never been used and it has been decided therefore to remove one quadrupole on each side and to use the corresponding space to enlarge the length available for insertion devices, from 5 to 6 m (Ropert *et al.*, 2006). This format has been tested and implemented in user support mode as from October 2006, simply by not powering the quadrupole magnets. The new lattice functions are presented in Figure 3.1.3. There are very small changes in the horizontal beta function and dispersion. The largest change concerns the vertical beta function in the second dipole which is increased from 35 to 45 m.

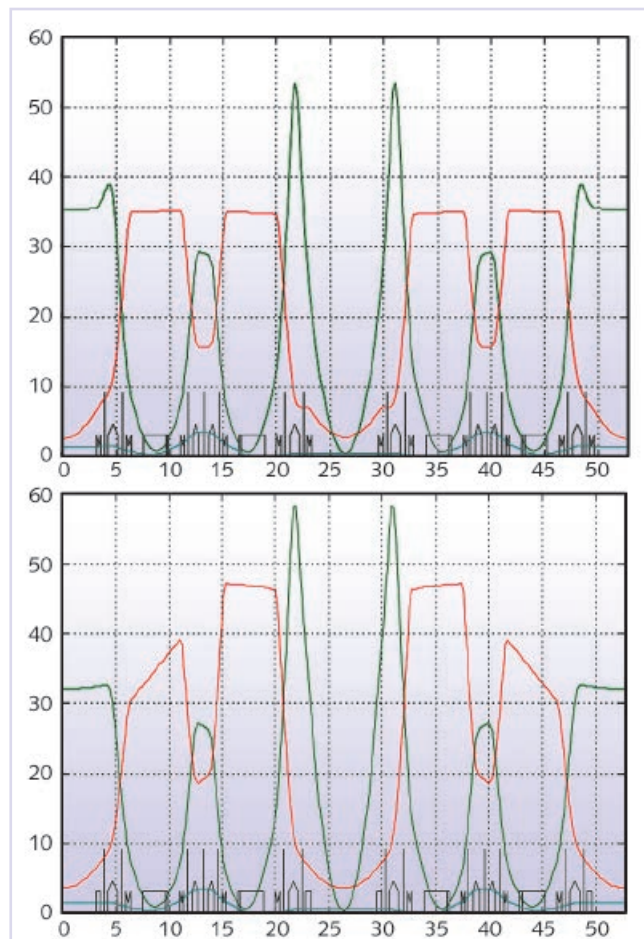

Figure 3.1.3: Horizontal β_x (in green), vertical β_z (in red) and dispersion (in blue) of the nominal lattice in 2006 (upper graph) and the new lattice without current powering the QD1 and QD8 quadrupoles (lower graph). The dispersion and horizontal β_x show very small changes whilst the vertical β_z is increased from 35 to 45 m in the second bending magnet.

To allow the current in the QD1 and QD8 family to be set to zero, the current in all of the other families of quadrupole and sextupole magnets was slightly changed as shown in Figure 3.1.4. Most modifications are minor and only required small changes to the power supplies.

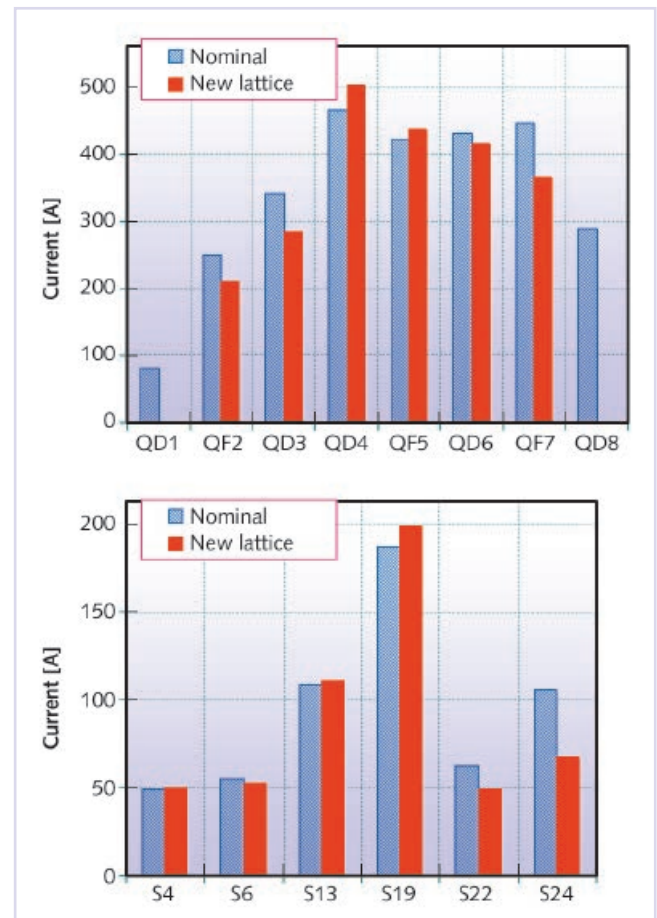

Figure 3.1.4: Modifications to the amount of current driving the quadrupole families (upper graph) and sextupole families (lower graph) between the nominal lattice in use earlier in 2006 (blue) and the new lattice (from October 2006) without current in the QD1 and QD8 families (red).

With zero current required in the QD1 and QD8 magnet families, these quadrupoles could be physically removed in the future, and longer insertion devices installed, once the corresponding vacuum chambers are changed. Furthermore, a second increase in the length of the available space for insertion devices, from 6 to 7 m, is possible by replacing two quadrupoles on both sides of the insertion device by shorter magnets and by displacing the adjacent sextupole as shown in Figure 3.1.5. This figure applies to a high beta straight section (ID-2, ID-4, etc.). The same would apply for a low beta straight with QD1, QF2 and QD3 instead of QD8, QF7 and QD6, respectively. The quadrupoles and sextupoles located on both sides of the 7 m undulator will require a different strength, and therefore a different current, than the other magnets of the same family. They will be powered by means of dedicated

power supplies. Some of the magnets will require new coils.

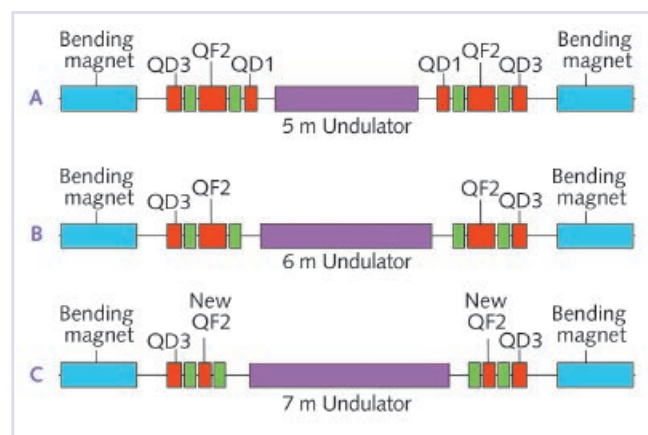

Figure 3.1.5: Schematic diagram of a high beta straight section. The blue, red and green elements are bending magnets, quadrupole and sextupole magnets, respectively. Case A represents the situation as in the first part of 2006 with a triplet of quadrupole magnets on both sides of a 5 m long undulator. The empty space between the undulator and the QD1 quadrupole is occupied by bellows, crotches and beam position monitors. Case B shows the first phase of modification consisting of the removal of the QD1 quadrupoles on both sides of the undulator, allowing the undulator length to be increased from 5 to 6 m. Case C shows the next step with the replacement of QF2 by a shorter quadrupole and moving the adjacent sextupoles closer leaving another metre (giving a final available length of 7 m) for undulator(s).

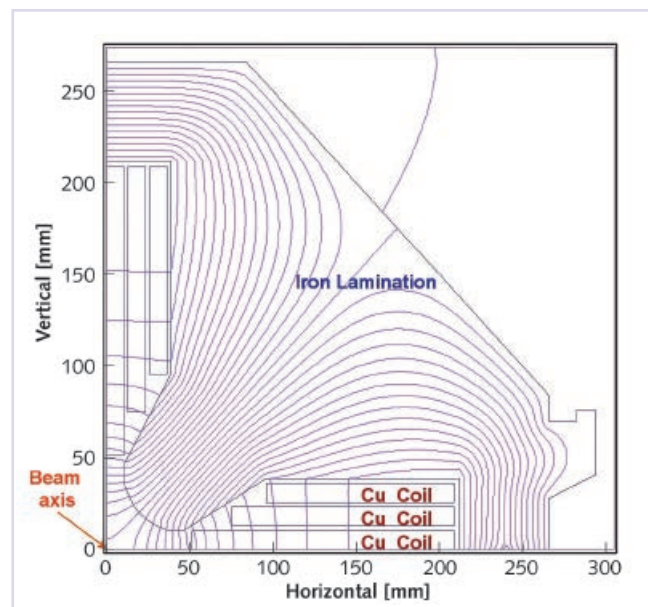

Figure 3.1.6: One-quarter of a section of a 35 T/m quadrupole showing the lamination profile and coil geometry. Unlike the existing quadrupoles which are limited to a 19 T/m gradient and have space available laterally for pumping ports, this quadrupole does not need any lateral space since it will be equipped with a constant cross-section vacuum chamber coated with non evaporable getter (NEG).

The alternating low and high beta undulator source points will be kept unchanged. To gain 1 m of ID length on the low beta sections, the modified QF7 quadrupoles need to have an operating gradient of around 30 T/m. A preliminary magnetic design for such quadrupoles has been carried out and is shown in Figure 3.1.6.

From both the beamline and accelerator point of view, 7 m long insertion device straight sections should be implemented on all straight sections. However, this would imply replacing 700 m of the ring vacuum chamber as well as removing and reinstalling all of the quadrupoles and sextupoles. Such an operation would be both costly and resource intensive, requiring a long shutdown as well as a lengthy reconditioning time once the installations were completed. A less disruptive option has been investigated, namely, to implement 7 m long straight sections on a limited number of sectors one by one, without long interruptions to the storage ring operation. However, such a lattice presents a broken symmetry and a possible consequence for the beam dynamics is a reduction of the dynamic aperture, resulting in a drop of lifetime and reduced injection efficiency. The proposed 7 m long straight sections cannot yet be fully tested experimentally since new quadrupoles and coils, as well as new power supplies, are required. Nevertheless, by locally re-powering the QD1 and QD8 quadrupoles, one can produce a symmetry break in the lattice that imitates that of a future 7 m long straight. Such tests were carried out in 2006 during machine dedicated time and will be continued during 2007. These tests have been quite successful. Studies have shown that the order of the most powerful resonances producing additional beam losses is of the odd type. As a result they largely cancel each other out by their excitation if two identical symmetry breaks are implemented 180 degrees apart around the ring circumference. In other words, it appears that if one takes the precaution of implementing 7 m straights in pairs located at 180 degrees from each other around the ring circumference, the reduction of dynamic aperture and the associated lifetime reduction will be limited. The implementation of a large number of such 7 m straight sections should be possible with minimal adverse effects on the lifetime and injection efficiency. The 7 m length made available could either be used to install longer undulators for a single beamline and increase the available brilliance, to add more flexibility by adding a portfolio of undulators with varied periods and/or lengths, or to be shared between two experimental stations using the canted undulator approach. The canting is made by horizontally deflecting the electron beam at both ends and in the middle of the insertion device straight section. Such canting had already been implemented on the ID23 beamline several years ago with a total canting angle of 2×0.75 mrad allowing two stations,

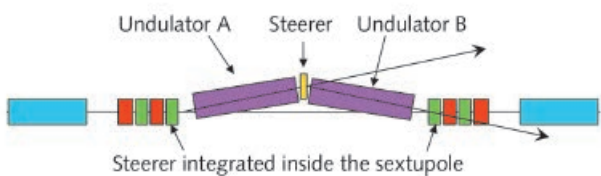

Figure 3.1.7: Schematic diagram of undulator canting. The angles in the figure are exaggerated to improve readability. The total angle between the beams from undulator A and undulator B will be close to 2×2.7 mrad. The canting is produced by means of three steerers located at the entrance, middle and end of the straight section. The entrance and end steerers will be implemented inside the existing sextupole magnets.

ID23-1 and ID23-2, to operate independently of each other. A schematic diagram of a pair of canted undulators is shown in Figure 3.1.7.

To simplify beamline design and instrument separation, a larger canting angle than that made on ID23 is desirable. A study has shown that a canted set of undulators with an angular separation of 2×2.7 mrad could be implemented. To maximise the space for the insertion devices, the steerers required to bend the beam will be integrated inside the sextupoles adjacent to the insertion device on both sides of the straight section. A short 0.3 m long permanent magnet dipole will be installed, located in the centre of the straight. With such a setup, two of the existing 1.65 m undulators (either the simple support structure or the revolver design which allows two undulator magnet assemblies to be switched during storage ring operation) or a 3 m long in-vacuum undulator may be

installed on each of the two segments of the chicane (Figure 3.1.8). Such in-vacuum undulators will be designed to accommodate cryogenic cooling allowing a 30% increase in the magnetic field (using existing NdFeB type material) for the same gap and period. Such a gain in magnetic performance will be used to extend the undulator spectrum to higher X-ray energies and/or increase the brilliance and tunability in the 10 to 30 keV range. As has always been the case at the ESRF, specific insertion device segments optimised to the needs of each beamline (polarisation, photon energy range, harmonic content, etc.) will be constructed and installed on the newly rebuilt straight sections.

Such an update requires the manufacture of a number of vacuum chambers for the ring and the beamline front-end as well as some new quadrupoles. It is expected that such upgrades to 7 m sectors will take place for one or two beamlines at a time during the long shutdowns of the ring such as those scheduled in winter and summer. The resulting impact on the beamline user operation will be minor.

3.1.3. Increased ring current and RF upgrade

Operation with 300 mA

Initially, the ESRF storage ring was designed for 100 mA of electron beam. During machine commissioning, the current was increased above 100 mA, and 200 mA has now been routinely

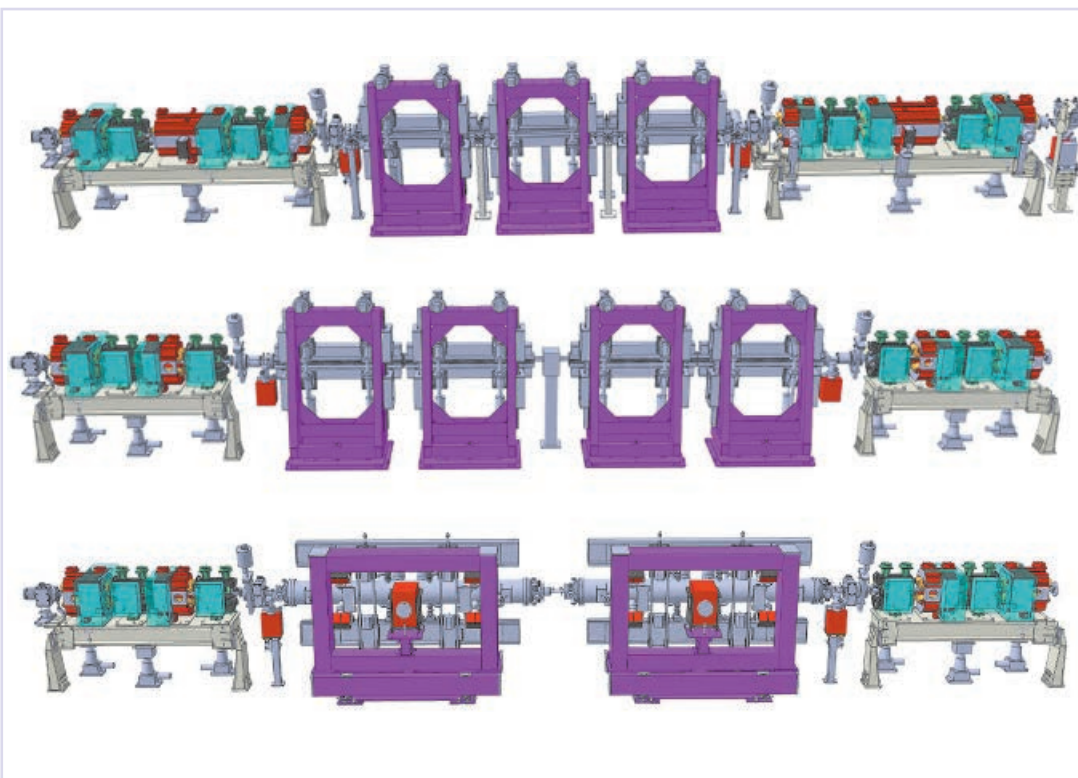

Figure 3.1.8: Layout of an insertion device straight section. The upper view shows the present situation with a 5 m straight section occupied by three undulators. The middle view corresponds to a 7 m straight section occupied by four standard in-air undulators (standard or revolver type). The lower view presents two 3 m long in-vacuum undulators occupying a 7 m straight section. The space between the two in-vacuum undulators could be used to install a steerer for canting.

delivered to users for many years. A bunch-by-bunch feedback system, presently under commissioning, has allowed stable operation at 300 mA in uniform filling mode for short periods of time during machine tests. This mode of operation, which still requires further tuning, optimisation and intensive tests, will become the standard operation mode in the years to come. All multibunch modes will be delivered with a stored current of 300 mA, including uniform, $2 \times 1/3$ filling and the new $7/8+1$ mode. The total current in hybrid $24*8+1$, 16 bunch mode and 4 bunch mode is limited by the wake fields induced by the beam in the vacuum chamber and will remain unchanged. At 300 mA, the stability of the stored current would rely on the combination of high order mode (HOM) detuning of the cavities through precise temperature regulation and optimum tuning of the feedback system. Whilst the existing radio frequency (RF) transmitter system can produce the required RF power for 300 mA operation, it does not provide any redundancy or operational margin as is presently the case with 200 mA stored current. For the upgrade, we propose to develop RF transmitters to restore redundancy and to replace the existing cavities with HOM free ones, with the objective of securing the longevity of the RF system.

The current RF systems

In the ESRF Storage Ring, each of the 6 GeV electrons loses 5 MeV of energy per turn, which is converted to synchrotron light. Under nominal conditions, the RF system generates 9 MV of accelerating voltage to re-accelerate the electrons and to provide a sufficient RF acceptance for an optimum lifetime of the stored beam. Since its commissioning in 1992, and in addition to the day-to-day maintenance and follow-up, the RF system has steadily been improved, including many developments which have allowed the stored current to be increased as well as considerably reducing the trip rate and beam down time. Whilst the booster RF transmitter (TRA0), the storage ring transmitters (TRA1 and TRA2) and their corresponding cavities were installed and commissioned before starting the accelerators in 1991/92, the third storage ring RF transmitter (TRA3), which is connected to a new pair of cavities in cell 25 of the ring, was commissioned in 1997 (see Figure 3.1.9). This upgrade allowed the increase in the nominal current from 100 to 200 mA with a sufficient operational margin and redundancy. In the years which followed, all of the older transmitters were refurbished one by one to a common design, which included the rebuilding of the local control system which had become obsolete and the addition of fast diagnostics for an improved maintainability and reliability. Such an upgrade was only possible thanks to the redundancy of the RF system which made it possible for any of the older

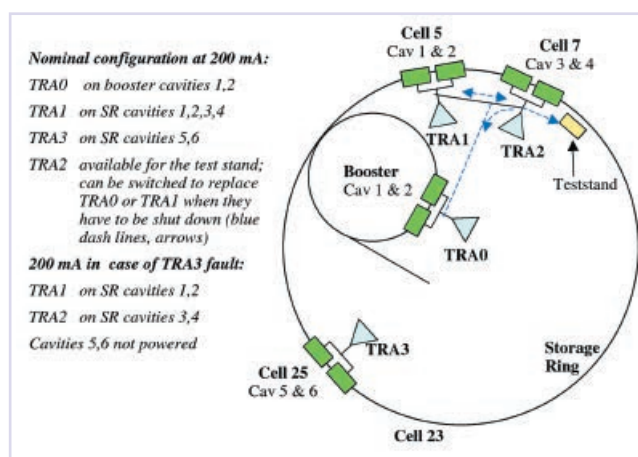

Figure 3.1.9: Sketch of the existing ESRF 352 MHz RF system using four 1.1 to 1.3 MW klystron transmitters TRA0, TRA1, TRA2 and TRA3. The booster is equipped with a pair of five-cell cavities, powered by the transmitter TRA0 with 500 kW pulses to provide 7 MV at the peak of the 10 Hz acceleration cycles. The storage ring is equipped with three pairs of similar cavities installed in cells 5, 7 and 25, which provide in total 8 to 12 MV of accelerating voltage (1.5 to 2.5 MV per cavity). In nominal configuration for 200 mA, only transmitters TRA1 and TRA3 are connected to the storage ring cavities. They transfer 1 MW of RF power to the beam, which converts it into synchrotron radiation. TRA2 is normally used to power the test stand in order to test or pre-condition spare parts (cavities, high power couplers, arc detectors, etc.), but a waveguide network with high power switches allows TRA2 to be connected to the cavities so as to safeguard the operation at 200 mA in case any of the TRA0, TRA1 or TRA3 transmitters have to be shut down.

transmitters to be shut down for periods of 6 months, without having to reduce the stored current during user operation.

The RF upgrade for the coming ten year period, proposed below, is derived from a similar strategy. The targets of the proposed upgrade are as follows:

1. Maintain the operation standard of the ESRF at a high level in terms of quality. To achieve this, it is mandatory to continue the well proven policy that consists of refurbishing aging equipment and replacing obsolete parts of the system with modern state-of-the-art technology.
2. Increase the photon flux and brilliance without compromising on the reliability and beam stability for an operation at 300 mA.
3. Carry out the necessary research and development to prepare for a possible further increase to 500 mA in the more distant future of the ESRF.

To achieve these goals, it is proposed to:

- i) Replace the klystron transmitters with solid-state power amplifiers.
- ii) Continue the development of a single cell cavity with strong Higher Order Mode (HOM) damping in order to replace the existing four-cell cavities of the storage ring.

The reasons behind these proposals are developed below.

Solid state amplifiers for the ESRF

The first objective of the RF upgrade deals essentially with the increasing difficulty in procuring good quality klystrons, which constitute the heart of the existing RF high power transmitter system. As demonstrated during fifteen years of operational experience, klystron instabilities constitute a large and the most unpredictable contributor to RF trips and RF down time. Moreover, the two manufacturers who supplied the most stable klystrons have stopped production, leaving a single supplier (who unfortunately produced the least stable klystrons) in a monopoly situation. A sudden change in the strategy of this manufacturer cannot be excluded, so there is a risk of obsolescence. The ESRF consumes about half a klystron a year and the last klystrons from this supplier were purchased in 1993 (last repair in 1999). Such a low purchase rate makes it difficult to convince the remaining manufacturer to improve the design. For the moment, the smooth operation of the ESRF is guaranteed thanks to a stock of eleven klystrons, although due to the stability issues discussed above, not all are suitable for storage ring operation (a number of them are only acceptable to power the booster cavities or the test stand). Altogether, assuming an average klystron lifetime of between 25000 and 35000 hours, the ESRF could be left without operational spares between 2010 and 2014, respectively. Confronted with these uncertainties concerning the klystrons, all of the new light sources developed in Europe (SOLEIL,

DIAMOND, ALBA) as well as the existing sources (ELETTRA, SLS) have been or are developing alternatives either based on Inductive Output Tubes (IOT) or high power solid-state amplifiers. IOTs are presently mass-produced for analogue television broadcasting but no IOTs are available (and there is no market) at the frequency of 352 MHz in use at the ESRF. Hence, the only identified alternative to klystrons is solid-state power amplifier technology. Following the extremely encouraging pioneering results of SOLEIL with their 190 kW transistor amplifiers (built up from many 300 W modules operating in parallel, [Figure 3.1.10](#)), it is believed by a number of RF experts that the modularity, stability and redundancy advantages brought by this new solution is a major breakthrough and is likely to set a reference for future high power RF generators.

The combination of hundreds of 300 W modules operating in parallel confers an extreme modularity and only a slight over-dimensioning yields an intrinsic redundancy, so that little additional available RF power should suffice to safeguard operations. Provided the right strategy for the procurement of spare power transistors is established, such solid-state amplifier systems should operate with near 100% reliability and availability: indeed an unusually small number of RF trips were recorded during the SOLEIL commissioning. Another advantage of transistor amplifiers consists of the 20 dB lower phase noise as compared to klystrons which is reflected in a more stable and jitter-free longitudinal bunch shape. With an overall efficiency of 50%, transistor amplifiers are comparable to klystrons, which are usually operated with a moderate 55% efficiency for an acceptable stability (compromise of efficiency versus stability). The price per unit RF power of solid-state amplifiers as built by SOLEIL is comparable with that of a 1.3 MW klystron-based transmitter (including klystron, high voltage power supply, auxiliary power supplies, etc.). However, contrary to the klystron case, the modularity of the solid-state amplifier allows the amount of installed power to be precisely matched to requirements.

In principle, the three existing storage ring RF transmitters can produce the necessary 3×700 kW RF power needed for 300 mA operation. However, this would require TRA1, TRA2 and TRA3 to be connected to their corresponding pairs of cavities (see [Figure 3.1.9](#)). This leaves no spare transmitter to back up the operation in case of a problem, and no available unit to power the test stand for high power component testing and cavity conditioning. In the frame of the RF system upgrade, it is therefore proposed to re-establish the same level of redundancy and hence reliability at 300 mA as is presently achieved at 200 mA, by adding RF power sources. A solution to achieve full redundancy with the klystron technology would appear to be inappropriate, as two



Figure 3.1.10: 8 x 50 kW solid-state power amplifier towers operated at SOLEIL, combining the power from 300 W modules with LDMOS-FET transistors in push-pull configuration. Such solid-state high power technology has been shown to provide a more stable system and is expected to have a longer lifetime than klystrons. It is planned to develop it for the ESRF in order to replace the klystron transmitters.

Courtesy of P. Marchand, T. Ruan, Soleil

more 1.3 MW klystron transmitters would have to be installed: one to back up TRA3 and one to either power the test stand or to back up the power transmitters TRA1, TRA2 or the booster transmitter TRA0. Solid-state amplifiers as described in the previous section constitute a more appropriate solution: their high modularity and their intrinsic redundancy would allow the corresponding amount of RF power to be installed for each cavity without having to anticipate the need for a back-up transmitter.

The first transmitter that would need to be backed up is TRA2 by feeding cavities 3 and 4 with the new solid-state amplifiers. On this occasion, these cavities could be moved from cell 7 to a position providing space for the new RF amplifiers, for example cell 23 (which can only accommodate a short beamline), thereby allowing cell 7 to be converted into an insertion device section available for a long beamline.

To summarise, the development and gradual implementation of solid-state RF amplifiers is not only the best way to establish high reliability at 300 mA, but it currently offers the only solution to protect the ESRF against the risk of obsolescence of the high power 352 MHz klystrons. According to the recent experience of SOLEIL, it would be realistic to expect a construction time of two years for the first 190 kW unit and a subsequent production rate of two 190 kW units per year. For full replacement of all of the klystron transmitters, sixteen 190 kW amplifiers would be required. For a future 500 mA operation, the solid-state amplifiers would just need the corresponding incremental power upgrade.

HOM damped cavities

Reliability of the day-to-day operation at 300 mA could suffer if it had to rely on the delicate combination of HOM detuning of the cavities through precise temperature regulation and optimum tuning of the longitudinal feedback system. It is therefore planned, on a medium timescale, to replace the existing five-cell copper cavities with a sequence of single-cell HOM damped room-temperature cavities, which will guarantee longitudinal stability over the full range of current from 0 to 300 mA even without feedback. The new cavities will be optimised for high beam power transfer and will fit into the existing RF dedicated straight sections of the ring. They will be designed to allow a further current upgrade to 500 mA. Keeping the RF frequency at 352.2 MHz is mandatory to allow a smooth, continuous and transparent upgrade of the existing RF system and will avoid having to replace all of the cavities at once as well as a number of critical beam diagnostics and the timing system. A normal conducting 352.2 MHz cavity with higher order



Figure 3.1.11: Normal conducting cavity with three attached ridge waveguides and ferrite absorbers for efficient HOM damping. The ESRF is actively engaged in collaborating with BESSY and ALBA to develop such a cavity for the ESRF Upgrade. a) 500 MHz HOM damped cavity on the Willy Wien Metrology Light Source. b) 352 MHz aluminium prototype in the ESRF RF laboratory.

Courtesy of E. Wehrle and F. Marhauser, BESSY

mode damping is presently being designed at the ESRF. The study is being carried out in the frame of a collaboration with BESSY and ALBA, including the exchange of simulations and prototype measurements. The proposed new ESRF cavity will be similar to the one shown in [Figure 3.1.11a](#), which is installed at the Willy Wien Metrology Light Source in Berlin and which is also being manufactured for ALBA.

Compared with the cavity built for the Willy Wien Metrology Light Source, a cavity optimised for the ESRF has relaxed HOM damping requirements, which gives room for an improved accelerating mode impedance. This has been confirmed by measurements carried out at the ESRF on the aluminium model of [Figure 3.1.11b](#). It is proposed to replace the 6 five-cell cavities installed in pairs in the long straight sections of cells 5, 7 and 25 with a total of eighteen such single-cell cavities: six per straight section. Even at 500 mA, each of the eighteen cavities will only be fed with 170 kW of RF power, which is conservative in terms of RF window power and corresponds to one SOLEIL-type solid-state amplifier.

The installation of six 352.2 MHz SOLEIL-type superconducting cavities, built in three cryo-modules occupying three straight sections, is another option being studied. In order to transfer the higher power to the beam, as compared to that required at SOLEIL, a modified version of this cavity equipped with a second power coupler would need to be developed for the ESRF. This would easily allow the 1.5 MW of beam power to be sustained at 300 mA, but for a further upgrade to 500 mA with 2.5 MW of beam power, the couplers would be operated at their upper power limit. Moreover, even if the additional investment of the cryogenic plant would largely be compensated after ten years by electrical power savings thanks to the lossless superconducting cavities, this option would imply additional operational and maintenance effort as well as an increased risk of longer lasting interruptions in case of faults. For all these reasons, the superconducting solution is not the preferred one.

Note that both axes of the RF upgrade, the implementation of new cavities and the replacement of klystrons with solid-state amplifiers, are almost independent of each other. Only the number of combined amplifier modules per cavity and to a minor extent the total RF power will be slightly different for the new cavities (3 x 6 couplers) as compared to the existing cavities (3 x 4 couplers).

3.1.4. Top-up operation

The implementation of injection with front ends open in 2003 has improved the stability of the beamline optics due to the uninterrupted availability of the X-ray

beam. Thanks to the long life time in multibunch mode, only two short refills are performed per day with the present machine configuration. Between each refill, the beam is delivered for 12 h, with a maximum current change of 15%. In contrast, the larger current variation during decay makes a frequent injection (top-up) attractive for the time-structured modes (16 and 4 bunch modes) since the time-averaged current will be increased greatly as well as improving beam stability for the beamline optics. These time-structured modes, as well as the hybrid mode, must be delivered with a high contrast of 10^9 between the filled bunches and the empty bunches. The process of removing the low populated bunches required for a 10^9 contrast is commonly referred to as "cleaning". It is currently achieved in the storage ring immediately after injection by selectively exciting and intercepting the low current bunches in the vertical plane, making use of the variation of the vertical tune with the bunch current. Several solutions are under investigation to perform the cleaning process in the booster and to avoid such an undesirable excitation of the beam each time the refilling takes place in the storage ring. This includes the possible operation of a 1 Hz injection cycle of the booster synchrotron following an upgrade of the booster power supply system. Special care will be needed to minimise disruption to the beamlines induced by the injection bump. The most serious is the non-closure of the bump for some of the bunches due to the sextupole magnets located inside the steerers which drive the injection bump. These sextupoles will be powered independently with dedicated power supply in order to resolve this.

3.1.5. Lowering the vertical emittance

The vertical emittance achieved so far in routine operation of the ESRF is around 25 pm in 2 x 1/3 filling mode. The emittance is voluntarily increased to a higher value in 16 bunch and 4 bunch modes in order to increase the lifetime, which will not be necessary once top-up operation is implemented. Shrinking the vertical emittance not only increases the brilliance, but it also reduces the spot size on the sample after refocusing which is of immediate benefit for nanobeams. The long-term operation at a smaller vertical emittance is limited by several issues. Some ions (generated directly or indirectly by synchrotron radiation) get trapped in the electron beam and produce an increase in the emittance; this effect is particularly severe in uniform filling mode but can be managed by means of the vertical bunch-by-bunch feedback. Another limitation is the residual skew quadrupole field which evolves with time as the magnetic gaps of the undulators are changed by the beamlines. To remove these emittance fluctuations induced by the insertion device gap changes, an active correction needs to be put in place. To this

end, new vertical emittance diagnostics are currently being implemented in order to provide a shorter response time. Additional skew correctors will also be implemented that will allow a stabilisation of the vertical emittance at around 10 pm in all filling modes with possibly lower values in the less sensitive filling modes such as $2 \times 1/3$ filling mode.

3.1.6. Other developments

Beam position monitoring and diagnostics

A number of diagnostics will be further developed with particular emphasis on low noise beam position monitoring with a view to improving the beam position stability further. In particular, the electronics controlling the button-type beam position monitors will be upgraded to make use of digital signal processing. A particularly critical issue in the electron beam monitoring is the closure of the trajectory in the storage ring after the first turn following injection. The present system performs well at high current but suffers from inefficient and imprecise position readings at low current in the first turn mode of operation (3 μ s after injection). To achieve a suitable level of precision for first-turn beam position monitoring, the maximum current from the injector and four shots of electrons are required. During injection tuning, this injected current is continuously lost in the ring tunnel and generates radiation dose levels in the experimental hall which are no longer compatible with the regulations in force. Ground settlement has been rather slow on the ESRF site and, as a consequence, the first turn retuning has not been required over the years in as far as the steering configuration is saved and reloaded before and after each shutdown of the accelerators. This may not be the case with the forthcoming building construction programme. Such difficulties have been well mastered in the recently built third-generation light sources such as DIAMOND and SOLEIL thanks to digital signal processing. Updated beam position monitoring systems will present other advantages, for example, allowing all beam position monitors to be used for a global position feedback and therefore giving the opportunity to further enhance the vertical beam stability. They will also allow a precise diagnostic of the beam dynamics close to the stability limit and provide a unique tool for further improving the lifetime and injection efficiency.

Prototyping components for 500 mA operation

Another development is to prototype and test storage ring vacuum chambers as well as crotch absorbers capable of withstanding a 500 mA current (see also [section 3.1.3](#) above on the RF upgrade). In particular,

concerning the vacuum system, new extruded aluminium chambers with Non Evaporable Getter (NEG) coating are proposed for the new shorter quadrupole chambers located on both sides of the 7 m long straights. Thin heaters, developed at CERN, will be used for the activation of the NEG. The main advantages of this solution are a reduced number of lumped pumps and reduced constraints in the quadrupole design allowing a higher magnetic field gradient.

3.1.7. Short bunches: production of ultra short X-ray pulses

Another challenging request coming from several ESRF beamlines is for the production of pulses of hard X-rays with a duration much shorter than the 40 ps rms available at present. This would allow for experiments with a faster time resolution. Several schemes have been proposed worldwide to provide picosecond X-ray pulses from storage rings. One scheme, based on interacting a femtosecond laser resonantly with the electron beam inside an undulator, is in use at BESSY, SLS and ALS (Zholents and Zolotarev, 1996; Schoenlein *et al.*, 2000; Khan *et al.*, 2006; Streun *et al.*, 2006) in the soft X-ray spectrum. Another scheme based on the longitudinal-vertical streaking by a transverse RF cavity (crab cavity) and the isolation of a short slice of the undulator radiation from such a swept pulse, was proposed several years ago and would seem more appropriate for a high electron energy source like the ESRF (Zholents *et al.*, 1999). A third, much simpler scheme of producing a longitudinal-vertical tilting electron pulse through the excitation of vertical head-tail modes by means of kickers has been proposed recently (Guo *et al.*, 2007). The application of these schemes to produce picosecond X-ray pulses at the ESRF will be explored. Once a suitable technical solution that satisfies user requests has been identified, it will be studied in detail and implemented.

3.1.8. The future beyond the ESRF Upgrade

A recurrent request from ESRF beamlines concerns the reduction of the horizontal emittance. With the constraints of re-using the same tunnel and infrastructure, extensive lattice studies have not yet provided a satisfactory means of decreasing the horizontal emittance of the ESRF storage ring. Studies of a longer term design for a new higher brilliance lattice will be pursued, with a view to providing an effective emittance of less than 1 nm with the

constraints of keeping the tunnel and beamlines in place. Possible magnetic structures are a triple bend achromat (TBA) lattice or a double bend achromat (DBA) lattice similar to that currently in use but with special bending magnets providing a variable magnetic field along the beam path. A number of challenging issues are raised by these new designs. The correction of the aberrations induced by the increased focusing necessitates the use of much stronger sextupole magnets, resulting in a small dynamic aperture to the beam as well as requiring advanced magnet design. It is not expected that such a scheme will come to maturity within the near future. Research and development will be needed to optimise and develop advanced magnet designs and to be able to understand the non-linear optimisation of lattices.

Another method to reduce the horizontal emittance is to use damping wigglers such as in the Petra III and NSLS II projects. Preliminary studies show that it is possible to achieve a horizontal emittance of 0.2 nm at 6 GeV in a storage ring with a circumference of around 1400 m (the current ESRF ring has a circumference of 844 m) while retaining a large dynamic aperture and without the need for a sophisticated magnet design. Such a scheme would certainly be a competitor to the recently proposed energy recovery linac (ERL) scheme based on superconducting linac technology, optimised lattice design and re-circulation.

Such an ultimate Hard X-ray Source whether of storage ring or ERL type will also be further developed with a view towards designing a facility to be built somewhere in Europe or elsewhere in the world.

Besides this, there is another area which deserves close attention, namely the design and optimisation of high performance table-top X-ray sources. Such sources are likely to come at a reduced cost, and performance compared to that of a high energy storage ring. Thanks to their affordability, they could be acquired by a large number of academic and industrial institutions and therefore have a major impact on X-ray science.

References

- Guo W., Yang B., Wang C.-X., Harkay K., and Borland M. (2007), Generating picosecond X-ray pulses in synchrotron light sources using dipole kickers, *Phys. Rev. ST Accel. Beams*, **10**, 020701.
- Khan S., Holldack K., Kachel T., Quast T., and Mitzner R. (2006), Operation of the first undulator-based femtoslicing source, *Proc. EPAC 2006*, 154.
- Ropert A. and Farvacque L. (2006), Optimisation of a new lattice for the ESRF storage ring, *Proc. EPAC 2006*, 1942-1944.

- Schoenlein R.W., Chattopadhyay S., Chong H.H.W., Glover T.E., Heimann P.A., Leemans W.P., Shank C.V., Zholents A., and Zolotarev M. (2000), Generation of femtosecond X-ray pulses via laser-electron beam interaction, *Appl. Phys. B*, **71**, 1.
- Streun A., Al-Adwan A., Beaud P., Böge M., Ingold G., Johnson S., Keller A., Schilcher T., Schlott V., Schmidt T., Schulz L., and Zimoch D. (2006), Sub-picosecond X-ray source femto at SLS, *Proc. EPAC 2006*, 3427.
- Zholents A.A. and Zolotarev M.S. (1996), Femtosecond X-ray pulses of synchrotron radiation, *Phys. Rev. Lett.*, **76**, 912-915.
- Zholents A., Heimann P., Zolotarev M., and Byrd J. (1999), Generation of subpicosecond X-ray pulses using RF orbit deflection, *Nucl. Instrum. Methods A*, **425**, 385-389.

3.2. Buildings and Infrastructure Extensions

Science context

The scientific projects foreseen within the framework of the Upgrade Programme require the ESRF experimental hall to be extended in order to accommodate lengthened beamlines. This will allow a greater demagnification ratio, improved space around sample positions and new laboratory and office space housing an improved range of support including complementary sample characterisation services. The computing developments that will take place as part of the Upgrade will require a new data centre to be created containing updated computer clusters, network devices, and data back-up and archiving systems.

The extensions are an absolute prerequisite for carrying out the long beamline projects. They are therefore a limiting factor in the project planning. To drive the project forward, the ESRF has already initiated a number of preparatory steps by defining the shell of the extended experimental hall (and thereby which storage ring sectors may be used to hold long beamlines) and undertaking a pre-qualification exercise to select companies able to tender for the architectural and engineering design work. One of the major constraints given to the architects will be to plan work to give minimal downtimes of the facility.

Added value of the Upgrade

The ESRF Upgrade Programme therefore includes a substantial extension to the existing experimental hall which will be enlarged in the areas where this is possible (given the site constraints):

- 21,000 m² of total new surface will be created (equal to about an additional one-third of the current ESRF usable surface areas).
 - Of this, 14,000 m² will allow 16 beamlines to be increased in length from 55 m between the source and sample to, in most cases, between 120 and 140 m. This space will also be used for additional laboratories close by the beamlines and will also house the data centre (500 m²).
 - Of this, 7,000 m² will be for new infrastructure, laboratories (chemistry, biology, high pressure, clean rooms, etc.) and office space.
- The spatial resolution of many experiments on the ESRF beamlines will pass from the micrometre to the nanometre range. This progression will have significant requirements concerning the long beamline stability. The extension design efforts will therefore be concentrated on limiting the vibrations transmitted to the sample and associated support structures and on developing a thermally stable environment appropriate for the beamline hutches.
- The high magnetic field laboratory component of the Upgrade has special requirements concerning infrastructure and, in particular, the power supply. This will be a shared resource between the ESRF and the ILL (Institut Laue Langevin) and the 20 to 40 MW electrical power supply necessary for the static high field magnets will be located between the two institutes. A cooling capacity (1200 m³/h water cooling) will also be installed.

3.2.1. Introduction

This chapter describes the design, key concerns and the steps needed to create the new buildings and infrastructure within the framework of the ESRF's scientific and technological Upgrade Programme. The new building shell setting the boundary conditions for the extensions (including the extension of the existing experimental hall) was designed with the aim of accommodating new scientific needs and providing the space for extended beamlines and facilities. The planned tendering exercise for the architect and engineering team to complete the design of the extensions may result in refinements to the building shell to take into account specific engineering or aesthetic conditions.

The ESRF, ILL and EMBL (European Molecular Biology Laboratory) are the three independent institutes located on a common site within the "*polygone scientifique*". Their site security, site entrance, telephone, and restaurant facilities are shared. The constraints inherent to the construction on site will be taken into consideration in the development of this project. The ESRF currently leases a surface of about 25 hectares (62 acres) with a useful surface of currently about 73,000 m². The majority of this is dedicated to laboratories producing and using synchrotron radiation (Figure 3.2.1).

When planning for the new buildings and infrastructure, the following points must be taken into account:

- Due consideration must be given to existing site constraints such as site boundaries, existing buildings and the current infrastructure.
- User operation downtime caused by the building works must be minimised.
- For a maximum number of beamlines, given the site constraints, the distance between the source point and the sample shall be extended to the largest reasonable distance (at present 55 m; whereas 120 to 140 m is desired for the extended beamlines). This will require radial extensions to the experimental areas, where possible.
- Beamlines ID16 to ID19 should retain the status of "potentially extra-long beamlines": the areas already set aside in case of future prolongation of the lines will not be encroached upon.
- The extension project will triple the available office and laboratory space in relation to that lost in the creation of the extended areas (for example, lost ground floor laboratories through which beam flight tubes pass and first floor offices that become windowless).

There are four areas where extension to the experimental hall is possible whilst, at the same time, incorporating the construction conditions highlighted

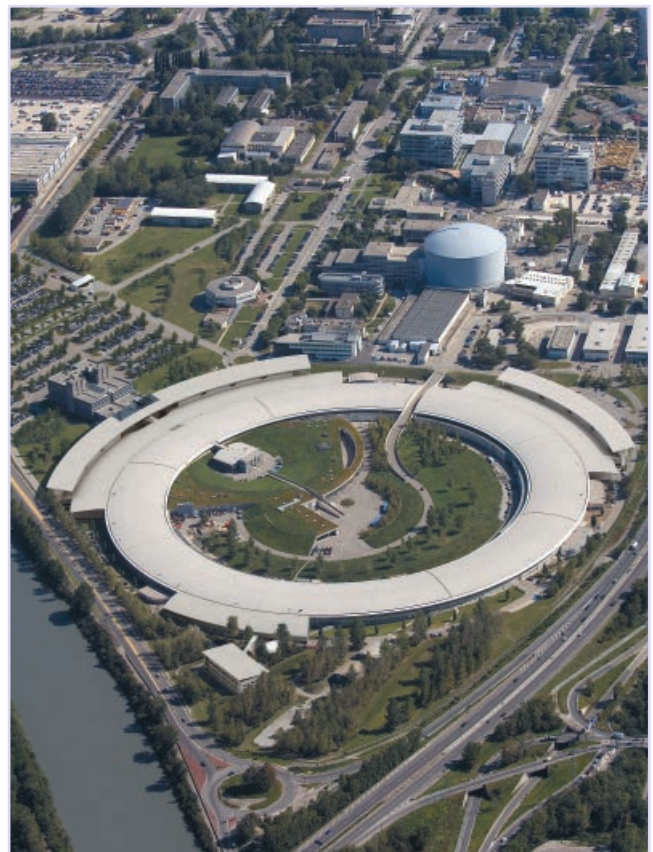

Figure 3.2.1: Layout of the existing site (left) and artist's impression of the ESRF post-upgrade (right).

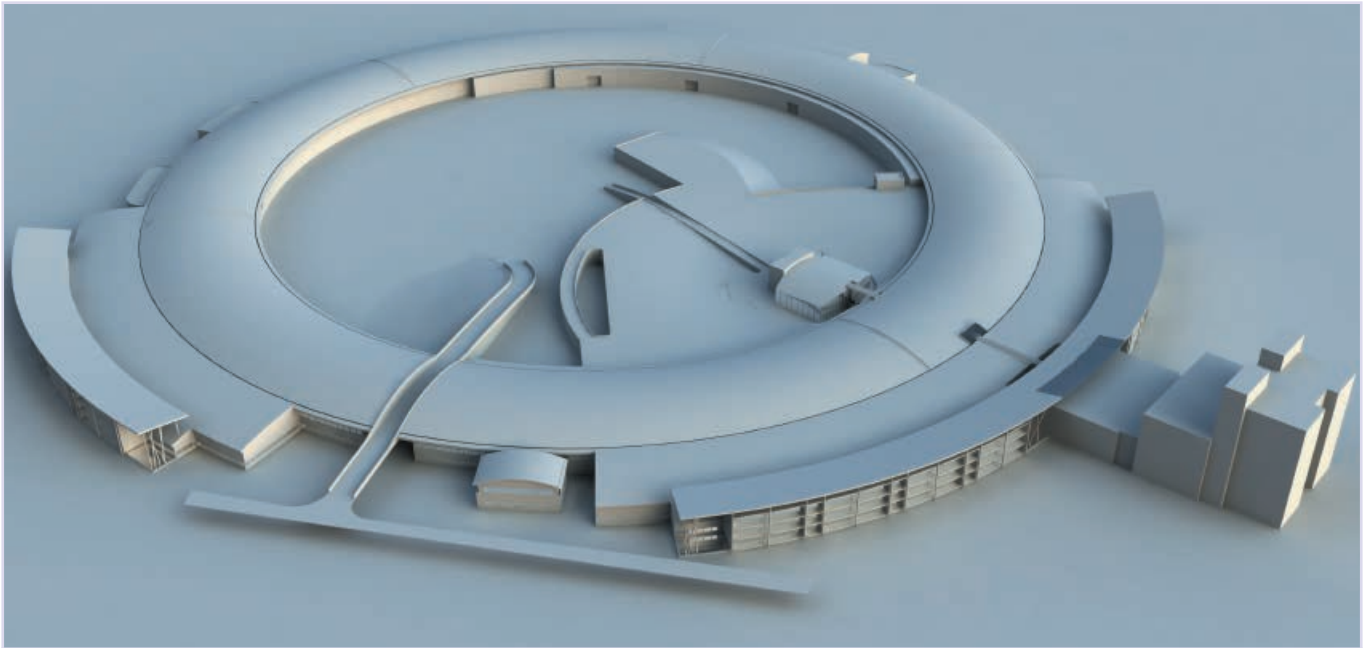

Figure 3.2.2: Artist's impression of the experimental hall extensions.

above. These areas are named Vercors, Chartreuse and Belledonne (after the mountain ranges surrounding them), and Peninsula. The surfaces created will amount to about 21,000 m² (Figure 3.2.2 and Figure 3.2.4).

3.2.2. Creating new space

Scientific needs

The extended length beamlines need to fulfil certain requirements, which can be grouped into the two categories of X-ray optics and space. Some projects fall into both categories.

- **Optical requirements: Very large or very small beams and coherence**

Topography, tomography and medical imaging require beam sizes of up to several centimetres. The experimental stations of ID17 (CDR: CPR) and ID19 (CDR: IMPACT) are therefore already located in external satellite buildings. Furthermore, phase contrast imaging techniques are increasingly being used; these techniques rely on the coherence of the X-ray beam. Optimum performance is only achieved on long beamlines, as the length of the transverse coherence increases linearly with distance from the source (CDRs: CPR, IMPACT, SFINX). Focusing to very small spot sizes also requires long beamlines. This is illustrated in Figure 3.2.3, which presents a simplified diagram of a single, perfect focusing element or "lens". The source is demagnified by the ratio of the distance from the lens to the sample and from the source to the lens, q/p . In practice, q cannot be decreased beyond a certain limit determined by the diffraction limit and the experimental apparatus, typically, the sample

environment or goniometer mechanics. For a given source size, the only remaining way to decrease the focal spot size is to increase p . In theory, a small beam could also be produced using a more complicated optical arrangement on a shorter beamline. In practice, however, the number of X-ray optical components should be restrained whenever possible in order to minimise image degradation from sources such as mirror slope errors, absorption in refractive elements, and thermal and vibrational stability. Notably, most requests for long beamlines are centred on nanofocusing applications (*e.g.* CDRs: HXPM, MATSCI, MINADIF, MXBIB, NRS-NSM, SFINX, SMILE).

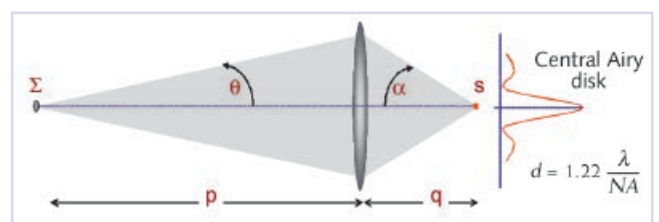

Figure 3.2.3: Optical demagnification: Assuming perfect imaging, the size of the focal spot, s , is given by the size of the source, Σ , multiplied by the distance from the focusing element to the focal spot, q , and divided by the distance from the source to the focusing element, p . The minimum spot size is limited by the geometrical demagnification, $s_G = \Sigma \times q/p$ and the diffraction limit, $s_{DL} = 1.22 \lambda / \sin \alpha$.

- **Space requirements**

In addition to the optical requirements, long beamlines may be necessary to take into account the potential constraints connected to the size of the sample environment or the location of the experiment. In particular, on canted beamlines,

sufficient space for the installation of the optical elements and other instrumentation may only be available far from the source, due to the small angle between the two beams. For certain experiments, specific sample preparation and support prerequisites, such as high magnetic fields or chemical and biology laboratories, need sizeable areas available near the beamline experimental hutches.

Consequences for existing buildings and premises

Preliminary studies on the extensions carried out by the ESRF during 2005 and 2006 have set the construction boundaries for the project as detailed below:

The extension of the beamlines will be integrated into the four areas of Belledonne, Vercors, Chartreuse and Peninsula. The extensions are shown on the location plan (Figure 3.2.4). The radial cross-section (Figure 3.2.5) shows the general layout of the extensions with a section of the office/laboratory areas on the periphery. Table 3.2.1 presents details of the surfaces created and lost through the project categorised by type (beamline areas, offices/laboratories).

Extension of beamline experimental areas

Table 3.2.2 lists the sectors that can be extended within the constraints imposed by the ESRF site and its existing infrastructure. The length value presented is the potential maximum length of the experimental area from the source point to the most exterior lead wall.

Beamlines ID6, ID8, ID9, ID27, ID28, and ID29 will be extended into the Vercors and Chartreuse areas with the radius from the experimental hall increased by 26 m to incorporate the useful experimental area, bringing the potential average experimental area length to 125 m along the beam axis. ID10 will also benefit from the Vercors extension with a potential length of 110 m, limited by the non-constructible zone along the motorway. ID07 has the potential to be extended into the Vercors area. However, its sector on the storage ring is currently occupied by an RF cavity essential for storage ring operation. The RF cavity could be moved, depending on the choices

made within the framework of the X-ray source upgrade (see chapter 2.2).

ID01, ID02, ID31, and ID32 will be extended into the Belledonne area with a 35 m increase in radius from the experimental hall for the useful experimental area. The potential experimental area length will be about 140 m for ID01, ID32, and ID31, and about 115 m for ID02. The multilayer laboratory, housed in the existing building in Sector 03-7, will remain intact. This laboratory was only recently constructed and put into service.

Beamlines ID20, ID21, and ID22 will be extended into the Peninsula area with an increase of 14 m in the radius from the experimental hall to incorporate the useful experimental area. The experimental area length will be about 110 m for ID20 and ID21 and 105 m for ID22.

ID30 lies between the Chartreuse and Belledonne extensions and the central building. It has the potential to be extended, but the final length of this extension is not currently known since it will depend on the architectural choices made for both the Chartreuse and Belledonne extensions.

The new extensions and their experimental areas will be serviced by a six-ton overhead crane at a height of 6.5 m under the hook in the standard areas and 8.5 m in the Vercors area for the high magnetic field facility. These overhead cranes will be used for the construction of lead hutches and for future operational needs such as the handling of scientific instruments. The architectural design of the extensions will therefore be expected to optimise and simplify their use.

Other new areas

• New office and laboratory space

Each of the four new extension areas will contain significant areas allocated to offices and laboratories. Indeed, it is foreseen that new office and laboratory space will be created that is three times larger than the office and laboratory space lost as part of the construction process. The laboratories and offices will

| | Chartreuse | Belledonne | Peninsula | Vercors | Total |
|---|--------------|--------------|--------------|--------------|---------------|
| New office and laboratory spaces (m ²) | 2,160 | 1,080 | 2,400 | 3,300 | 8,940 |
| Beamline areas (m ²) | 3,685 | 4,940 | 1,540 | 4,700 | 14,865 |
| Total area created per extension (m²) | 5,845 | 6,020 | 3,940 | 8,000 | 23,805 |
| Lost office/laboratory spaces (m ²) | 635 | 770 | 675 | 890 | 2,970 |
| Total gain in area (m²) | 5,210 | 5,250 | 3,265 | 7,110 | 20,835 |

Table 3.2.1: Building shell surface estimates in m² and comparison with areas lost during construction.

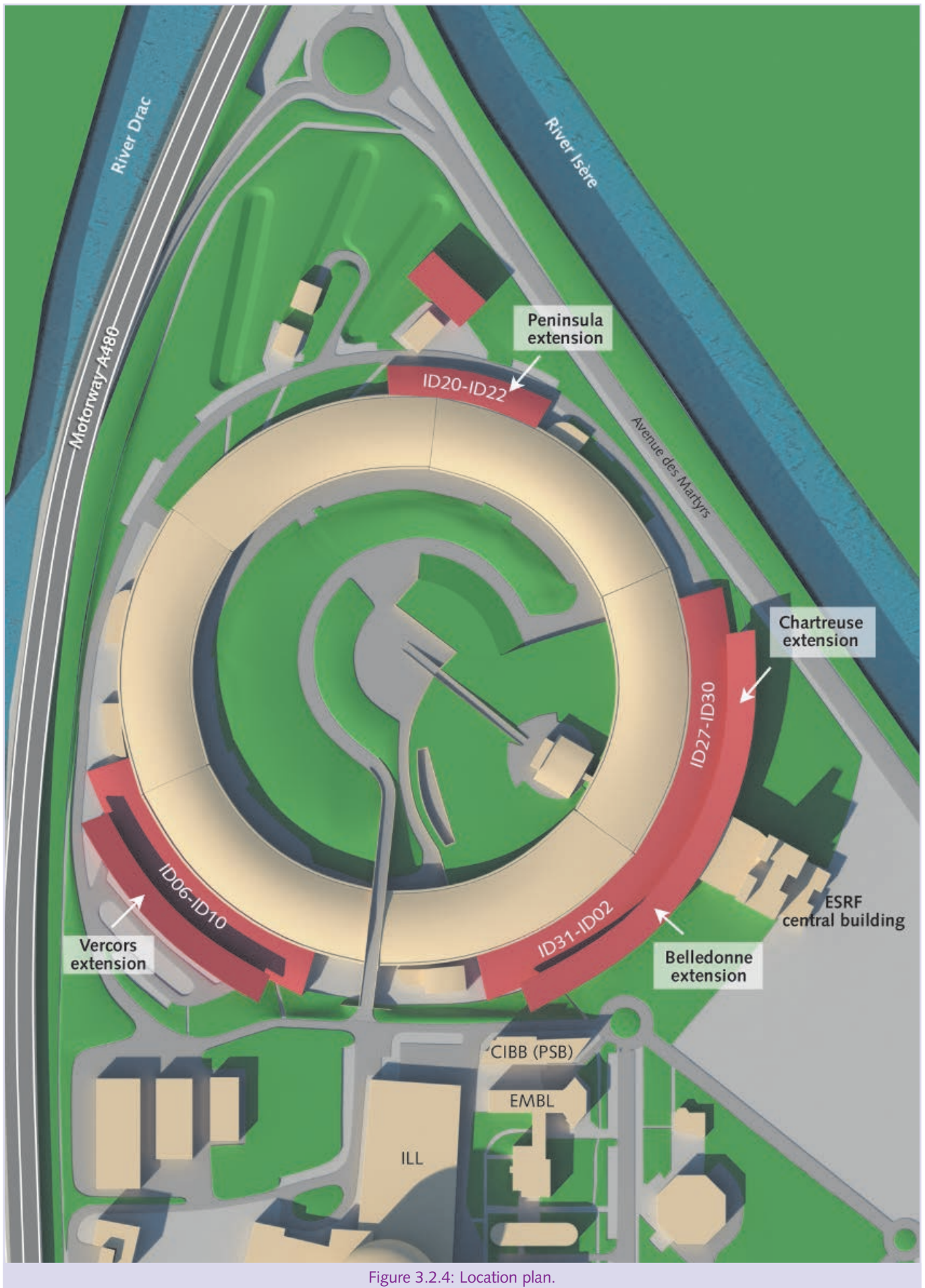

Figure 3.2.4: Location plan.

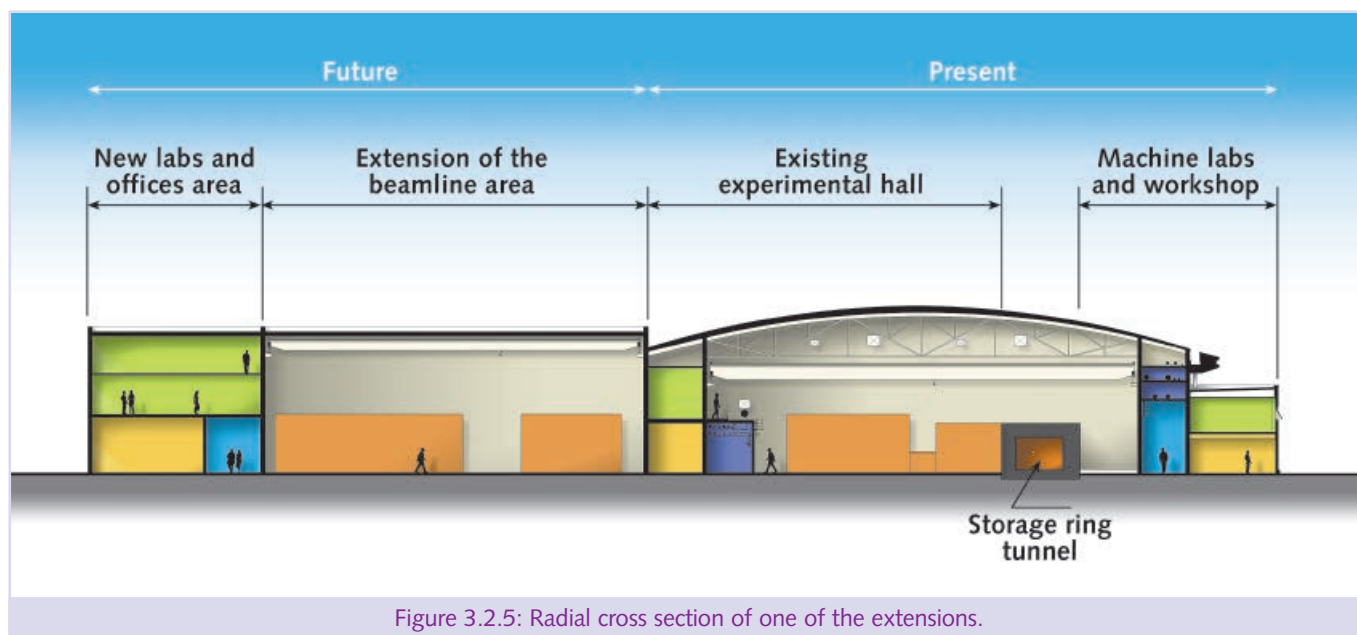

Figure 3.2.5: Radial cross section of one of the extensions.

be located at the periphery of the extension areas, with laboratories housed on the ground floor and offices on two upper levels (Figure 3.2.5). New laboratories and office areas cannot be built in the Peninsula extension periphery due to the layout of the site. This should be seen as a positive point as, ultimately, it avoids construction close to the areas reserved for the very long (up to 250 m) beamlines, ID17 and ID19.

• Data centre

Data storage, tape back-up devices, high performance clusters and a significant amount of network electronics are currently installed in two distinct, separate computer rooms. The current ESRF infrastructure is close to saturation and new space will be required for the additional storage, back-up, and processing power needed to hold data from the new science originating from the Upgrade Programme over the next ten to twenty years (see chapter 3.3 for more details).

A new data centre would supersede most of the functional aspects of the original Central Building computer room. Only half of the network equipment (about ten 19" racks) has to remain in the Central Building location. The main characteristics of the new data centre will be:

- Surface: 500 m²
- Useable height: 250 cm
- UPS power: 500 kW
- Air conditioning: 750 kW (including a 250 kW reserve)

The surface area (500 m²) required by the new data centre will be integrated into one of the extensions to the experimental hall close to the existing computing rooms currently located in the Central Building and control room.

• The high magnetic field facility

There are plans to create a high magnetic field (HMF) installation on the ESRF site, with field coils on the ID06 and ID08 beamlines (these fields will be over 30 T). An installation in collaboration with the ILL and CNRS is foreseen for the electrical power supply (20 to 40 MW) and cooling. This section provides only a brief overview of the installation, which requires an in-depth investigation before being finalised (see section 2.4.5 on Experiments under Extreme Conditions for more details).

An open cooling network will be created by pumping water from the Drac river to the primary circuit of the heat exchangers. Independent secondary circuits containing demineralised water will connect the heat exchangers to the magnetic facilities of both the ESRF and the ILL. The secondary circuits will contain powerful pumps able to cope with the high volume and pressure (1200 m³/h and 28 bar) required for the cooling circuits of the magnets.

These services will be installed in a utilities building of about 1200 m² common to the ESRF and the ILL, accommodating the pumps and heat exchangers, power supplies, electrical transformer and distribution sub-stations (this is not within the scope of the ESRF Upgrade Programme).

The Vercors extension will accommodate the ID06 and ID08 beamlines with a height of 8.5 m under the hook of the overhead crane to make the manipulation of coils and their associated equipment (*e.g.* sample holders) possible. Coils will be situated in pits on the experimental floor, centered on the X-ray beam axis due to their large size. In addition, the liquefier, using helium recovered from the closed cooling circuit of the magnet (flow rate of about 60 to 80 l/h for hybrid

magnet cooling), could be installed close by in the beamline area.

Interface with existing buildings

Construction of the extensions has been simplified by the decision to only build lead hatches outside the current existing structure at the edge of the experimental hall, where offices and laboratories are currently located. This will minimise disruption to normal ESRF operation and means that the area does not need to be serviced by an overhead crane so that the existing load bearing structure can be preserved (Figure 3.2.5). Several advantages of this are detailed below:

- Only minor modifications to the existing hall will be required to permit beam flight tubes for the longer beamlines.
- The surfaces of the offices located on the first floor in the sectors will be maintained, though these areas will lose their external windows. The adjacent walkways will be used as emergency circulation areas.
- The fluid distribution networks located on the structure of the present freeway can be maintained.
- The construction phase for the extension is simplified because the external shell of the

experimental hall will remain intact during much of the work; this provides a well-defined boundary for activities and will help to minimise operational disruption.

In addition, there are significant constraints related to the existing facility, as shown here:

- The extension of the Vercors area, and, more particularly, the extension of ID09, has an impact on the existing rooms S10-0-3 and S10-0-3a: A technical pumping room and access to the technical gallery linking the experimental hall to the main utilities and technical building. A suitable solution will be found to relocate these pumps and integrate access to the technical gallery.
- The relocation of the technical rooms where the large air handling units are currently located (air treatment of the experimental hall to control the air temperature).

3.2.3. Technical considerations and constraints

Access to works

Access to the common ESRF/ILL/EMBL site is controlled: A local contact notifies the site entrance

| Sector | Experimental area length (maximum distance between the source point and the final beamline lead wall) (m) | Constraints |
|---------------------------|--|--|
| ID01, ID31, ID32 | 140 | |
| ID02 | 115 | Length restricted by the multilayer laboratory building. |
| ID06, ID07, ID08, ID09 | 125 | ID07 is currently occupied by an RF cavity for storage ring operation. Its liberation depends on the solutions chosen within the X-ray source upgrade. |
| ID10 | 110 | Limited by the non-constructible zone along the A480 motorway. |
| ID20, ID21 | 110 | Limited by the Avenue des Martyrs and the Isère river and the road around the ring, which is required for access, safety and security issues. |
| ID22 | 105 | Idem ID20 and ID21, with the additional limitation of an access point to the existing experimental hall. |
| ID27, ID28, ID29 | 125 | |
| ID30 | To be studied | The limitation on the ID30 extension will be the final design of the other extensions created by the architects. An ID30 extension would lie in the critical zone between the existing experimental hall and the central building. |

Table 3.2.2: List of the sectors around the current experimental hall, experimental area lengths and constraints.

and authorises all visits. Visitors must give proof of identity in order to be provided with badges for the duration of their stay on site. Special procedures, yet to be defined, will need to be initiated for staff working on site in the context of the Upgrade Programme (for example, the creation of a dedicated entrance on the Avenue des Martyrs).

At present, the site has only one entrance situated at the southern tip. However, an additional, new entrance is planned. A project, running in parallel to the Upgrade Programme, aims to relocate the site entrance to the Avenue des Martyrs to alleviate road traffic bottlenecks at peak times. The proposals herein for external infrastructure to the buildings such as car parks, roads and underground networks are based on the assumption that the project for the new site entrance will have been completed.

• External access and circulation

The complete periphery of the experimental hall and its satellite buildings are currently accessible from the ground floor. A road closely follows the experimental hall's periphery, providing access to the building. It will be maintained after construction of the extensions, which will have access to their first floor, where necessary. The four extension areas will modify the road's path and some of the pathways to the building but, nonetheless, the following aspects will be preserved:

- No reduction in the number of existing access points from the experimental hall to the exterior.
- Maintenance of the exterior access doors permitting lorries to reach the area serviced by the six-ton overhead crane.

• Internal access and circulation

The existing experimental area is surrounded by a 3 m wide freeway situated under the load bearing structure of the hall. This freeway serves accessibility and security purposes and also defines the boundary of the beamline experimental area. A continuous ground level freeway will be maintained around the whole series of experimental halls, existing and future, to allow staff and materials unhindered access to both the current and extended beamlines.

In each of the extension areas, a circulation zone will be added at the first floor level, using the existing accesses to the offices. Together with these first floor circulation zones, a full 360 degree freeway would then exist, allowing easy and rapid circulation in the existing experimental hall and access, via staircases, to the freeways located between each beamline. It should be noted that the fluid chicanes enabling lorries to pass through the loading bays will be modified, thus guaranteeing the continuity of circulation around the existing hall.

Fluid networks

The site is equipped with all of the primary networks (rainwater drains, waste water, electricity, heating, cooling, telecommunications, etc.) required for the completion of this project.

The ESRF consumes a large amount of electricity (63 GWh/year) and is highly dependent upon the quality of the distributed current. There are two sources of 20 kV supply available on site at present, which will not be modified for the Upgrade Programme. They would, however, be complemented by a dedicated source for the high magnetic field facility (see section 2.4.5).

Authorisation for pumping water for cooling from the River Drac is 2500 m³/h and present consumption levels leave a surplus of some 700 m³/h at a maximum output temperature of 29°C. It should therefore be possible to use this surplus as a cold source for the extended areas of the experimental hall and other facilities, except for the high magnetic field facility, which requires much larger cooling power.

Stability of the extensions for the sample environment

Over the next few years, the spatial resolution of experiments on the ESRF beamlines will pass from the micrometre to the nanometre range. This improvement in terms of performance will have significant consequences on the sample environment. The extension design efforts will be concentrated on limiting the vibrations transmitted to the sample or associated support structures and designing an appropriate thermally stable environment. The construction of the ID11 and ID13 pilot projects for long beamlines was accompanied by detailed studies

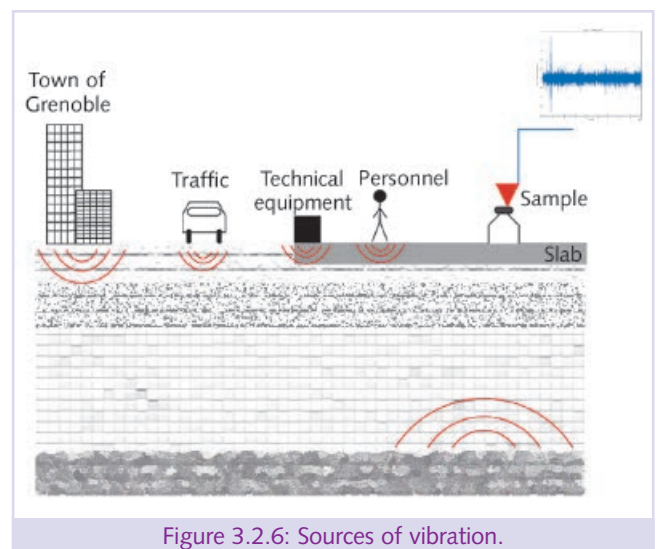

Figure 3.2.6: Sources of vibration.

on the dynamic behaviour of the ground and also on the thermal stability surrounding the samples. This knowledge, together with the actual operational experience from these two beamlines, will provide the foundations for the new design and engineering extension.

• Vibrational behaviour

Requirements on precision for synchrotron experimental installations are extremely high. Both the infrastructure and the various elements of the experimental stations will be designed to avoid any risk of disturbance, caused either by the dynamic environmental vibrations external to the ESRF site or by machines, staff and moving of equipment near to the measurement area (Figure 3.2.6).

In order to take into account the technical difficulties related to the construction work, a series of measurements will be made both in the framework of selecting the company for construction and throughout the duration of the project to be sure that all necessary precautions are taken.

The knowledge acquired during construction of the ID13 pilot long beamline will be used to achieve this. During feasibility studies, both the behaviour of the ground under the foundations, and the influence of pillars and of the floor thickness on the building's dynamic performance were investigated. The results were subsequently compared to the measurements taken *in situ* after work completion and validated the feasibility study methodology.

This methodology will be applied to the final choices proposed by the construction company to validate their solutions and, if necessary, to guide them in their approaches.

• Thermal behaviour

The extensions to the experimental hall must allow thermal stability, which is at least equivalent to that of the existing hall (within $\pm 0.5^\circ\text{C}$ for recirculation temperatures with a variable setting dependent on external temperatures). It should be noted that spatial stability is less important than temporal stability, particularly with short variations (less than 1 week). Long-term amplitude variations (over a week or longer) may be acceptable to adapt to seasonal fluctuations as these could be followed by beamline alignment.

The thermal environment in the experimental hall should enable the experimental hutches to achieve a thermal stability of about $\pm 0.1^\circ\text{C}$. This value was obtained with the refurbishment of beamline ID22 in 2006 and for the two new hutches on ID11 and ID13.

• Airborne dust in the experimental hall

The experimental halls created within the extensions

will not be constructed as clean rooms. However, since the extensions will house particularly sensitive and high-precision equipment, special attention will be paid to air treatment, to limit the introduction of dust, and also to the materials which will be used for the buildings.

Working conditions, working environment and ecological impact

The ESRF is a research institute financed by eighteen member countries and is a showcase for science and technology. At present, over five thousand visitors per year use the experimental setups for their research. The reliability of the technical infrastructures is therefore not only a critical factor in the success of an experiment, but the environment and working conditions also make a substantial contribution to satisfying users and making the ESRF's staff more effective.

The scientific activities of the ESRF are distributed around the existing experimental hall surrounding the storage ring. This causes access and circulation constraints, which will be solved by ensuring that access to the different sectors is as effortless as possible. The design of the working areas must be done in such a way as to make sure that the laboratories and offices are located around the scientific installations. Links between the different sectors (experimental area, existing buildings and satellite buildings) must be well thought out with the team of architects in order to maintain an effective working space.

The extensions will also optimise the number of buildings adapted for and accessible by disabled people (washrooms, meeting rooms, offices, laboratories, etc.).

The ESRF operates on a 24-hour basis which can mean difficult working hours for both users (experimental time slots) and for ESRF support staff. In addition to laboratories and offices, rest and relaxation areas and meeting rooms will also be included in the extension plans.

A high quality environmental approach to this project has been decided in order to incorporate legal requirements in relation to the comfort and quality of the working areas, constraints linked to the running of the existing site, the control of costs and maintenance processes for the operation of the facility and respect of the local urbanisation programme (*Plan locale d'urbanisme*, PLU, from *La Mairie de Grenoble*). The ESRF is working closely with an external specialist to put this into practice.

3.3. Computing Challenges

Science context

The new science that makes up the Upgrade Programme needs additional computing support and infrastructure. The ESRF computing will therefore be greatly enhanced so that the entire process of collecting vast quantities of data is more effective and efficient. This applies equally to instrument control, data interpretation, modelling, presentation, transfer and archiving as well as storage ring and beamline developments.

Today, scientific problems are tackled by a virtual army of specialists linked by computing hardware, software and transmitted data, which have become essential in allowing high quality science to be carried out. The Upgrade Programme will enable computing to help optimise the way science is undertaken at the ESRF and make the already essential role that computing plays even more pertinent.

The standard ESRF investment programme will allow computing to be maintained and slowly developed over the coming decade but will not allow it to keep pace with the increases foreseen in scientific demands and data throughput. The Upgrade Programme will allow the ESRF's computing facilities and resources to be enhanced via a necessary step function change which will directly benefit the quality of the scientific output and operation of the ESRF.

Added value of the Upgrade

The six themes of the Upgrade developments to the computing environment are summarised below:

- New and updated software linked together by a framework will allow data to be analysed whilst an experiment is running and provide feedback on the quality of the

samples and the experimental strategy in real time for a wide range of experiments.

- New off-line software will be developed to handle the simulations of nanofocusing ray-tracing and data interpretation and experiment protocols. Users will generally be able to export data analysis software to run on computers in their home institutes.
- By adopting data formats which conform to international standards, it will be possible to store metadata which contains all of the necessary information for automatic data analysis. Standards will also make collaborative efforts to develop data analysis, storage and dissemination more effective.
- A Grid environment will allow analytical algorithms to be run faster on a large number of processors and allow users to transfer data or results reliably to their home institute.
- New management information software will facilitate the management of scientific experiments and of a vastly increased quantity of data with the possibility of storing results in permanent archives that can be consulted via the web.
- A new data centre will allow increased data storage, processing power and network bandwidth to handle the increasing flow of data coming from the beamlines.

Partnerships

Many of the tasks above are relevant to all of the European synchrotrons and the goal of creating easy-to-use data analysis suites for each user community is too large to be carried out by just one institute. A European collaboration is therefore envisaged to work towards this objective and as a stepping stone to the eventual creation of a Virtual European Synchrotron Radiation Data Analysis Centre.

3.3.1. Introduction

This chapter focuses on the additional computing support and infrastructure that will be needed by the new scientific opportunities forthcoming from the Upgrade Programme. The main aims of the computing upgrade programme are to enable better science by providing rapid data analysis through the adaptation of existing or new data analysis programs and by making high-performance computer hardware readily available to all beamlines in optimal conditions. Addressing the problem of online data analysis together with an enhanced computing environment will be a major step towards improving the scientific productivity of the ESRF. The main impact of the Upgrade Programme will be to catalyse these essential developments by enabling peak load staff to be hired.

Grid technology will bring new ways of managing data and accessing computer processing power. The benefits will be immediate to the domains generating large quantities of data, such as tomography and macromolecular crystallography. Once back home, scientists can continue data processing over the Internet combining the computer resources of their laboratory with those of the ESRF. Virtual scientific communities, a powerful Grid concept, will foster international collaboration and greatly enhance the access to ample computer resources for the most computer intensive tasks.

Behind the scenes are the networks, computer clusters, storage and data back-up systems. Extra space will be needed to house these expanded systems. Therefore, a new computer room will be built within the Upgrade Programme to provide sufficient storage and cooling to cover the predicted requirements over the next 10 years.

This chapter also includes details of computing activities such as the development of the control system software and the Scientific Management Information System (SMIS). These projects will be pursued during the time covered by the Upgrade Programme but will be sourced to a large extent from the existing budgets.

Finally, much of the computing challenges posed by the science of the Upgrade are relevant across the European synchrotron light sources. The final section focuses on this and gives an example of a successful collaboration (DNA) that involves both light sources and academic partners.

3.3.2. Online data analysis

The experience of users at a beamline could be significantly enhanced by the addition or

improvement of online analysis programs that provide feedback on the quality of the data and a first look at results in real-time or quasi real-time. Data are being produced at a faster rate and in ever greater quantities. Data analysis, however, is not keeping step, leading to bottlenecks and increased latency.

The goal is to provide each beamline with a suite of online data analysis programs that can treat the experimental data in real-time. Staff are needed to port and adapt existing off-line data analysis packages to bring them online. Bringing analysis programs online means developing the necessary programming infrastructure for treating data as soon as possible after it has been collected on the beamline. Another essential part of data analysis programs is their user interface. New graphical user interfaces will be developed to simplify the setting up and running of these programs by non-specialists. The results will be visualised at the beamline using the best available data visualisation techniques, to make analysis easier and more intuitive. The programmers for each scientific discipline should be dedicated to this task for a period of at least 2 years. The disciplines to be addressed are single crystal diffraction, powder diffraction, macromolecular crystallography, spectroscopy, micro-diffraction and imaging.

Improving the scientific output at the ESRF over the next 10 years depends partly on the ability to solve the online data analysis problem. Online data analysis will be one of the critical high priority projects of the Update Programme. The principal data analysis issues are illustrated below with examples.

Online evaluation and visualisation

Most of the experiments carried out at ESRF beamlines already have a certain degree of online data visualisation utilities combined with generic online data analysis algorithms. The main objective of these tools is to give very early data quality estimations. The tools give feedback on the experiment in progress, help on deciding the continuation of the measurement and provide information to help decide on the subsequent stages to be performed and on the tuning of the parameters to obtain optimised data. The generic data analysis packages can also be useful off-line for searching through stored data, comparing different data sets and for basic data analysis. Wherever possible, these programs should also be available to users to run at their home laboratories.

Online data evaluation tools have to be fast and function in a manner that is non-disruptive to the experiment in progress. Non-expert users will find themselves confronted with the interfaces so the tools need to be generic and simple to use. Data visualisation for large and complex datasets

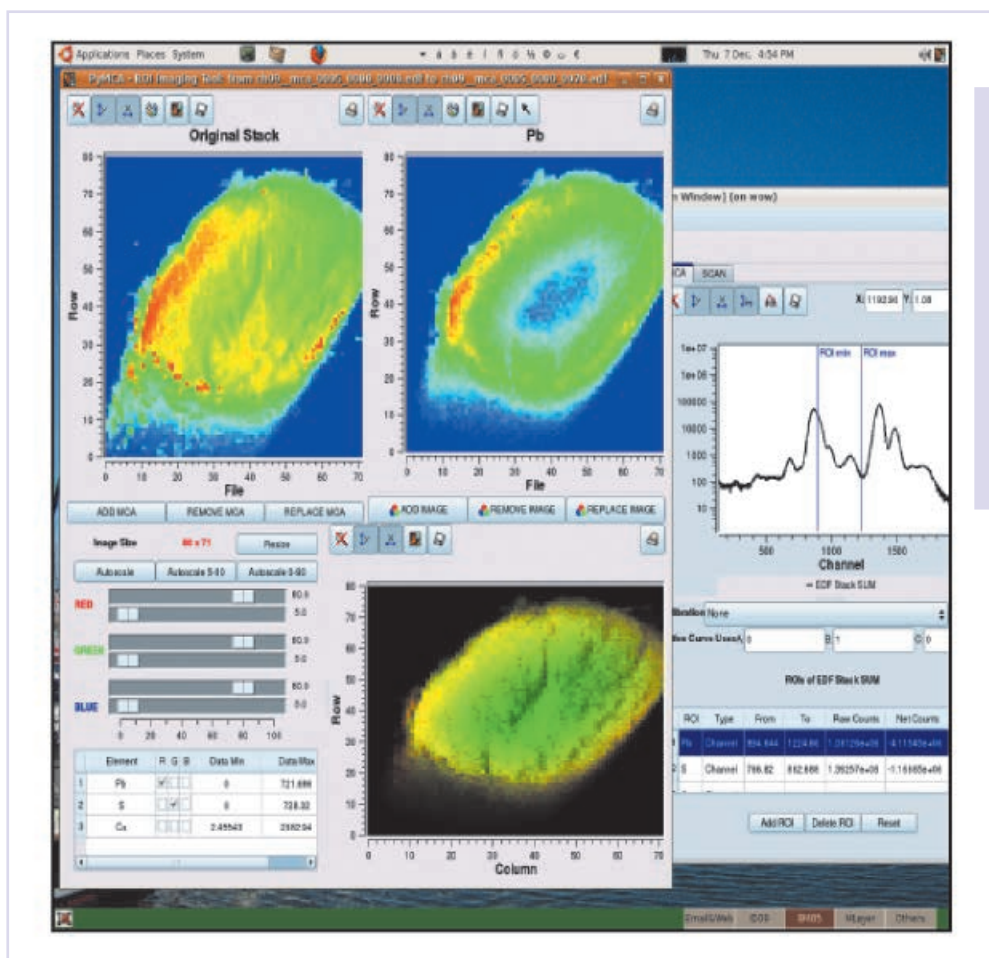

Figure 3.3.1: PyMca screenshot showing some of the visualisation techniques for fluorescence maps collected at beamline ID21.

PyMca includes powerful visualisation techniques for 1D to 3D data for spectroscopic data analysis. This tool is a reference in the field today and it is used at many ESRF beamlines and at other institutions such as SSRF, CHESS, LLNL, SOLEIL, PSI, ANKA and DIAMOND.

needs to explore innovative ways of presenting information and intuitive ways to represent and navigate through multi-dimensional datasets.

Tools will be developed for online evaluation and visualisation. Particular effort will be put into integrating analysis algorithms into these tools and exploring new visualisation approaches.

An illustrative example using an existing online data visualisation tool available at the ESRF (and elsewhere) is PyMCA (Figure 3.3.1), which provides peak search, different fitting algorithms, background subtraction methods, and energy calibration (Solé *et al.*, 2007). It supports batch processing of files in various formats and is able to process up to 5000 spectra per minute.

For 3D data exploration, a specific software toolkit needs to be selected and adapted to the ESRF's needs. There are a few existing packages that could be used as a starting point to the data visualisation needs of many crystallography and imaging beamlines (ImageJ, VTK/ParaView, OpenDX, VRML, etc.). The Upgrade Programme will allow us to explore the latest advancements in the 3D imaging domain.

Automated experiments and analysis

Scientific calculations on real-time data can be used as part of the experimental sequence for a number of different applications. The integration of the beamline instrumentation into experimental sequences described in chapter 2.1 can benefit in many cases from real-time data analysis calculations for building automated or semi-automated experiments.

The effort required in this field by the Upgrade Programme will consist of working on the integration of automated experiments for each project. Aspects to be treated will be performance, error handling, reporting, adapting of scientific code for parameter passing, etc.

Examples of data analysis in automated sequences include the use of wavefront analysis for automated mirror alignment or the use of image processing for assisted or unattended sample centring. This is illustrated by the cycle of the MX screening data collection pipeline (Beteva *et al.*, 2006). In this case, samples are automatically screened for their diffraction quality. In a recent experiment on the ID29 beamline, 250 samples were screened in a 13 hour period.

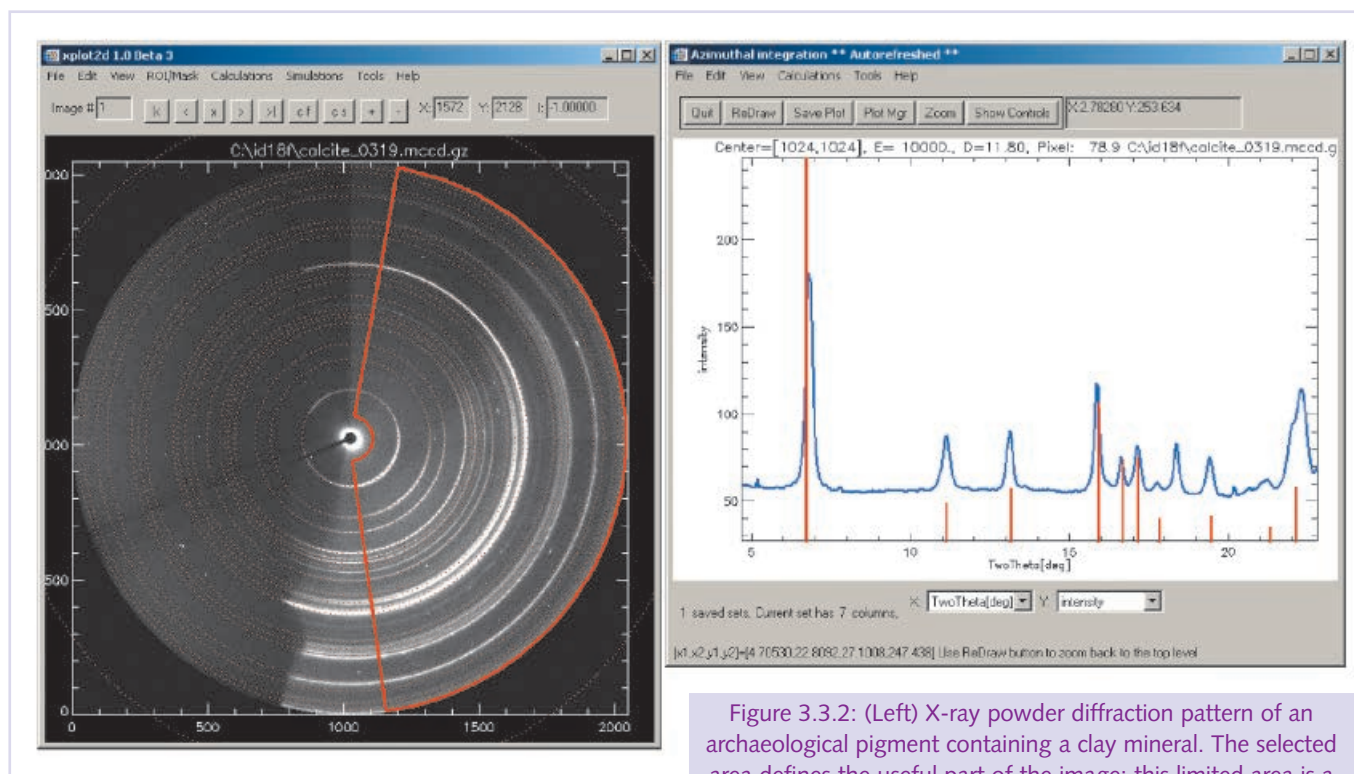

Figure 3.3.2: (Left) X-ray powder diffraction pattern of an archaeological pigment containing a clay mineral. The selected area defines the useful part of the image; this limited area is a consequence of making the measurement in grazing incidence geometry. (Right) The diffraction pattern obtained by azimuthal integration of the selection in the left image. The pigment contains a main phase of palygorskite, as shown from the comparison with a reference compound (Unpublished data).

ESRF users' report:

http://ftp.esrf.fr/pub/UserReports/28638_A.pdf.

High-throughput online data analysis

The time taken to perform extensive data manipulation, such as large volume computer tomography (CT) reconstructions, has dramatically decreased in the last decade such that volumes of several gigabytes can be reconstructed in only a few minutes. This became possible with the advent of faster computers and, in several cases, computer clusters, using software for parallel processing.

Two examples follow, which show some of the online data tools currently being used at the ESRF. These tools have the potential and requirement for substantial performance improvements to keep pace with the ever increasing read-out speed of 2D detectors and to make them suitable for automated batch processing.

- XAS online tools: Many beamlines, and in particular the imaging beamlines, can record maps over samples where every image point represents a spectrum. The massive yield of these XAS data has created the need for analysis software capable of processing hundreds or even thousands of spectra in one scan and performing the classical data reduction operations (background subtraction, spline fitting, normalisation, Fourier analysis). The software available at the ESRF, the XAID extension of XOP (<http://www.esrf.eu/computing/scientific/xop2.1/>), carries out this essential pre-processing. Its elaboration to include full mapping capabilities is one of the forthcoming programming challenges during the time span of the Upgrade Programme.

- X-ray powder diffraction online tools: X-ray micro- or even nanobeams permit numerous tiny areas within a sample to be examined in detail. In particular, for powder diffraction, a large number of diffraction images can be acquired for one sample. This has opened new possibilities for identifying crystalline compounds in scientific areas such as environmental science and cultural heritage. Although many programmes are available at the ESRF for image display, correction and azimuthal integration, none is really able to identify the crystalline phases during the analysis of the images. Therefore, an analysis system will be created that compares acquired data with reference data either calculated or stored in a user-defined and extensible library. An example of a program for powder diffraction image display is shown in Figure 3.3.2. This kind of analysis is generally coupled with XRF elemental analysis on multipurpose beamlines to extract chemical and crystallographic information from the sample.

Some of the analysis programs which will require resources to be developed further in the future to the levels required for online analysis, especially given expected improvements in instruments and detectors, are:

- Quantitative XRF analysis by fast Monte Carlo methods (CDR: XMAN)
- Total Crystallography (TotalCryst, <http://www.totalcryst.dk/>) and the XRD Nanoscope of beamline ID11
- Fast SAXS data analysis (shape reconstruction) of proteins in solution (CDR: HISAXS)
- XANES micro-mapping combined with iterative transformation factor analysis (CDRs: XAS-XES, EDXAS-L/EDXAS-S)
- Automated collection and processing of X-ray protein crystallography data (CDRs: MASSIF, MX-MAD1 and MX-MICROFOCUS)
- Enhancement of SAXS data processing programs for time-resolved measurements (CDR: SAXS)

Online data analysis software framework

The development of online data analysis for complex scientific problems will benefit from a framework allowing new modules to be reused across domains, and even among European Light Source Facilities. The framework will allow a large number of data analysis software modules to be plugged in and executed. It will provide users with a common platform for running a wide range of programs, and create a container for data analysis codes developed by the various groups at the ESRF and their external collaborators. A framework will also facilitate the implementation of high throughput online data analysis and provide facilities in key areas such as workflow, sequential analyses, data management and data processing.

An example of an existing software framework is FABLE, used in the domain of polycrystalline data analysis. FABLE is part of TotalCryst (www.totalcryst.dk), which is a European project to apply single crystal techniques to polycrystalline samples to improve the quality of the results (Vaughan *et al.*, 2004). Orientation matrices for individual crystallites are determined simultaneously and then integrated, filtered and summed to arrive at a single-crystal-like data set. This technique is especially promising for a large class of samples which are neither good powders nor good single crystals. All of the elements of the problems facing online data analysis have to be tackled for this project. The result will be a software framework for treating polycrystalline data. The Upgrade Programme can benefit from the work done on this project by extending it and applying the resulting framework to other scientific areas which need complex online data analysis programmes.

Requirements identified in the CDRs

Based on the CDRs, the following data analysis requirements have been identified:

- Online tomography reconstruction – initially in the form of simple (one slice) sinogram reconstruction produced online. As the time needed for a complete reconstruction will shrink, the possibility of producing/visualising the whole dataset in real time will become possible (CDRs: IMPACT, MX-BIB, CPR, SFINX).
- Multidimensional visualisation – handling large quantities of spectra, images or multidimensional data in an intuitive way (CDRs: SFINX, SURF, TRS, TRD, CDI, EDXAS-L, EDXAS-S, XMAN, IMPACT, MAGSCAT, MATSCI, MASSIF, MX-MAD-1 and -2, GISD).
- Data reduction – to extract information from acquired data in real time (CDRs: PMF, SURF, TRD, XPCS, EDXAS-S, GISD, HISAXS, INELX, MAGSCAT, MATSCI, MINADIF, MASSIF, MX-MAD1 and -2).
- Computer vision – the use of computing image analysis algorithms as help during experiments mainly for sample handling such as alignment, identification, multi-spot data collection, and damage identification (CDRs: TRD, XMAN, EDXAS-S, CPR, GISD, IMPACT, MAGSCAT, MINADIF, MX-BIB, MASSIF, MX-MAD1 and -2).
- Adaptation of specific algorithms for online analysis and simulation – the development of modules to connect specific algorithms to the online data visualisation (CDRs: SAXS, XPCS, EDXAS-S, TRD, XPCS, MINADIF).
- Pipeline mode – multi-sample data collection with data analysis as part of the collection sequence (CDRs: MASSIF, MX-MAD1 and -2).
- 2D data analysis – availability in real time of 2D data analysis algorithms (CDRs: SFINX, OPTICS, PMF, SAXS, TRS, XPCS, CDI, HISAXS, GISD, MAGSCAT, MINADIF, SURF).

3.3.3. Software for scientific computing and off-line data analysis

Faster and more thorough data analysis and interpretation are needed to keep pace with the advancing science. This sets new goals for the scientific computing area at the ESRF. The case for faster online data analysis has already been stated. Here, the more intensive computational tasks which tend to become increasingly complex are considered. Single CPU performance is not expected to increase by much, making stand-alone workstations seem less attractive for scientific computing. The increasing

complexity of the calculations can be offset by exploiting both parallel and distributed computing.

One challenge is the increased complexity in the simulation of nanofocus beamlines and computer assisted focusing systems. Owing to the envisaged upgrade of the ESRF synchrotron source and nanofocusing beamline requirements, it is important to keep pace with the rapid evolution of X-ray optics and the related computational tools to simulate complex beamlines with high precision optics. Assisted focusing and longer time-span corrections will rely on the accurate return of beam position data to the focusing algorithms and development of automatic focusing is needed with the implementation of a feedback system to maintain a beam position in real time.

The second challenge arises from the complexity of algorithms currently used off-line (off-line by necessity because of their long run time) for experimental data analysis and interpretation. Typical examples of off-line algorithms that cannot be run during experiments are Monte Carlo, *ab initio* calculations and molecular dynamics. Soft condensed matter, X-ray absorption and magnetic scattering as well as high resolution and resonance scattering are areas that will benefit from these kinds of improved modelling tools permitting the beamlines to remain at the cutting edge of X-ray science worldwide. Programs used in these areas at the ESRF for complex

off-line analysis and simulations are often written by authors away from the ESRF site. To catalyse the conversion of code for parallel or distributed systems, the ESRF will need to coordinate the work with the off-site authors and quite likely use its own peak load staff to aid the process. Once converted, some programs may then be usefully incorporated into the online analysis framework described in section 3.3.2. The parallelised code will be of benefit beyond the realm of the ESRF beamlines and will be made available to the broad community. These areas are described in more detail below and a number of specific examples are given.

Software for ray tracing and focusing systems

With the refurbishment and construction of new beamlines, there will be a need for a more flexible ray tracing tool capable of meeting the forthcoming nanofocusing challenges. The development of new numerical modules based on advanced wave-optical approaches is also required, as well as multiple crystal X-ray dynamic theory calculations.

Calculations for the design and optimisation of X-ray optics are usually quite time consuming, and require specialised software. A substantial effort has already been invested at the ESRF in developing optics tools and facilitating their use. The XOP package (<http://www.esrf.eu/computing/scientific/xop2.1/>) was

created with the aim of performing quick calculations and simulations of X-ray sources and optical elements, whereas the interface ShadowVUI (an XOP extension) was designed to perform Monte Carlo ray tracing calculations. A substantial effort will be needed to upgrade and eventually redesign and enhance the existing applications by basing them on a modern software architecture and by the incorporation of methods to better describe optical surfaces in terms of surface irregularities. This is a necessity for future nanofocusing beamlines. A substantial effort is needed in terms of the design and coding of new applications, using

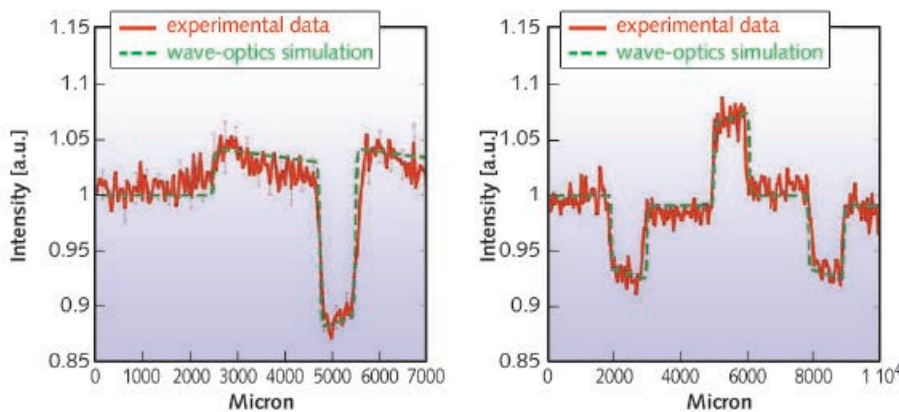

Figure 3.3.3: The physical behaviour of a setup for analyser-based imaging following a wave-optical approach can already be simulated today (Bravin *et al.*, 2007). Such a setup consists of a monochromator crystal, a sample, and an analyser crystal in Bragg geometry placed downstream from the sample. In particular, the above image displays: (a) the intensity pattern (a.u.) of a triangular Plexiglas wedge imaged using a taper optics CCD camera and Si(111) reflections located at $L = 2.2$ m distance from the sample. The experimental (red) and the theoretical curve (dashed green) are in excellent agreement; (b) the intensity pattern (a.u.) of a trapezoidal wedge of the same material under identical experimental conditions. Again, the experimental (red) and wave-optical curve (dashed green) match each other very well. In the future, with the Upgrade, we envisage the generation of wave-optical models for a wider class of optical elements in order to be able to predict in a comprehensive way the optical behaviour of an entire beamline, possibly taking into account manufacturing imperfections of the optical devices.

for example a unique mathematical class of curves/surfaces to describe all optical surfaces and a new ray-tracing kernel.

The removal of beamline optics effects (instrumental functions) to discriminate between artefacts introduced by the optics and the real signal from the sample is an important requirement for data analysis. Deconvoluting inelastic scattering spectra by using advanced Monte Carlo ray tracing techniques is just one example of the forthcoming challenges. Furthermore, there are increasing requests for wave optics tools (Bravin *et al.*, 2007; Peterzol *et al.*, 2007) capable of correctly simulating phase contrast images without the weak object approximation, as well as characterising quantitatively nanofocusing optical elements such as CRLs, elliptical multilayers, and curved crystals. Once developed, wave-optical approaches that take into account coherence effects and penetration in samples will eventually supersede the current algorithms.

Figure 3.3.3 illustrates the potential of a wave-optical approach to the simulation of analyser-based imaging.

Other optics software requirements are for computer assisted beam focusing and beam position monitoring. Software for beam focusing via KB and/or toroidal mirrors is currently in great demand at the ESRF. The advent of the nano-era will pose even greater challenges. A new generation of customisable real-time software must be developed from the current software and adapted to the ESRF nanofocusing elliptical multilayers and similar optical devices.

2D diffraction data analysis and reduction

The continuous evolution of diffraction beamlines drives the further development of area detector data analysis software. In particular, customisable modules for the integration of small molecule single crystals and powder diffraction data at large two-theta angles are required for the unique needs of the ESRF beamlines such as high-pressure specificities of twinned and multi-crystals or varying shadowing from diamond-anvil cells. This software also needs to be compatible with a variety of detectors.

The ESRF program FIT2D

(www.esrf.eu/computing/scientific/FIT2D/) has been adopted by many laboratories around the world. This wide user community has requested an overhaul of the user interface and that new features be added. FIT2D was designed essentially for a detector placed orthogonally to the incident beam with small misalignments. FIT2D needs to be extended to two-theta = 90 degrees and ported to modern software architecture. Figure 3.3.4 presents a 2D view from FIT2D as an example of the functionality currently available.

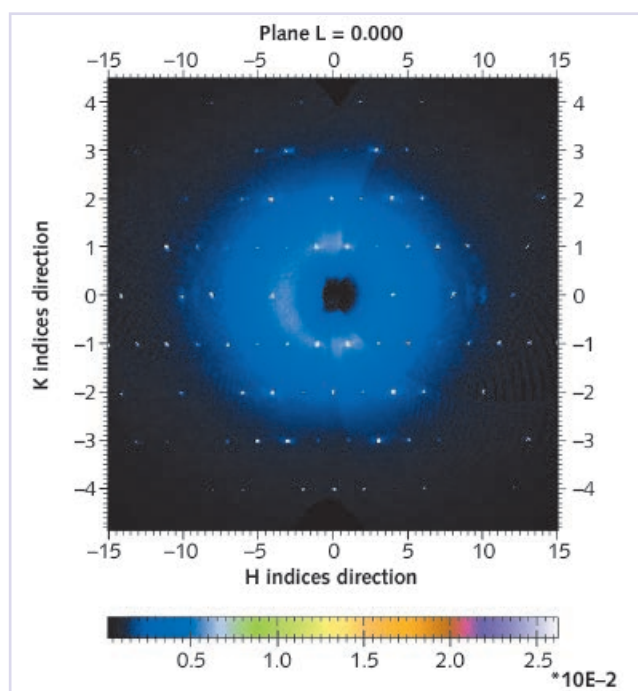
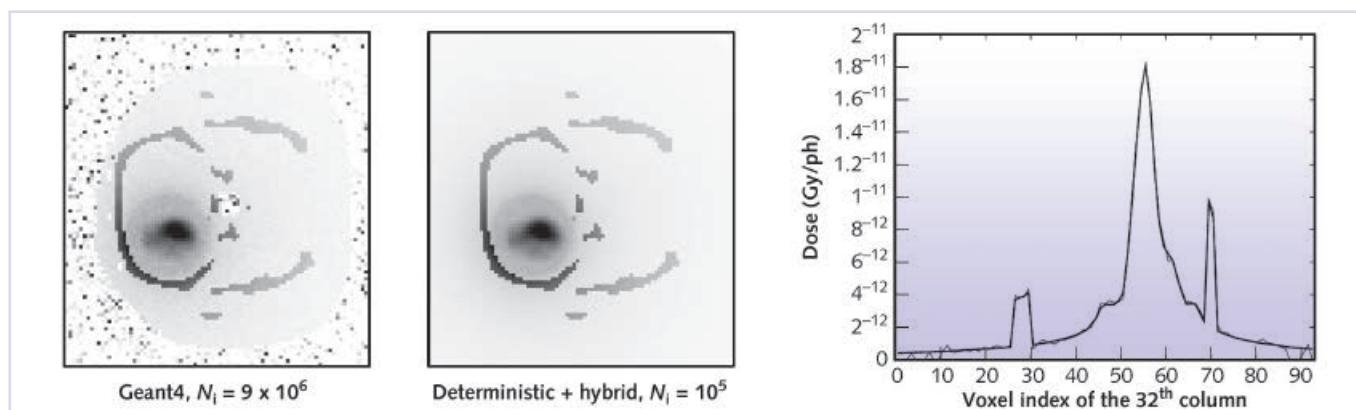

Figure 3.3.4: This diagram shows one slice out of a 3D volume of the reconstructed reciprocal space of an InGaAs single crystal. In the near future with advances in computer hardware, particularly the availability of low cost huge physical memories (RAM) and fast processors, the reconstruction of large volumes of reciprocal space can be made online in real time, and sophisticated 3D viewers will be used to visualise, investigate, and manipulate the 3D data. Reciprocal space mapping is frequently used to study and determine the structural properties of thin epitaxial films such as composition, layer tilt, lattice relaxation and structural quality. 3D mapping in reciprocal space using area detectors opens up new possibilities in structural characterisation of nanomaterials based on recording of 3D maps in the vicinity of selected reciprocal lattice points.

Absorption spectroscopy and anomalous scattering

There are at present two approaches for simulating the electronic structure of complex materials. These two approximations give complementary information: multiplet codes work well for localised properties whereas band structure codes work well for delocalised properties (Mirone *et al.*, 2006). In real-world examples, the reality lies somewhere between, and an approach is needed to merge these methods. An example of where this will be used is in spectroscopy, such as absorption, RXS and RIXS. An ambitious Upgrade task, therefore, is to integrate the existing *ab initio* electronic band and multiplet calculations in collaboration with experts in this domain. The software currently used to simulate X-ray absorption, near edge X-ray absorption and resonant X-ray scattering is FDMNES. Until the ultimate electronic structure code is available, FDMNES will be supported and extended.



Courtesy of N. Freud, CNDRI, INSA-Lyon

Figure 3.3.5: Simulation of dose deposited by direct radiation in a slice of the rat head (Freud *et al.*, 2007). The Monte Carlo simulation was carried out with 9.006×10^6 incident photons (left image). Deterministic results (right image) are free of noise. The profiles, corresponding to the 32nd column of the two images, are presented in terms of deposited dose per incident photon (Gy/ph). The Upgrade will allow these calculations to be made more rapidly allowing experiments to be modified and human treatment plans to be optimised.

Another Upgrade target is extending EXAFS data analysis with wavelets. The analysis of EXAFS data, although standard at present, nonetheless leaves room for new developments and improvement. As an example, wavelet transforms have proven to be a valuable tool for EXAFS data analysis, especially for discriminating two types of atoms sitting at the same distance from the photo absorber. The development of a fit procedure based on the continuous wavelet transform would represent a substantial complement of the existing EXAFS data evaluation techniques.

X-ray magnetic scattering

X-ray magnetic scattering (XRMS) can be used to determine both spatial distribution and orientation of magnetisation (Mirone *et al.*, 2007). To relate the experimental data to these multipole moments and optimise the data collection strategy, numerical and analytical algorithms need to be developed at the ESRF.

Ab initio computation

Ab initio computation requires extra human resources to greatly enhance the service provided for our scientific community. The external software supported at the ESRF for the areas of quantum chemistry, *ab initio*, quantum mechanics, and molecular dynamics, DFT, non-muffin tin, atomic and cluster-wise multiplet, are ADF, GAMESS-UK, StoBe, VASP, Wien2K, ABINIT, Siesta, Gaussian03, GROMACS, Moldy, MXAN and MISSING. Maintenance and parallelisation of these programs and the writing of link modules between some of them represent important activities at the ESRF.

An example is the use of Monte Carlo calculations for synchrotron radiotherapy. SSRT and MRT require a great effort in terms of reliable and fast dose

deposition calculations. Predictions from several algorithms must be compared and assessed. In the human treatment protocol, the operator must be able to quickly change the irradiation conditions according to the deposited dose. A hybrid simulation combining Monte Carlo and deterministic algorithms (Figure 3.3.5) is needed that runs in parallel on a dedicated computer cluster. Several utilities will also have to be provided to optimise the treatment plan. The SSRT and MRT treatment problem can be roughly formulated as follows:

A target is irradiated (normally a cerebral tumour) with an X-ray beam of known (but not fixed) characteristics (size, energy spectrum, photon flux, in-depth energy deposition). The target can be moved either by rotation or translation. To obtain the dose (energy per unit volume) to be deposited on the target itself, one must know the optimum combination of the physical and geometrical parameters which spares the tissue surrounding the tumour and prevents the beam from passing through vulnerable parts like eyes while ensuring the desired dose deposition.

There is no software readily available for this problem, and designing such code is a considerable task, taking into consideration the complexity and the mandatory reliability for the treatment of human cases (see CDR: CPR).

Requirements identified in the CDRs:

- *Ab initio* computations: CPR, APS, XAS-XES
- Software for ray tracing and focusing systems: OPTICS
- 2D diffraction data analysis and reduction: TRD, SURF, HIPRE
- Absorption spectroscopy and anomalous scattering: INELX, EXAFS, EDXAS-L/EDXAS-S, RIXS-PES
- X-ray magnetic scattering: MAGSCAT, SMS

3.3.4. Scientific data handling and curation

The effective management of data is central to the scientific process. In many cases, the experiments carried out at the ESRF are only one step in this process, complemented by other experiments in other facilities. A uniform approach to data handling would allow results to be compared seamlessly between different scientific domains and facilities without concern for the underlying software infrastructure.

Data curation

Data curation is the task of storing valuable data in the very long term so that it can be reanalysed at a later date with improved analysis procedures. This is necessary to verify results, to rerun analysis programs with different parameters, to allow a larger scientific community access to the data, or to permit easy long-term access for international collaborations.

Currently, the ESRF does not have a system to facilitate data curation and is only able to offer short-term data storage (for a typical duration of 6 months), after which the data are deleted locally. Legal constraints may indeed make data curation an obligation in the future.

Data curation will require increased disk- and tape-based storage capacity and a permanent archive of metadata. It is expected that curated data could represent up to one-third of the total data produced at the ESRF. Implementation of the metadata archive is necessary from scratch. It is planned to do this with the help of standard data formats such as Nexus, database technology and web-based browser software. International collaborations will be developed to share expertise, solutions and create common databases with other synchrotrons and even neutron sources. Grid software will help to access the data repositories within virtual organisations (see also [section 3.3.7](#)). Curated data will need to be displayed easily and rapidly. Therefore web-based data visualisation will also become an important issue.

Data file formats: The need for an international standard

At the present time, the in-house formats for data storage and transfer at the ESRF are SPEC and ESRF data format (EDF) files. Although data from these files can be extracted and copied to other formats and many data access libraries are available, many users find it difficult to access data and navigate efficiently throughout the large amounts of data that they record during their experiments.

We will switch to Nexus (<http://www.nexusformat.org>), and ImageCIF as a subset of Nexus, as a standard data format for the ESRF. Nexus is well established and widespread in other synchrotron and neutron facilities. It will allow the storage of different data sets (1D, 2D and 3D) in a common format along with the experimental parameters. Switching to Nexus will pave the road for long-term data archiving because all experimental parameters can be properly stored with the data. It will also allow data analysis programs to analyse data and compare results from different types of experiments done in different laboratories. Considerable work remains to be done for the definition of the metadata tags for all of the different types of experiments at synchrotron light sources. We expect the adoption of Nexus to lead to a common database, set up in collaboration with other institutes, allowing review committees and scientists to quickly find out which measurements have been made for a particular sample in the past. An attempt to achieve this is already in preparation together with ISIS, Diamond, and the ILL and will lead to an FP7 proposal.

3.3.5. Accelerator and beamline control system

The control system will play a major role for the improvements planned as part of the Upgrade Programme for the accelerator and beamlines. For the accelerator, the control system will be crucial in achieving the enhanced beam performance of the upgraded ESRF accelerator complex. For the beamlines, the control system will have an increasing number of devices to control. Reliability, reproducibility, and user-friendliness will guide the envisaged software developments.

TANGO

The ESRF's control system, TANGO (<http://www.tango-controls.org/>), is a modern control system that originated at the ESRF in 1997. It is now used at three other synchrotrons: SOLEIL, ELETTRA, and ALBA and is being actively developed by a collaboration consisting of all four institutes. A fifth institute (Petra III) is planning on joining too. This fruitful collaboration has allowed the workload of developing the TANGO core as well as a number of additional software components to be shared. The objective is to increase the level of software sharing to enhance the quality and performance of the system as a whole whilst keeping it state of the art. TANGO is theoretically capable of controlling even larger accelerator complexes and providing more software services for doing beamline experiments.

Beamlines have recently been upgraded to be TANGO compliant. It is envisaged that, in the future, all new device servers for beamlines will be written as TANGO device servers. As part of the Upgrade Programme, it is planned to add new beamline specific features to TANGO.

RF and injection subsystems

The upgrade of the complex RF transmitters (enabling reliable 300 mA operation) and the injector system (enabling topping up) will necessitate a considerable effort in software development. The Accelerator and Source Division projects upgrades to the RF transmitters to solid state amplifiers, which are currently being used at SOLEIL. Consequently, the associated software will have to be rewritten. The experience gained by SOLEIL will be put to good use. Nonetheless, many servers and the graphical user interface will have to be written to adapt the ESRF RF architecture. The replacement of the existing cavities with HOM free cavities will also need extensive software development. With the introduction of topping-up injection, the injection procedure will need to be renewed and diagnostics and feedback loops added to the injector system. The Booster Power Supply System will also be rewritten.

Diagnostic tools and graphical interface

New beam diagnostic tools with fast feedback loops and powerful data-logging systems will significantly increase the beam stability and allow rapid analysis of the event in the case of a beam loss incident. New control system software will further reduce downtime from the already low levels of today by helping the accelerator physicist understand the subsystems and in the understanding of physical events. To achieve this, the display of parameters and navigation from subsystems to displays of signals from individual equipment will be redesigned to make them more intuitive and user-friendly. The user interface needs to be re-designed to present a concise overview of the accelerators. This means replacing many of today's individual graphical user interfaces by a unique graphical environment from which equipment and diagnostic tools for feedback loops can be accessed. The basis for this work will be a toolkit of graphical components, which can be re-used and assembled at will by the accelerator physicists, operators or programmers. The generalisation of round-robin buffering of equipment signals will ease post-mortem analysis and playback of events. In addition, web access to archived signals will allow the analysis of slow phenomena such as drifts and ultimately data mining the archive will help in the planning of preventive maintenance. Staff will also be able to monitor equipment

remotely by connecting to the accelerator control system via a secure web interface. A level of security will be built into the system to track any attempted malicious action.

A particular example showing the evolution of the control system is the adoption of embedded controllers. In the near future, embedded controllers will exist in all parts of the machine control system. This will allow unprecedented signal processing capabilities. The controllers connect to the Ethernet (wired or wireless) and they run as device servers. This reduces specific cabling costs, and the cost associated with the writing and maintenance of dedicated software. However, the envisaged high number of controllers will inevitably pose new challenges for the deployment and maintenance of such systems, each running the Linux operating system and the TANGO control system. The ESRF control system, TANGO, was specifically designed to be compatible with intelligent controllers. However, we will need to ensure that TANGO scales with the increased number of controllers without degrading the performance of the system.

3.3.6. Scientific management information system

The scientific management information system (SMIS) handles various aspects of a scientific experiment at the ESRF. These range from the management of the scientific proposal, to scheduling of the experiments, safety considerations, tracing of samples (currently only for macromolecular crystallography), registration of the experiment reports, access to publications, and even the travel and accommodation of the visiting scientists. Two other laboratories, ANKA and Diamond, have adopted the SMIS system for their proposal workflow. Diamond and ESRF are already collaborating to re-write parts of the system to base the oldest modules on modern software technology and to restructure the system.

With the experience gained by running this complex software over the last decade, the following points justify a substantial overhaul and extension of the system:

- The workflow complexity is rapidly increasing, and it is becoming difficult to program for individual exceptions and setups. In addition, experience from other software projects at ESRF has shown that configurable software can cover a much larger span of functionality. It is therefore intended to add a configuration layer to the SMIS and render the underlying applications more generic, thus allowing users to adapt the software to different usage patterns.

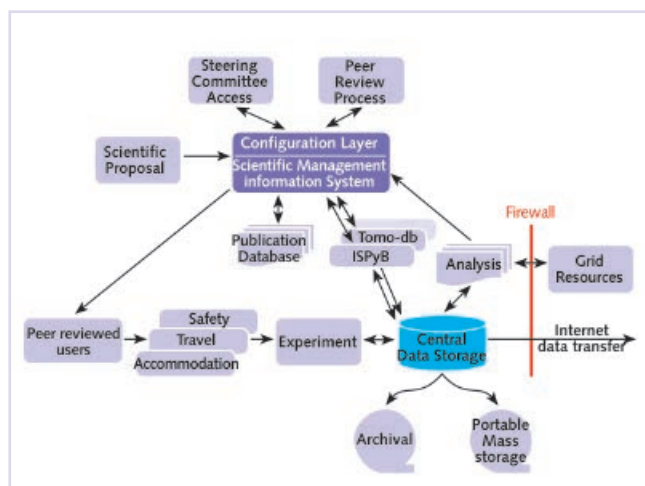

Figure 3.3.6: A block diagram showing the future extended and restructured SMIS at the heart of the scientific data cycle.

The management system embraces the entire scientific workflow from user proposal and review to experiment, data back-up, archiving and transfer back home to user reporting and publication.

- Experience gathered with the ISPyB plug-in has demonstrated the power of following all aspects of the experiment from the proposal to the publication. This development was particularly important for dealing with the large number of samples in macromolecular crystallography, but many other domains at ESRF would also benefit from similar functionality, for instance tomography experiments for which an independent database already exists. Additional links to metadata capture and data analysis would greatly enhance productivity and follow-up of the experiments.
- The updated SMIS must be based on open source software tools and components for standards compliance to guarantee long-term maintainability of the system.

The joint development with Diamond for the extended SMIS will be continued (Figure 3.3.6). Other national light sources will be encouraged to join this initiative with the possibility to create a common European synchrotron user database.

3.3.7. eScience and Grid

Grid computing is an advanced form of distributed computing. Grid software is used to manage computing hardware such as computer clusters, storage and network resources. The goal of the Grid is to create an illusion of a simple yet powerful self-managing virtual computer out of a collection of connected heterogeneous resources. The Grid offers advantages such as enabling programs to run faster by giving them access to more resources, more efficient management of resources, a better security model,

and more economical investments in computing resources. Grid computing opens up the possibility to share those resources over administrative domains. These features make the Grid infrastructure ideal for any scientific research especially where the time and resources needed for running the applications are considered impractical when using traditional IT infrastructures. Having such resources available may change the way scientific research takes place. To achieve these goals, we need to install and configure Grid software that runs on top of our computing infrastructure. The Upgrade Programme will allow peak load staff to be hired to do this work. It is also foreseen to hire one technician on a permanent basis to manage the Grid software and hardware in the future.

Although our primary intention is to find new ways of interacting with very large data sets generated by the upgraded ESRF, the efficient use of Grid software entails the creation of user communities across Europe. During the time span of the Upgrade Programme, it is expected that all new third-generation synchrotron radiation sources will be using compatible Grid software for accessing and managing the computing resources in a transparent, yet accountable, manner. The ESRF has a major role to play in assisting and possibly even coordinating these efforts on a European scale.

The first large-scale Grid infrastructure, the Large-Hadron-Collider Computing Grid (LCG), aimed to build and maintain the data storage and analysis infrastructure for the high-energy physics community that will use the Large Hadron Collider. In Europe, the Enabling Grids for E-science project (EGEE, <http://www.eu-egee.org/>) evolved out of the LCG project and has become the world's largest Grid infrastructure in production. To prepare the future for the ESRF and its user community, a strong commitment to the Grid technologies will be made, taking advantage of the huge development efforts of the LCG and EGEE projects. Whether it makes sense to create Virtual Organisations (VO) for our scientific communities under the umbrella of the EGEE will be studied.

Below are listed the Grid resources and components that the ESRF will make use of:

- **Computational resources:** Computer clusters made from commodity computers are today's best solution to high-performance batch computing. We have started to concentrate our onsite computer power in several interconnected clusters connected to the NICE storage facility and managed by Condor. This system has proven to be reliable and offers high performance. It will be upgraded to add functions such as checkpoint/restart and a better separation between interactive and batch processing. By adding a Grid software layer that will use Condor as a local

workload manager, authenticated and authorised access to this resource for local (Intranet) as well as remote (Internet) users will be made possible to share or aggregate the computational resources with other laboratories.

- **Storage resources:** New ways will need to be found of interacting with expected very large data sets generated by the new science coming from the Upgrade Programme. Grid software can leverage data analysis and curation of these large data sets. It will open the possibility to give secure access from remote sites to these data, to analyse them with computer resources made available at the ESRF and to transfer raw or analysed data reliably to Grid resources at user's home institutions.

- **Network resources and virtual organisation membership services:** A high-performance and reliable networking infrastructure is fundamental for leveraging optimal usage of Grid software. Grid services for reliable data transfers, data replication and data curation as well as data treatment will give ESRF users the possibility to continue their scientific work from their home institutions in a secure and controlled manner. Virtual organisations grouping scientists working in the same field can be configured to give secure access to computer and storage resources, which are either centralised at ESRF or shared between participating parties inside the same virtual organisation. During the time span of the Upgrade Programme, we expect that all third-generation synchrotron radiation sources will be implementing or using Grid-compatible software for accessing and managing computing resources attributed to VOs in several research areas such as protein crystallography, life sciences, and X-ray imaging.

- **Code repositories:** Scientific software needs continuous upgrading and maintenance. Code repositories in a Grid environment can improve the use and reduce the maintenance efforts for such software. It also gives the possibility to establish Computing On Demand (COD) in VOs, reducing the need for time consuming data transfers. It is our intention to pioneer a code repository available through Grid services to all our users and other synchrotron radiation facilities in Europe.

- **Catalogues:** In some scientific areas, databases of metadata and publications (catalogues) linked to measurements and their data made at the ESRF or other synchrotron radiation facilities will allow queries or browsing of scientific results for judging, comparing, or complementing new data sets. The basis for such catalogues is a common data format containing not only the raw data but also processed data and metadata attached to a data set. It is our intention to foster the usage of a suitable common data format and to carry out research and development on data catalogues and their Grid services for browsing and retrieval.

- **Grid security infrastructure:** The connectivity layer in Grid software defines core communication

and authentication protocols required for the Grid Security Infrastructure (GSI). Authentication and authorisation protocols build on communication services to provide cryptographically secure mechanisms for verifying the identity of users and resources. The features available today make it possible to define VOs that span geographically distributed organisations with different administrations. The same functionality can be used to provide secure services to individual users or user groups. It is our intention to migrate from our current password-based security system to a certificate-based security system for all our internal services that will be compatible with EGEE grids for Grid services visible externally.

3.3.8. Computing infrastructure

The importance of computing is set to grow dramatically across almost all scientific fields. Computing has changed how science is done, enabling new scientific advances by making new kinds of experiments possible. These experiments are also generating new kinds of data that are increasing exponentially in their complexity and volume. Achieving the goal of being able to use, exploit and share these data most effectively is a huge challenge.

The trend we see in almost all aspects of computing is exponential growth in bandwidth but sub-linear growth in latency. For example, storage capacity, memory capacity and network bandwidth are increasing dramatically but the rate of data processing (determined by variables such as disk access and processor speed) is only increasing by a much slower relative rate. This generalisation even applies to commodity machines which will probably not get much faster, but they will gain the parallel computing power and storage capacity that used to be limited to expensive specialised hardware.

There are challenges within the scope of an individual processing cluster. Many clusters built over the last decade were I/O poor. In order to be able to perform data intensive computations successfully, we need systems with adequate I/O bandwidth to deliver the data to the CPUs. Single processors with uniform memory systems and hierarchies are being replaced by non-uniform multi-processor ('multi-core') systems. Scaling already challenged by huge datasets is now also challenged by much more complex computing platforms, previously only known to supercomputing. The challenge is multiplied by the need to integrate across the Internet.

Another major issue is the distribution of data. Database technology has recognised for a long time that it is expensive or impossible to move large

quantities of data. Instead one moves the code (software executing a program) to the data.

As outlined below, the Upgrade Programme will provide the resources to create the computing infrastructure that will underpin the daily work on the enhanced beamlines.

A new data centre

Data storage, tape back-up devices, HPPC clusters and a significant amount of network electronics are currently installed in two physically separated computer rooms. The original computer room, located on the ground floor of the ESRF Central Building has served since 1990. With a surface of 207m² (including several adjacent smaller rooms for terminals, poster printers and storage), the room became saturated in 2001. The project of a second computer room was unavoidable and led to the extension of the control room building, creating an additional usable surface of 133 m². This new room was put into operation at the beginning of 2003 and was being used to its full capacity just 2 years later. Given the critical nature of the data on the storage systems, the data are mirrored between the two computer rooms, installing the disk storage systems in one room and the tape back-up systems in the other. Additional capacity in the current rooms is limited by their available cooling power and uninterruptible power supply (UPS) power. The situation at the beginning of 2007 is summarised in **Table 3.3.1**.

| | Computer Room CTB-054 | Computer Room CTRM-106 |
|------------------------------|-----------------------|------------------------|
| Surface area | 207 m ² | 133 m ² |
| Surface area used | ~ 70% | ~ 60% |
| UPS Power installed | 80 kVA | 160 kVA(*) |
| UPS Power used | 70 kW | 59 kW |
| Cooling Power installed | 75 kW | 70 kW |
| No. of 19" racks | 33 | 26 |
| Tape robots | 4 | 1 |
| Additional equipment in 2007 | 5 kW | 15 kW |

Table 3.3.1: The ESRF computer rooms in 2007.

(*) The same UPS supplies two other technical rooms in the CTRM building used for controlling the accelerator complex.

The requirement of increased power and cooling originates from the fact that the data rate of the ESRF beamlines increases significantly faster than the processor speed of modern computers. Consequently, we have to install more computers to be able to run analysis programs at constant speed for data intensive experiments. This computing power will be even more critical if we wish to provide feedback on

experimental results in real time. For some beamlines this would require at least one order of magnitude more processing power. With our current infrastructure close to saturation, we must make sure that we can accommodate the additional storage, back-up, and processing power needed to support the new science of the Upgrade Programme over the next 10 to 20 years.

A new data centre is planned that will replace much of the original Central Building Computer room. Only half of the network equipment (about ten 19" racks) has to remain in the Central Building location. The main characteristics of the new data centre will be:

| | |
|-------------------|--------------------|
| Surface area: | 500 m ² |
| Useable Height: | 250 cm |
| UPS power: | 500 kW |
| Air Conditioning: | 750 kW |

The new data centre will be pre-equipped with standard racks for long-term homogeneity and for optimum cooling (the so-called "hot aisle, cold aisle" principle). The new room will initially be used at about 25% of its power capacity and 40% of its floor space, accommodating then about forty 19" racks, four mid-sized tape robots, and one large tape robot. Over the first 10 years, it is most likely that another 30–40 racks will be added, essentially with commodity server computers for data analysis, disk storage systems and Grid computers. If the current trend of more CPU power for fewer watts consumed continues, then the proposed data centre capacity should suffice for the foreseeable future.

Data communication network

The data communication network is the backbone for transporting the huge amounts of data between the experiment computers and the file servers and for reading the data by the analysis programs and presenting the results to the scientists. At present, the backbone is made up of 10 Gbps links between main routers, 1 Gbps dedicated links between the experiment computers and the central file servers and 100 Mbps switched network for the remaining computers. With the increasing volume of data to transport and the requirement to analyse and visualise the data online, the data communication network needs to be continuously upgraded. We propose to upgrade the entire network such that the available bandwidth is increased by at least one order of magnitude. This means 100 Gbps for the backbone network, 10 Gbps for dedicated links between the beamlines and the data centres, and 1 Gbps for the remaining network. This requires upgrading and complementing the network switches in the computer rooms and on the beamlines and upgrading the copper cabling on the beamlines and in the offices.

Another significant networking development is the vast increase in the demand for network ports. This is triggered mostly by the replacement of almost all existing field buses, including serial lines, by Ethernet as the de facto standard. This can mean up to a hundred fold increase in the number of network ports required in the future. For example, if all of the devices currently connected to field buses in the accelerator control system are eventually moved to Ethernet (and the trend has already started), we will require up to 5000 network ports for the accelerators. The future network infrastructure will be dimensioned to cater for these needs.

Data storage and back-up

The exponential growth of the data output of the ESRF beamlines is expected to continue, in line with what we have experienced over the last 10 years. Over that time span, the data rate has been multiplied by a factor of 300 and stands now at more than 1 TB/day. The ESRF online disk capacity required to store raw data and intermediate files for the duration of the data analysis will soon cross the petaByte barrier (1 PB = 1×10^{15} Bytes). Although we do not expect difficulties in providing the required storage capacity in the near future, we must find innovative solutions to increase the performance at the same rate as capacity increases. Pixel detectors, the new versions of our in-house developed FRELoN camera and also commercially available detectors will generate several hundred Mbytes/s, and online data

processing will require high bandwidth parallel access to the data. An example where the data storage and processing requirements are already quite high is tomography. The 7 million-year-old Toumaï skull (Figure 3.3.7) was studied on the beamline ID17 using microtomography techniques. Measured with a resolution of 45 μm per pixel, the raw data set corresponds to 400 GBytes. The different intermediate data processing steps require several TBytes of disk storage and weeks of CPU time on a small computer cluster. In the future, similar measurements will be done with much higher resolution, requiring unprecedented storage and processing capabilities, thus requiring an enhanced computing infrastructure.

Data files are currently stored and accessed via their physical location on the file servers. This is often a source of confusion for users and limits the storage size and performance for a given experiment to the physical properties of the file server. As part of the Upgrade Programme, we propose to virtualise the data storage. This means users will see a single storage area (also called "global name space"), independent of the underlying physical hardware and constituted by several file servers. Bandwidth can then be aggregated and allocation and resizing of data areas to experiments will be much easier and can be done on the fly.

Data are still predominantly exported using physical media such as portable hard disks, tapes, DVDs and CDs. This is partly due to the difficulties of exporting large amounts of data reliably over the network. We propose to install new protocols such as GridFTP and RFT (Reliable File Transfer) for transferring large amounts of data so that some users can export or access their data more reliably and efficiently via the Internet.

Even with the relatively simple data structure of synchrotron experiments, data management is increasingly a major issue. It will be necessary to merge the capabilities of a file system to store and transmit bulk data from experiments, with logical organisation of files into indexed data collections, allowing efficient query and analytical operations. It is also necessary to incorporate extensive metadata describing each experiment and the data it produced. Rather than flat files traditionally used in scientific data processing, the full power of relational databases is needed to allow effective interactions with the data and an interface which can be exploited by the scientific toolkits available, for purposes such as visualisation and plotting.

High-performance parallel computing

High-performance computing resources have become more affordable in recent years through the purchase



copyright MPFT

Figure 3.3.7: The 7 million-year-old Toumaï skull was studied on beamline ID17 using microtomography techniques. It is believed to belong to the earliest pre-human ancestor. Microtomography will be one of the largest data producers at the ESRF following the Upgrade. Computer resources will be necessary to analyse, manage, curate and distribute these data. One proposal concerns the scanning of hundreds of fossils to enable an online data library allowing scientists to access the tomographic data from around the world.

of clusters of PCs that are configured in an HPPC environment. Today, inexpensive PC clusters can provide similar computing capabilities compared with formerly large supercomputers costing millions of Euros. The challenge of creating such clusters has shifted from hardware to efficient management and support. This trend will be even more emphasised by the complexity of the Grid software which will run on top of most of our clusters in the near future.

Centralising clusters in an optimal environment, as well as entrusting the installation and configuration to a single support group has proven very cost effective and efficient, avoiding a doubling of effort at the level of individual beamlines. We have to continue providing a centrally cost effective and scalable HPPC solution that can be used to support the wide spectrum of research at the ESRF.

A key element of success of the HPPC clusters will be the software for parallel batch submission of jobs, interactive parallel processing, as well as the project-oriented allocation of CPU power by Grid software. A substantial long-term effort is required to install and optimise each of the many software packages used for data analysis.

3.3.9. Collaboration and European projects

Collaboration with external partners is a very important source of inspiration and an effective means of increasing the added value of the ESRF's software platform. All possible efforts will be made to set up collaborations with other European light sources and user groups to reuse existing software and share the development effort. Where possible, collaborations will be instigated with the program authors and developers to enlist their help so that the work done at the ESRF is integrated with the standard versions of the programs. This will ensure that the synchrotron community as a whole will benefit from the work undertaken at the ESRF.

Collaboration within software projects

The following example presents the kind of collaboration that is needed to achieve the aim of online data analysis for all experiments. It highlights a collaborative project for automatic data collection that has enhanced the ESRF macromolecular crystallography beamlines. DNA (automateD collectioN of datA, www.dna.ac.uk) is a successful collaboration between major synchrotron radiation facilities in Europe and other laboratories that provide third party software. This collaboration is funded via the BioXHIT (FP6) project (www.bioxhit.org). Today,

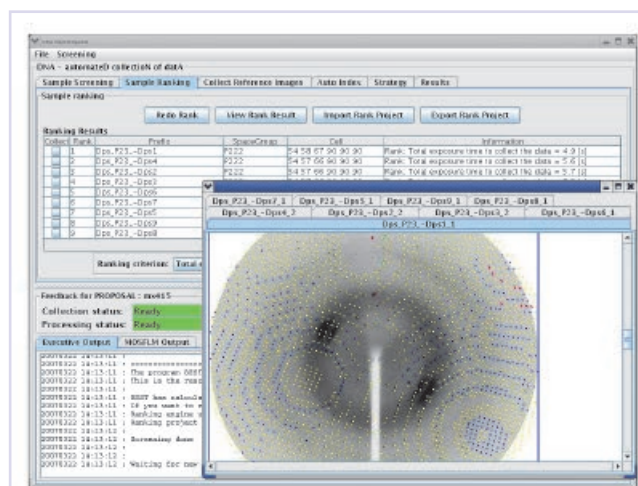

Figure 3.3.8: The DNA user interface, as used on the ESRF MX beamlines, with a list of ranked samples and an image with the predicted pattern overlaid on the collected diffraction pattern.

the DNA system is used on eight MX stations at the ESRF (Figure 3.3.8). DNA is also installed at EMBL Hamburg (Germany) and NSLS (BNL, USA), and will soon be installed at Diamond. DNA provides automatic ranking of screened samples and real-time data analysis by automatically integrating images as they are collected, thus rapidly providing information about the data quality as data collection finishes.

Virtual data analysis centre

The tasks described in detail in this chapter are all stepping stones to the eventual creation of a Virtual European Synchrotron Radiation Data Analysis Centre. Our users require easy-to-use analysis program suites for their science. The task of creating such suites for different sciences is too large for one institute. We envisage creating a European collaboration to address this problem in the future. Discussions have already started with other light source facilities in Europe and we plan to make proposals for European funds during the timescale of the Upgrade Programme.

References

- Beteva A., Cipriani F., Cusack S., Delageniere S., Gabadinho J., Gordon E.J., Guijarro M., Hall D.R., Larsen S., Launer L., Lavault C.B., Leonard G.A., Mairs T., McCarthy A., McCarthy J., Meyer J., Mitchell E., Monaco S., Nurizzo D., Pernot P., Pieritz R., Ravelli R.G.B., Rey V., Shepard W., Spruce D., Stuart D.I., Svensson O., Theveneau P., Thibault X., Turkenburg J., Walsh M., and McSweeney S.M. (2006), High throughput sample handling and data collection at synchrotrons: embedding the ESRF into the high-throughput gene-to-

structure pipeline, *Acta Crystallogr.*, **D62**, 1162-1169.

- Bravin A., Mocella V., Coan P., Astolfo A., and Ferrero C. (2007), A numerical wave-optical approach for the simulation of analyzer-based X-ray imaging, *Opt. Express*, **15**, 5641-5648.
- Foster I., Kesselman C., and Tuecke S. (2001), The anatomy of the grid: enabling scalable virtual organizations, *Int. J. Supercomput. Appl.*, **15**.
www.globus.org/alliance/publications/papers/anatomy.pdf.
- Freud N., Létang J.M., Mary C., Boudou C., Ferrero C., Elleaume H., Bravin A., Estève F., and Babot D. (2007), Fast Dose Calculation for Stereotactic Synchrotron Radiotherapy, Conference Proceeding of the Annual International Conference of the IEEE Engineering in Medicine and Biology EMBC'07, Lyon, France, August 23-26, 2007.
- Goetz A., Meyer J., Taurel E., and Klotz W.-D. (1999), TANGO - an object oriented control system based on

CORBA, ICALEPCS 1999, Trieste, Italy.

- Mirone A., Dhési S.S., and van der Laan G. (2006), Spectroscopy of $\text{La}_{0.5}\text{Sr}_{1.5}\text{MnO}_4$ orbital ordering: a cluster many-body calculation, *Eur. Phys. J. B*, **53**, 23-28.
- Mirone A., Bouchenoire L., and Brown S. (2007), X-ray resonant magnetic scattering: polarisation dependence in the non-spherical case, *Acta Crystallogr.*, **A63**, 348-353.
- Peterzol A., Berthier J., Duvauchelle P., Ferrero C., and Babot D. (2007), X-ray phase contrast image simulation, *Nucl. Instrum. Methods Phys. Res. B*, **254**, 307-318.
- Solé V.A., Papillon E., Cotte M., Walter Ph., and Susini J. (2007), A multiplatform code for the analysis of energy-dispersive X-ray fluorescence spectra, *Spectrochim. Acta Part B*, **62**, 63-68.
- Vaughan G.B.M., Schmidt S., and Poulsen H.F. (2004), Multicrystal approach to crystal structure solution and refinement, *Z. Kristallogr.*, **219**, 813-825.



The European Light Source

ESRF SCIENCE AND TECHNOLOGY PROGRAMME 2008-2017

PART 4

Cost, staff and schedule



Cost, staff and schedule

This part contains the estimates of financial cost and additional staffing, and the preliminary planning schedule for the ESRF Upgrade. The subsequent planning stages will identify the costs and schedule in more detail.

4.1. Cost and additional staffing

4.1.1. Introduction

First cost estimates have been made for the major programme components as defined at the current stage of planning. These estimates are indicative and based on experience with similar programmes, components and projects at the ESRF and elsewhere. They have to be verified in detail, and the cost breakdown will be refined during subsequent planning stages. However, budget details will not be disclosed to the public in order to avoid jeopardising the calls for tender.

10% contingencies will be added to the budget for capital investments. These contingencies for unforeseen extra costs will become available only upon specific Council approval.

All costs are given in 2008 prices.

It is estimated that 30 additional staff will be required during both the project phase and the later operational phase.

4.1.2. Infrastructure capital investment

The major enhancement to the ESRF infrastructure is the extension of the Experimental Hall. About 21,000 m² will be added to the existing surface, which corresponds to an increase of roughly 30%. Although work on this task has already started, it will progress more rapidly during and after 2008 with the appointment of the architect and engineering team. The buildings are expected to be available by the end of 2011. The total estimated costs are 42 million euro (M€), to be spent according to the profile shown in [Table 4.1.1](#).

4.1.3. Accelerator and source capital investment

The upgrade of the X-ray source comprises the following main projects:

- Increase length of straight sections
- New undulators and canting options
- Current increase with associated radio frequency systems upgrade
- Top-up injection and new timing modes
- Very short pulsed X-ray beam
- Lattice studies

These development activities will take place over a period of 10 years. The foreseen expenditure profile is presented in [Table 4.1.2](#).

| 2008 | 2009 | 2010 | 2011 | 2012 | 2013 | 2014 | 2015 | Total (M€) |
|------|------|-------|-------|------|------|------|------|--------------|
| 0.53 | 8.77 | 12.96 | 12.59 | 6.38 | 0.32 | 0.31 | 0.15 | 42.01 |

Table 4.1.1: Cost estimate (M€) and yearly distribution for the infrastructure investment programme.

| 2008 | 2009 | 2010 | 2011 | 2012 | 2013 | 2014 | 2015 | 2016 | 2017 | Total (M€) |
|------|------|------|------|------|-------|------|------|------|------|--------------|
| 0.26 | 5.17 | 4.10 | 4.06 | 5.19 | 10.10 | 6.89 | 5.51 | 1.86 | 1.86 | 45.00 |

Table 4.1.2: Cost estimate (M€) and yearly distribution for the accelerator and source investment programme.

4.1.4. Experiments capital investment

The investment programme for new beamlines and refurbishments allows the entire reconstruction of ten long beamlines in the extended Experimental Hall together with six normal length beamlines composed of four canted beamlines and two standard (*i.e.* non-canted) ones. A provision for the relocation of two beamlines in order to optimise the use of floor space and operational efficiency is also included. It should be noted that a prioritisation of the beamline projects remains to be made and that this may affect the ratio of long, canted and normal beamlines given above. Within the set of conceptual design reports, there are currently too many proposals for the number of ESRF straight sections and a selection, probably in several phases of design and construction, will need to be made with advice from the ESRF Science Advisory Committee.

The ESRF's share in the costs of the High Magnetic Field Lab (HMFL) is calculated at 15 M€, the two associated beamlines at 5 M€ each.

Based on the current considerations, a total investment programme of 108.40 M€ is planned, starting in 2009 (Table 4.1.3).

| | 2009 | 2010 | 2011 | 2012 | 2013 | 2014 | 2015 | 2016 | 2017 | Total (M€) |
|-------------------|------|------|------|------|------|-------|-------|-------|-------|---------------|
| BL invest. | 6.92 | 7.61 | 7.80 | 8.16 | 8.21 | 12.54 | 12.78 | 10.64 | 8.74 | 83.40 |
| HMFL | | | | | 1.35 | 3.40 | 5.93 | 7.78 | 6.54 | 25.00 |
| Total (M€) | 6.92 | 7.61 | 7.80 | 8.16 | 9.56 | 15.94 | 18.71 | 18.42 | 15.28 | 108.40 |

Table 4.1.3: Cost estimate (M€) and yearly distribution for the experiments investment programme.

| 2008 | 2009 | 2010 | 2011 | 2012 | 2013 | 2014 | 2015 | 2016 | 2017 | Total (M€) |
|------|------|------|------|------|------|------|------|------|------|--------------|
| 0.31 | 4.94 | 3.24 | 3.24 | 3.24 | 3.24 | 3.24 | 3.24 | 3.24 | 3.24 | 31.17 |

Table 4.1.4: Cost estimate (M€) and yearly distribution for the beamline support investment programme.

| 2008 | 2009 | 2010 | 2011 | 2012 | 2013 | 2014 | 2015 | 2016 | 2017 | Total (M€) |
|------|------|------|------|------|------|------|------|------|------|--------------|
| 0.40 | 1.17 | 1.98 | 2.30 | 1.03 | 1.24 | 1.13 | 0.94 | 0.84 | 0.83 | 11.86 |

Table 4.1.5: Cost estimate (M€) and yearly distribution for the computing investment programme.

4.1.5. Instrumentation and detector development - capital investment

A total expenditure of 31.17 M€ is foreseen over 10 years for the development of beamline instrumentation and detector developments (Table 4.1.4). The planning is not yet sufficiently advanced to allow a more specific spending profile to be shown at this stage. The 2008 and 2009 expenditure is planned as 0.31 M€ and 4.94 M€ respectively, and the remainder is currently placed in equal instalments over the period. Once beamline priorities are known, detailed planning of the associated engineering projects will be made.

4.1.6. Computing capital investment

The Upgrade Programme necessitates a new expanded computing centre and a massive expansion of storage and network capacities. A total of 11.86 M€ is foreseen to be spent in a fairly flat profile (Table 4.1.5).

4.1.7. Recurrent

Additional recurrent costs for the Upgrade Programme during the construction phase are linked to the extension of the surface, the expansion of services and the increased use of consumables, in particular electricity and fluids, with a clear increase towards the term of the project. In detail, it is estimated that:

- Additional costs for building maintenance (cleaning, air conditioning, heating) are calculated at 0.8 M€ per years of 2012, when the major extension works are finished;
- The 300 mA operation incurs higher electricity consumption (0.45 M€ as of 2008), which again have to be increased gradually with the installation of new RF cavities (0.55 M€ in 2013, 0.6 M€ in 2014 and 0.65 M€ as of 2015);

- The actual recurrent costs per beamline amount to 150 k€ per year. With the construction of canted undulators new beamlines will be added, other beamlines will be reconstructed and become more complex to operate. New and refurbished beamlines will become available as of 2012, the additional operational cost will be 0.5 M€ in 2012 and go up to 1.0 M€ as of 2016. The operation of the proposed High Magnetic Field Project will require an extra 1 M€ in 2014 and 3 M€ per year as of 2015 for electricity consumption;
- The computing maintenance costs and software licences, associated with the investment programme

planned in computing infrastructure (new data centre, network, storage and high performance parallel computing clusters) will increase the recurrent expenditure by 0.23 M€/year from 2010;

- Recruitment costs associated with the Upgrade Programme and the expected increased turnover of staff, as well as additional general expenditure for the Administration Division, will be accounted for with 0.1 M€/year from 2009 and with 0.2 M€ from 2012.

In summary, the recurrent costs associated with the Upgrade Programme will increase following the cost profile presented in Table 4.1.6.

| 2008 | 2009 | 2010 | 2011 | 2012 | 2013 | 2014 | 2015 | 2016 | 2017 | Total (M€) |
|------|------|------|------|------|------|------|------|------|------|--------------|
| 0.45 | 0.55 | 0.78 | 0.78 | 2.18 | 2.28 | 3.33 | 5.38 | 5.88 | 5.88 | 27.49 |

Table 4.1.6: Provisional recurrent cost profile.

4.1.8. Personnel

The ESRF staff complement needed to operate the facility as it stands requires 582 positions, i.e. 552 regular ESRF staff, plus an average of 30 positions per year funded by external sources. The majority of these staff will be heavily involved in the Upgrade Programme whilst maintaining optimal operation of the facility.

To help the Upgrade Programme to be realised effectively, the existing skills of the ESRF staff will be used and further developed. The internal and thematic mobility of staff will be a challenge and a fundamental requirement as projects are initiated and develop within the Upgrade framework. The retirement of at least 50 staff over the coming 10 years will provide flexibility in the assignment of new tasks. Nevertheless, additional staff will be needed during the planning and realisation phases, and operation of the upgraded facility will require 30 additional permanent posts.

During the project, additional staff will be needed, in particular to provide support to the Technical Services Division for the extension of the Experimental Hall;

to the Accelerator and Source Division, the Experiments Division and the Computing Service Division in the fields of nano-engineering and detectors, for the improvement of computing resources, as well as for preparation work for the lengthened accelerator straight sections and for the construction of the long beamlines. A recruitment plan has been prepared. It is based upon the Upgrade Programme projects outlined above and will, in part, make use of fixed-term employment contracts. The project will require 5 support staff on average during 2008, rising to 20 in 2009, and with a maximum of 30 during subsequent years. Towards the end of the project phase the staff complement will decrease to 25, which is also the estimated number of additional staff required for the operation of the upgraded facility beyond 2017. A preliminary estimation indicates that the following staff will be needed at the maximum of the project phase:

- 12 additional staff to support the enhanced user programmes on the upgraded, technically and scientifically more demanding beamlines.
- 11 new staff to continue effort in the fields of detectors, electronics, computing and sample environment.
- A further 7 posts to service the increased building

| | 2008 | 2009 | 2010 | 2011 | 2012 | 2013 | 2014 | 2015 | 2016 | 2017 | Total (M€) |
|--------------|------|------|------|------|------|------|------|------|------|------|--------------|
| Staff number | 5 | 20 | 25 | 25 | 25 | 30 | 30 | 30 | 25 | 25 | |
| Cost (M€) | 0.41 | 1.65 | 2.09 | 2.11 | 2.14 | 2.60 | 2.62 | 2.65 | 2.23 | 2.27 | 20.77 |

Table 4.1.7: Cost estimate and yearly distribution for the additional staff.

infrastructure (Experimental Hall and laboratory space) and to cope with increased workloads in the areas of safety and administration.

For the 10 year project period, the recruitment of additional support staff is foreseen with the yearly staff numbers and distribution of costs shown in [Table 4.1.7](#).

To the extent of their involvement in the Upgrade Programme, existing staff will be included in the Upgrade Project in terms of Full Time Equivalents (FTE) at a later stage, when the detailed planning is sufficiently advanced. This will not necessitate additional funding requests.

4.1.9. Current annual ESRF budget and Upgrade Programme

The Upgrade project will be realised while normal operation of the facility continues in user mode. It is assumed that the financing of the ESRF operation will be maintained at the current level. To the extent of reduced activities for normal operation during the construction period (e.g. no user operation during shutdowns, no user operation at some beamlines during their rebuild, refurbishment or relocation, reduced refurbishment programme for the beamlines not concerned by the Upgrade Programme), a fraction of the normal budget will be used to co-finance the Upgrade activities. This is shown with respect to capital costs in [Table 4.1.8](#). The annual rate of the contribution from the regular budget to the Upgrade Programme foresees a maximum in the middle of the construction period and a flattening out towards the end ([Table 4.1.8](#)).

The use of part of the normal ESRF working budget to co-finance the Upgrade Programme allows a planning of the spending profile which keeps the necessary contributions from Members and Associates at a stable level during the whole project period. With the assumption that the level of Members' contributions is kept at 70 M€/year during the whole period, additional contributions are needed, with the yearly distribution shown in [Table 4.1.9](#).

If requests for additional funding of activities covered by the Upgrade budget from the EU or other financing bodies are successful, this may reduce the level of additional funding by the Members and Scientific Associates. Following the completion of the Upgrade Programme, the annual ESRF budget will have to be adapted to the increased requirements of the upgraded facility.

| | 2008 | 2009 | 2010 | 2011 | 2012 | 2013 | 2014 | 2015 | 2016 | 2017 | Total (M€) |
|---------------------------|-------|-------|-------|-------|--------|--------|--------|-------|-------|-------|---------------|
| Initial normal budget | 13.35 | 13.35 | 13.35 | 13.35 | 13.35 | 13.35 | 13.35 | 13.35 | 13.35 | 13.35 | 133.50 |
| Support to Upgrade | -2.36 | -6.35 | -8.35 | -9.35 | -10.35 | -11.35 | -10.85 | -9.85 | -6.85 | -0.99 | -76.65 |
| New normal budget | 10.99 | 7.00 | 5.00 | 4.00 | 3.00 | 2.00 | 2.50 | 3.50 | 6.50 | 12.36 | 56.85 |
| Additional for Upgrade | - | 20.62 | 21.54 | 20.64 | 13.65 | 13.11 | 16.66 | 18.70 | 17.51 | 20.22 | 162.65 |
| Total capital for Upgrade | 1.50 | 26.97 | 29.89 | 29.99 | 24.00 | 24.46 | 27.51 | 28.55 | 24.36 | 21.21 | 238.44 |

Table 4.1.8: Injection of funds from the regular budget into the capital budget of the Upgrade Programme (M€).

| | 2008 | 2009 | 2010 | 2011 | 2012 | 2013 | 2014 | 2015 | 2016 | 2017 | Total (M€) |
|--|------|------|------|------|------|------|------|------|------|------|---------------|
| | - | 23.3 | 23.3 | 23.3 | 23.3 | 23.3 | 23.3 | 23.3 | 23.3 | 23.3 | 210.05 |

Table 4.1.9: Cost estimate (M€) and yearly distribution for the additional funding required by the Upgrade Programme.

4.1.10. Summary

The estimated total of 286.70 M€ breaks down as follows:

- Capital** 238.44 M€, of which 76.65 M€ will be financed from the regular budget
- Recurrent** 27.49 M€ in addition to the normal budget
- Personnel** 20.77 M€ for additional support staff (30 maximum).

Figures 4.1.1 and 4.1.2 present graphical views of the budget allocation per programme component and per year.

A contingency of 10% of the capital investments will be added to the capital costs.

The budget of the Upgrade Programme will be managed within the existing budgetary rules in force at the ESRF which provide sufficient flexibility, within the budget limits, whilst assuring detailed and continuous reporting.

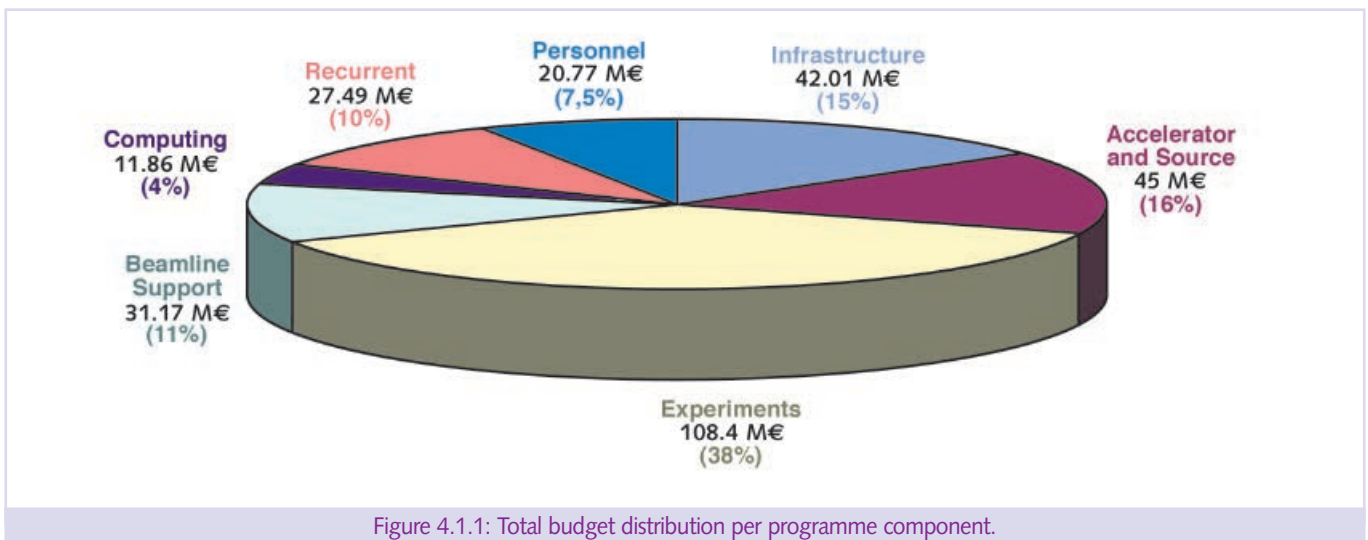

Figure 4.1.1: Total budget distribution per programme component.

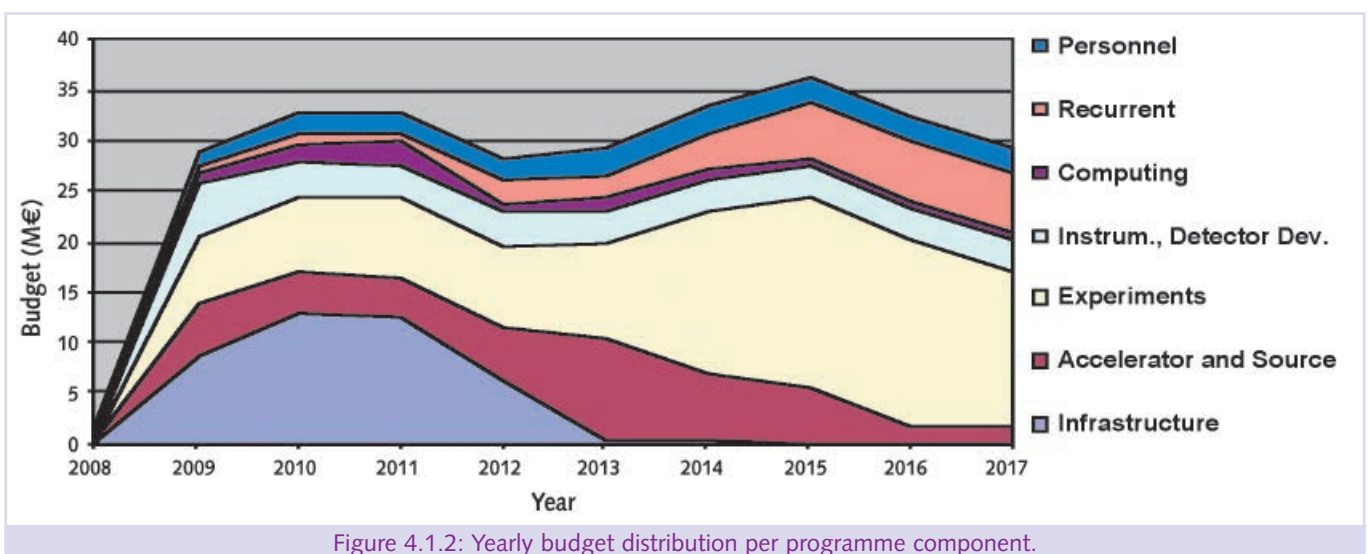

Figure 4.1.2: Yearly budget distribution per programme component.

4.2. Planning the ESRF Upgrade

4.2.1. Introduction

Annexe I of this scientific and technical report on the future ESRF science programme contains Conceptual Design Reports (CDRs) which outline the ideas, inspired by new science, for new and enhanced ESRF beamlines. These CDRs were reviewed in late 2006 by the Science Advisory Committee, the Beam Time Allocation Panel Chairs, the ESRF Users Organisation Representatives and the Chair of Council. A number of other key experts were also asked to give their comments. The CDRs, feedback on them, and new science, were discussed at a special meeting on 14th February 2007 with the Chair of Council, the SAC Coordinating Group and the Experiments Division Management Board. This meeting provided the foundation for this report.

In parallel with work on the CDRs, a survey on the technological requirements to enable the new beamlines was carried out. The results of this survey form the basis for the future technological developments and the strategies necessary to set them up. A key component of the Upgrade will be extensions to the current experimental hall to give increased length and space to beamlines and new facilities. The boundaries to these extensions have been defined and formalised.

Initial budgetary and staffing plans for the Upgrade have been prepared. Once priorities have been identified for the component projects of the Upgrade, these will be refined.

The various constituents of the Upgrade have reached different levels of maturity, with some at the stage of feasibility studies (for example, the high magnetic field project), some at the stage of projects being chosen for detailed technical studies (for example, which beamlines to extend and upgrade), whereas others are at the project planning stage with solutions identified and able to be initiated rapidly once funding approval is given (for example, operating the storage ring with 300 mA current). Planning is being made in accordance with these variations and with the assumption of launching several Upgrade tasks from 2008. An application to the EU Framework 7 Preparatory Phase call (FP7-INFRASTRUCTURES-2007-1), which is limited to projects listed on the first ESFRI roadmap, has been made. It will catalyse the development of the ESRF Science and Technology Programme 2008-2017 into detailed project plans for the ESRF Upgrade. At this time, contracts are being finalised.

The chart (Figure 4.2.1) shows the preliminary planning of the main Upgrade components over the ten-year project lifetime. Detailed planning will be made once the scientific priorities have been identified, at least for the first phase of beamlines to be constructed or refurbished.

4.2.2. Beamlines

An information and discussion meeting will be held on 24th October 2007 with external scientists chairing sessions on the future ESRF science and technology programme. This meeting has three aims:

- Inform the community on the project status, the new science and technology;
- Gather feedback, validate ideas and perspectives leading to reports;
- Indicate project priorities (areas, directions).

With the help of the Science Advisory Committee, priorities for the first phase of new and upgraded beamlines will be decided upon and the relevant Conceptual Design Reports developed into Technical Design Reports (TDRs). The TDRs will detail the beamline optical design, expected performance, project budget and timeline and will be the basis for agreement to initiate actual beamline projects of the Upgrade. The set of TDRs for the first phase of beamlines will be ready for end 2009 to allow approval and design work to be completed ready for the availability of the experimental hall extensions (for the long beamlines).

4.2.3. Experimental hall extensions

The development of the extensions to the experimental hall is a complex task, requiring about 45 months of technical and architectural study and work. Drafting of the dossier defining the extensions in readiness for call for tender for the architect and engineering team is underway. Subject to finance being available at the start of 2008, the buildings will be available at the end of 2011, allowing the construction of new long beamlines to start in early 2012. The ESRF is an operational institute with 6000 users coming annually to use the beamlines. During the Upgrade this operation will be maintained at the highest level possible, though several shutdowns of the facility to allow the major building works are inevitable.

4.2.4. Accelerator and source developments

Several projects will be carried out simultaneously. The transition to 7 m long straight sections will take place at the rhythm of one or two per year following a

period of study and prototyping of about three years needed to design and build the high gradient quadrupoles. The ramping of current to 300 mA in user operation will start in 2008, once the feedback has been fully commissioned and all the crotch absorbers have been replaced. The commissioning of the new RF transmitters and RF cavities will be spread over the ten years after a design and preparatory phase.

4.2.5. Enabling instrumentation and technology

The beamline instrumentation, engineering and computing projects are at various levels of readiness: solution proposal, project planning and, in some cases, projects already running using current ESRF resources. Synchronisation of the projects, especially detector and nano-compatible engineering development, with the beamline projects will be necessary once priorities are known.

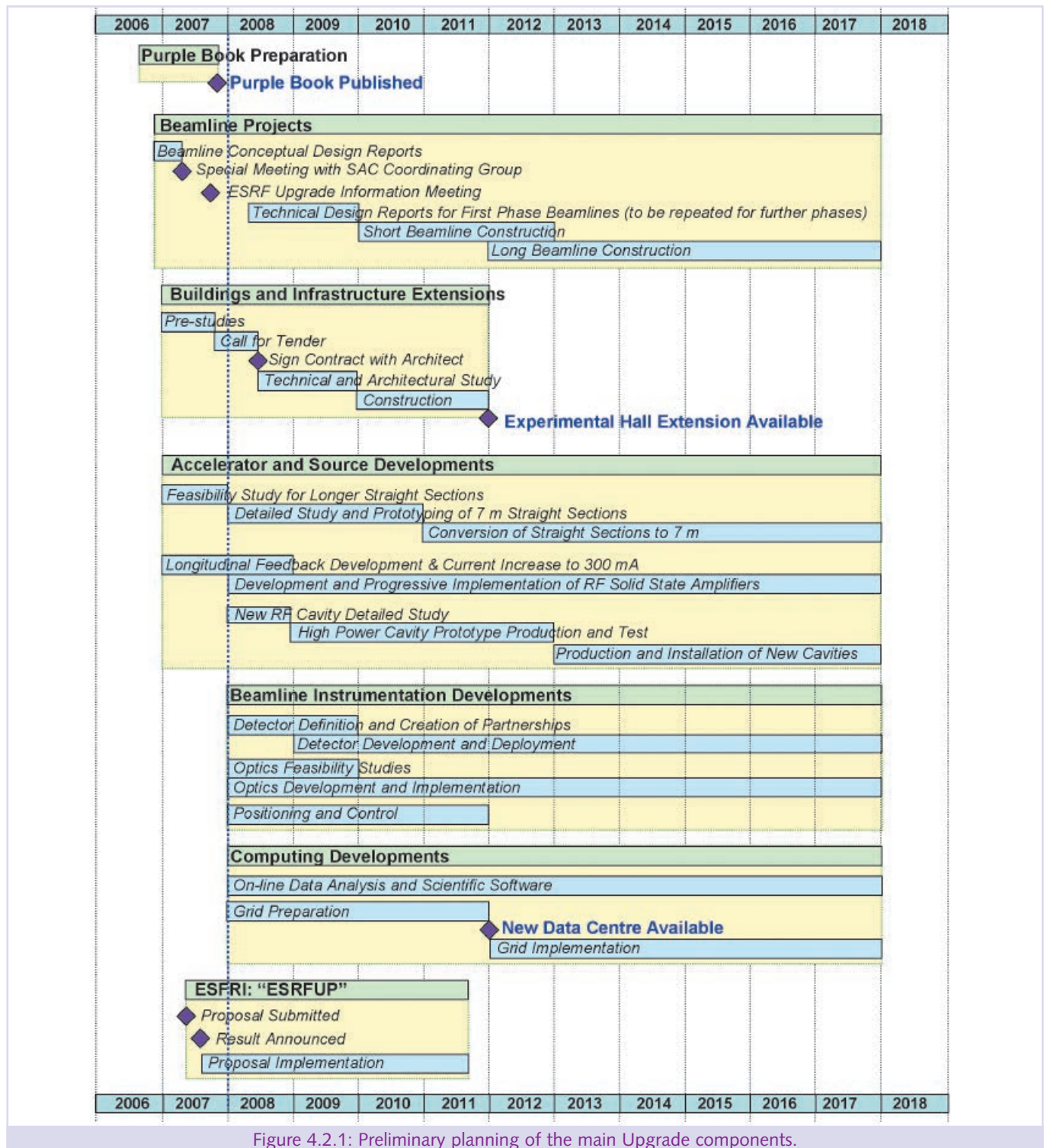

Figure 4.2.1: Preliminary planning of the main Upgrade components.



The European Light Source

ESRF SCIENCE AND TECHNOLOGY PROGRAMME 2008-2017

Glossary and Contributors

Glossary

Conceptual Design Report Acronyms

| | |
|----------------------------|--|
| CDI | Coherent X-ray Diffraction Imaging and Microdiffraction |
| CPR | Development of Clinical Protocols in Radiotherapy |
| DICHRO | Polarisation Dependent X-ray Spectroscopy |
| EDXAS-L | Energy Dispersive Absorption Spectroscopy (large spot) |
| EDXAS-S | Energy Dispersive Absorption Spectroscopy (small spot) |
| EMS | Engineering Materials Science |
| EXAFS | Extended X-ray Absorption Fine Structure Spectroscopy |
| GISD | Grazing Incidence Scattering and Diffraction |
| HIENE | High Energy X-ray Beamline |
| HIPRE | High Pressure Technique Beamlines |
| HISAXS | High Throughput Small Angle X-ray Scattering |
| HXPM | Hard X-ray Photoelectron Microscopy |
| IMPACT | Imaging using Parallel Beam and Computed Tomography |
| INELX | Inelastic X-ray Scattering |
| MAGSCAT | Magnetic Scattering |
| MASSIF | Massively Automated Sample Screening Integrated Facility |
| MATSCI | Materials Science |
| MINADIF | Micro- and Nano-Diffraction |
| MX-BIB | Biological Imaging Beamline |
| MX-MAD1 / MX-MICROFOCUS | Macromolecular Crystallography using Multi-Wavelength Anomalous Dispersion and Microfocus |
| MX-MAD2 | Macromolecular Crystallography using Multi-Wavelength Anomalous Dispersion with Microfocus |
| NR-HE | Nuclear Resonance - High Energy |
| NR-NSM | Nuclear Resonance - Nanoscale Materials |
| OPTICS | Facility for Surfacing Mirror Substrates |
| PHIXS | Phonon Inelastic X-ray Spectroscopy |
| PMF | Pulsed Magnetic Fields |
| POW | High Resolution Powder Diffraction |
| RIXS-PES | High Resolution Resonant Inelastic X-ray Scattering and Photoelectron Spectroscopy |
| SAXS | Small Angle X-ray Scattering |
| SFINX | Scanning Fluorescence and Imaging at the Nanoscale using X-rays |
| SMILE | Spectro-Microscopy and Imaging at Low Energies |
| SMS | Resonant Soft X-ray Magnetic Scattering |
| SURF | Surface Diffraction |
| TIBIDI | Technical Beamline for Instrumentation Development |
| TRD | Time-Resolved Diffraction and Pump-and-Probe |
| WIBIDI | White Beam Technical Development Beamline |
| XAS-XES | Steady-State and Time-Resolved X-ray Absorption and Emission Spectroscopy |
| XMAN | X-ray Spectroscopy Multi-Imaging Analysis |
| XPCS-CXS | X-ray Photon Correlation Spectroscopy and Coherent X-ray Scattering |

Other Abbreviations

| | |
|--------|--|
| μXRF | μX-ray Fluorescence |
| 3DXRD | Three Dimensional X-ray Diffraction |
| ABI | Analysers Based Imaging |
| AD | Anomalous Dispersion |
| AFM | Atomic Force Microscopy |
| APD | Avalanche Photo Diode |
| ARPES | Angle Resolved Photoemission Spectroscopy |
| ASAXS | Anomalous Small Angle X-ray Scattering |
| ATEM | Analytical Transmission Electron Microscopy |
| AXRD | Anomalous X-ray Diffraction |
| BBB | Blood Brain Barrier |
| BMF | Bio-Medical Facility |
| BPM | Beam Position Monitor |
| CBV | Cerebral Blood Volume |
| CCD | Charge Coupled Device |
| CDI | Coherent Diffraction Imaging |
| CDR | Conceptual Design Report |
| CISB | Centre for Integrated Structural Biology |
| CMOS | Complementary Metal Oxide Semiconductor |
| CMR | Colossal Magneto Resistance |
| COD | Computing On Demand |
| CPU | Central Processing Unit |
| CRG | Collaborating Research Group |
| CRL | Compound Refractive Lenses |
| CT | Computer Tomography |
| CVD | Chemical Vapour Deposition |
| CW | Continuous Wave |
| CXDI | Coherent X-ray Diffraction Imaging |
| DAC | Diamond Anvil Cell |
| DAFS | Diffraction Anomalous Fine Structure |
| DBA | Double Bend Achromat |
| DEPFET | Depleted P-channel Field Effect Transistor |
| DLS | Dynamic Light Scattering |
| DOS | Density Of States |
| EDXAS | Energy Dispersive X-ray Absorption Spectroscopy |
| EGEE | Enabling Grids for E-Science project |
| EPR | Electron Paramagnetic Resonance |
| ERL | Energy Recover Linacs |
| ESCA | Electron Spectroscopy for Chemical Analysis |
| EXAFS | Extended X-ray Absorption Fine Structure |
| FABLE | Framework for Automating Beamlines and Experiments |
| FEL | Free Electron Laser |
| FEM | Finite Element Method |
| FIB | Focused Ion Beam |
| FTIR | Fourier Transform Infrared |
| FWHM | Full Width Half Maximum |
| GID | Grazing Incidence Diffraction |

| | |
|-----------|---|
| GINRS | Grazing Incidence Nuclear Resonance Scattering |
| GIS | Grazing Incidence Diffuse Scattering |
| GISAXS | Grazing Incidence Small Angle X-ray Scattering |
| GIWAXS | Grazing Incidence Wide Angle Scattering |
| GOS | Global Ocean Survey |
| GSI | Grid Security Infrastructure |
| HAXPES | Hard X-ray Photoelectron Spectroscopy |
| HERCULES | Higher European Research Course for Users of Large Experimental Systems |
| HERFD | High Energy Resolution Fluorescence Detected |
| HRM | High Resolution Monochromators |
| HOM | High Order Mode |
| HPPC | High Performance Parallel Computing |
| HXPS | Hard X-ray Photoelectron Spectroscopy |
| HXRD | High Resolution X-ray Diffraction |
| I/O | Input/Output |
| INS | Inelastic Neutron Scattering |
| IOT | Inductive Output Tubes |
| IR | Infra Red |
| IXS | Inelastic X-ray Scattering |
| KB | Kirkpatrick-Baez |
| LCG | Large-Hadron Collider Computing Grid |
| LEED | Low Energy Electron Diffraction |
| LMF | Lamb-Mössbauer Factors |
| LRMO | Long Range Magnetic Order |
| LSF | Load Sharing Facility |
| LVP | Large Volume Press |
| MAD | Multi-Wavelength Anomalous Dispersion |
| MBE | Molecular Beam Epitaxy |
| MCS | Magnetic Compton Scattering |
| MEMS | Micro Electro Mechanical System |
| ML | Multilayer |
| MLL | Multilayer Laue Lenses |
| MOF | Metal Organic Framework |
| MOKE | Magneto Optical Kerr Effect |
| MRT | Microbeam Radiation Therapy |
| MS&E | Materials Science and Engineering |
| MX | Macromolecular Crystallography |
| Nano-SIMS | Nano-Secondary Ion Mass Spectrometry |
| NAPP | Near Ambient Pressure Photoemission |
| NEG | Non Evaporable Getter |
| NEMS | Nano-ElectroMechanical System |
| NFL | NanoFocusing Lenses |
| NFS | Nuclear Forward Scattering |
| NFXS | Near-Field X-ray Scattering |
| NIS | Nuclear Inelastic Scattering |
| NMR | Nuclear Magnetic Resonance |
| NRFS | Nuclear Resonant Forward Scattering |
| NRIXS | Non-Resonant Inelastic X-ray Scattering |
| NRS | Nuclear Resonance Scattering |

| | |
|-----------|---|
| NRXMS | Non-Resonant X-ray Magnetic Scattering |
| PASS | PAtient Safety System |
| PB | PetaByte = 1×2^{50} Bytes |
| PBS | Portable Batch System |
| PDB | Protein Data Bank |
| PDF | Pair Distribution Function |
| PEEM | Photoemission Microscopy |
| POI | Point Of Interest |
| PSD | Position Sensitive Director |
| R&D | Research and Development |
| RC | Reaction Centre |
| RF | Radio Frequency |
| RGA | Residual Gas Analysis |
| RHEED | Reflection High Energy Electron Diffraction |
| RIXS | Resonant Inelastic X-ray Scattering |
| RNA | Ribonucleic Acid |
| RSXS | Resonant Soft X-ray Scattering |
| RT | Radiation Therapy |
| RXS | Resonant X-ray Scattering |
| S/N ratio | Signal/Noise Ratio |
| SAD | Single-Wavelength Anomalous Dispersion |
| SAXS | Small Angle X-ray Scattering |
| SC | Superconducting Cavities |
| SCES | Strongly Correlated Electron Systems |
| SCHM | Series Connected Hybrid Magnet |
| SCM | Soft Condensed Matter |
| SDD | Silicon Drift Diode |
| SEM | Scanning Electron Microscopy |
| SEXAFS | Surface Extended X-ray Absorption Fine Structure |
| SHADOW | General purpose ray tracing software |
| SMIS | Scientific Management Information System |
| SPM | Scanning Probe Microscopes |
| SRCT | Synchrotron Radiation Computed Tomography |
| SRPAC | Synchrotron Radiation based Perturbed Angular Correlation |
| SSCM | Superconducting Split Coil Magnets |
| SSRT | Stereotactic Synchrotron Radiation Therapy |
| STM | Scanning Tunnelling Microscopy |
| SWASER | Spin Wave Amplification by Stimulated Emission of Radiation |
| SXRD | Surface X-ray Diffraction |
| TACO | Telescope and Accelerator Controls Objects |
| TANGO | Taco Next Generation Objects |
| TB | TeraByte = 1×2^{40} Bytes |
| TBA | Triple Bend Achromat |
| TDR | Technical Design Report |
| TDS | Thermal Diffuse Scattering |
| TEM | Transmission Electron Microscopy |
| TXRF | Total Reflection X-ray Fluorescence |
| UHV | Ultra High Vacuum |
| UI | User Interface |

| | |
|-------------|--|
| UPS | Uninterruptible Power Supply |
| USAXS | Ultra Small Angle X-ray Scattering |
| USM | User Service Mode (Operation Time) |
| UV | Ultra-Violet |
| UV-Vis | UltraViolet-Visible light |
| VDOS | Vibrational Density Of States |
| VLS | Variable Line Spacing |
| VO | Virtual Organisations |
| VUV | Vacuum Ultra Violet |
| WAXS | Wide Angle X-ray Scattering |
| XANES | X-ray Absorption Near Edge Structure |
| XAS | X-ray Absorption Spectroscopy |
| XDMR | X-ray Detected Magnetic Resonance |
| XEOL | X-ray Excited Optical Luminescence |
| XES | X-ray Emission Spectroscopy |
| XFEL | X-ray Free Electron Laser |
| XFS | X-ray Fluorescent Spectroscopy |
| XM χ D | X-ray Magneto-chiral Dichroism |
| XMCD | X-ray Magnetic Circular Dichroism |
| XMLD | X-ray Magnetic Linear Dichroism |
| XML | Extended Markup Language |
| XMS | X-ray Magnetic Scattering |
| XnrLD | non-reciprocal X-ray Linear Dichroism |
| XOA | X-ray Optical Activity |
| XOP | X-ray Oriented Programmes software package |
| XPCS | X-ray Photon Correlation Spectroscopy |
| XPEEM | X-ray PhotoEmission Electron Microscope |
| XRD | X-ray Diffraction |
| XRF | X-ray Fluorescence |
| XRI | X-ray Imaging |
| XRR | X-ray Reflectivity |
| XRS | X-ray Scattering |
| XSW | X-ray Standing Wave |
| ZP | Zone Plate |

Notes

List of Contributors

R Abela, G Admans, J Als-Nielsen, D Andrault, G Aquilanti, M Baldwin, R Barrett, J Baruchel, AL Benabid, R Berjon, P Berkvens, P Bernard, JC Biasci, S Blanchon, N Bolfan, G Bomchil, M Bolognesi, J Borrel, D Bourgeois, JF Bouteille, L Braicovich, A Bravin, N Brookes, E Bruas, JY Buffière, T Buslaps, JL Carrascosa, JM Chaize, J Chavanne, M Chergui, A Chumakov, P Cloetens, F Comin, M Cotte, W Crichton, Y Dabin, J Daillant, C Dallera, I Daniel, WH De Jeu, S De Panfilis, JC Deshayes, M Di Michiel, R Dimper, H Dosch, L Dubrovinsky, S Eeckhout, A El Ghazouani, P Elleaume, L Eybert Bérard, P Fajardo, L Farvacque, R Feidenbans'l, R Felici, C Ferrero, G Fiquet, A Fitch, D Flot, P Fornasini, E Gagliadini, G Gbiringbelli, P Glatzel, A Götz, J Goulon, M Grunze, G Guilera, M Habn, D Hall, N Hall, K Hamalainen, M Hanfland, L Hardy, JB Hastings, V Honkimaki, W Hunter, S Huotari, R Kersevan, J Jacob, K Janssens, A Kaprolat, WD Klotz, F Koch, JM Koch, O Konovalov, AM Korsunsky, H Krech, M Krisch, Å Kvick, S Larsen, G Le Duc, B Lebayle, G Leonard, P Mackrill, A Madsen, T Mairs, P Marion, K Martel, O Mathon, M Mattenet, C Mazzoli, A McCarthy, J McCarthy, S McSweeney, T Metzger, M Mezouar, G Monaco, C Morawe, J Morse, C Mueller-Dieckmann, T Narayanan, C Nave, G Naylor, A Nencioni, M Newton, D Nurizzo, L Paolasini, S Pascarelli, W Paulus, P Pernot, L Petit, C Petrillo, JL Plantier, E Plouviez, D Pontoni, I Popa, HF Poulsen, C Prestipino, R Ravelli, M Renier, V Rey-Bakaikoa, C Riekel, M Rodriguez Castellano, A Rogalev, A Ropert, M Rossat, G Rossi, R Rüffer, T Salditt, A Santin, K Scheidt, C Schroer, F Sette, M Sikora, WG Stirling, C Stuck, G Sulzenbacher, J Susini, A Tadjeddine, P Tafforeau, P Theveneau, P Thiry, R Tucoulou, M Vaccari, P van der Linden, P van Vaerenbergh, G Vaughan, L Vincze, E Vlieg, G Vogl, E Weckert, TC Weng, D Wermeille, F Wilhelm, K Wilson, C Woodham, P Woodruff, J Wright, M Wulff, J Zegenbagen, E Ziegler, F Zontone.

The contribution of the people named above was only possible thanks to generous support and goodwill from all ESRF staff.

Editors: T Bouvet, C Detlefs, E Mitchell, JL Revol
September 2007

Proofreading:
Alpha Science Editors
Typesetting:
Pixel Project
Cover design:
Spaced Design Ltd
Printing:
Imprimerie du Pont de Claix

[Terms and Conditions \(PDF version\)](#)

Readers may view, browse, and/or download material for temporary copying purposes only, provided these uses are for noncommercial personal purposes. Except as provided by law, this material may not be further reproduced, distributed, transmitted, modified, adapted, performed, displayed, published, or sold in whole or in part, without prior written permission from the publisher.

ESRF

BP 220, 38043 Grenoble, France

Tel. (33) 4 76 88 20 00 - Fax. (33) 4 76 88 20 20

This publication may be downloaded from the website: <http://www.esrf.eu>

SCIENCE AND TECHNOLOGY PROGRAMME 2008 - 2017

A programme to
upgrade Europe's
strategic centre
for science and
technology research

VOLUME 2

Annexes

September 2007



European Synchrotron Radiation Facility

SCIENCE AND TECHNOLOGY PROGRAMME 2008 - 2017

Annexes

A programme to
upgrade Europe's
strategic centre
for science and
technology research

VOLUME 2
Annexes
September 2007





The European Light Source
SCIENCE AND TECHNOLOGY PROGRAMME 2008-2017

TABLE OF CONTENTS

ANNEXES

| | page |
|--|------------|
| ANNEXE I - CONCEPTUAL DESIGN REPORTS | A3 |
| High Resolution and Resonance Scattering Group | A4 |
| INELX Inelastic X-ray Scattering | A5 |
| NR-HE Nuclear Resonance - High Energy | A6 |
| NR-NSM Nuclear Resonance - Nanoscale Materials | A9 |
| PHIXS Phonon Inelastic X-ray Spectroscopy | A12 |
| XAS-XES Steady-State and Time-Resolved X-ray Absorption and Emission Spectroscopy | A15 |
| Macromolecular Crystallography Group | A19 |
| MASSIF Massively Automated Sample Screening Integrated Facility | A20 |
| MX-BIB Biological Imaging Beamline | A22 |
| MX-MAD1 and MX-MicroFocus Macromolecular Crystallography using Multi-Wavelength Anomalous Dispersion and Microfocus | A24 |
| MX-MAD2 Macromolecular Crystallography using Multi-Wavelength Anomalous Dispersion with Microfocus | A26 |
| Materials Science Group | A28 |
| EMS Engineering Materials Science | A29 |
| HIENE High Energy X-ray Beamline | A31 |
| HIPRE High Pressure Technique Beamlines | A33 |
| MATSCI Materials Science | A39 |
| POW High Resolution Powder Diffraction | A42 |
| TRD Time-Resolved Diffraction and Pump-and-Probe | A45 |
| Soft Condensed Matter Group | A49 |
| GISD Grazing Incidence Scattering and Diffraction | A50 |
| HISAXS High Throughput Small Angle X-ray Scattering | A54 |
| MINADIF Micro- and Nano-Diffraction | A55 |
| SAXS Small Angle X-ray Scattering | A60 |
| XPCS-CXS X-ray Photon Correlation Spectroscopy and Coherent X-ray Scattering | A63 |

| | | |
|--|---|-------------|
| Surface and Interface Science Group | | A67 |
| CDI | Coherent Diffraction Imaging and Microdiffraction | A68 |
| HXPM | Hard X-ray Photoelectron Microscopy | A72 |
| SURF | Surface Diffraction | A74 |
| Technical Beamline Support Group | | A77 |
| OPTICS | Facility for Surfacing Mirror Substrates | A78 |
| TIBIDI | Technical Beamline for Instrumentation Development | A79 |
| WIBIDI | White Beam Technical Development Beamline | A81 |
| X-ray Absorption and Magnetic Scattering Group | | A82 |
| DICHRO | Polarisation Dependent X-ray Spectroscopy | A83 |
| EDXAS-S | Energy Dispersive Absorption Spectroscopy (small spot) | |
| EDXAS-L | Energy Dispersive Absorption Spectroscopy (large spot) | A87 |
| EXAFS | Extended X-ray Absorption Fine Structure Spectroscopy | A92 |
| MAGSCAT | Magnetic Scattering | A96 |
| PMF | Pulsed Magnetic Fields | A99 |
| RIXS-PES | High Resolution Resonant Inelastic X-ray Scattering and Photoelectron Spectroscopy | A103 |
| SMS | Resonant Soft X-ray Magnetic Scattering | A106 |
| X-ray Imaging Group | | A110 |
| CPR | Development of Clinical Protocols in Radiotherapy | A111 |
| IMPACT | Imaging using Parallel Beam and Computed Tomography | A116 |
| SFINX | Scanning Fluorescence and Imaging at the Nanoscale using X-rays | A119 |
| SMILE | Spectro-Microscopy and Imaging at Low Energies and XMAN: X-ray Spectroscopy Multi-Imaging Analysis | A121 |
| ANNEXE II - SAFETY | | A127 |
| Safety considerations for operation at 300 mA stored current | | A128 |
| ANNEXE III - OTHER SYNCHROTRONS | | A131 |
| III.1. Other European synchrotron facilities | | A132 |
| III.2. Worldwide sources comparable to the ESRF | | A137 |
| ANNEXE IV - ESRF FACTS AND FIGURES | | A139 |
| IV.1. ESRF annual budget | | A140 |
| IV.2. Staff | | A140 |
| IV.3. The beamlines | | A140 |
| IV.4. User operation | | A143 |
| IV.5. The source | | A143 |
| GLOSSARY AND CONTRIBUTORS | | A145 |



The European Light Source

ESRF SCIENCE AND TECHNOLOGY PROGRAMME 2008-2017

ANNEXE I

Conceptual Design Reports

Introduction to the Conceptual Design Reports of the High Resolution and Resonance Scattering Group

The beamlines of the Group are, ultimately, dependent on an outstanding performance of the accelerator and source in terms of brilliance, stability, spectral flux and timing properties.

The aim of the CDRs proposed by this Group are, on the one hand, a drastic performance improvement in terms of throughput and energy resolution resulting in a new quality of research (INELX, NR-HE, PHIXS, XAS-XES) and, on the other hand, the exploration of new research areas (XAS-XES, NR-NSM, INELX). They are very closely linked to the priority areas highlighted by the ESRF Scientific Advisory Committee, *Science at Extreme Conditions* (INELX, NR-HE, NR-NSM, PHIXS, XAS-XES), *Nanoscience and Nanotechnology* (INELX, NR-HE, NR-NSM, PHIXS), and *Pump-and-Probe and Time-Resolved Science* (XAS-XES). The following ideas could only be implemented within the context of the Upgrade Programme: (a) The combination of the proposed high magnetic field project and the Group's

spectroscopic techniques (all projects) would open new avenues (all projects); (b) the access to the sub-meV regime of energy transfer would open *e.g.* a new window for the study of acoustic excitations in liquids and glasses not accessible by any other technique (INELX); (c) the approach to study nanoscale objects simultaneously with nuclear resonant scattering and various complementary techniques would offer a new quality in research (NR-NSM), (d) pump-and-probe spectroscopy (XAS-XES) to open up a new realm of research to study electronic and structural changes.

The Group's CDRs very much rely on infrastructure in the fields of optics for high-resolution monochromatisation and focusing (all projects), very fast position sensitive detectors (INELX, NR-HE, NR-NSM) as well as high pressure techniques and instrumentation and sample environment in general. Partnerships in surface science, high magnetic fields, soft condensed matter and materials science would be welcome.

Summary of individual CDRs

| | | |
|----------------|--|---------|
| INELX | Inelastic X-ray Scattering: Evolution of the two stations (a) high energy resolution IXS and (b) resonant and non-resonant IXS and XES to sub-meV and sub-eV resolution, respectively, with an increased overall throughput. | page 5 |
| NR-HE | Nuclear Resonance – High Energy: A new station for NRS applications addressing high energies with an emphasis on extreme conditions of high magnetic (static and pulsed) field and high pressure in combination with low and high temperature. | page 6 |
| NR-NSM | Nuclear Resonance – Nanoscale Materials: A global environment for the study of nanoscale materials addressing the interplay of growth, structure, electric and magnetic properties, as well as dynamics. | page 9 |
| PHIXS | Phonon Inelastic X-ray Spectroscopy: An upgrade to enhance the productivity of phonon spectroscopy by a factor of ten and new data taking strategies for (textured) polycrystalline materials with the aim of extracting single crystal properties. | page 12 |
| XAS-XES | Steady-State and Time-Resolved X-ray Absorption and Emission Spectroscopy: A new station for time-resolved absorption and emission spectroscopy on dilute systems in pump-and-probe mode to complement the upgrade for resonant and non-resonant emission spectroscopy. | page 15 |

INELX: Inelastic X-ray Scattering

Summary

Beamline ID16 currently consists of two stations for Inelastic X-ray Scattering (IXS) experiments that can be operated alternately. Station 1 is dedicated to the study of high frequency acoustic dynamics requiring energy resolutions in the meV range whilst station 2 is dedicated to the study of the electronic excitations requiring high beam intensities and resolutions in the eV range. Station 1 shares similarities with the current ID28: while the latter however, is optimised for studies of crystalline systems, the former is optimised for studies of liquids and glasses. Station 2 shares similarities with the current ID26: while the latter however is optimised for absorption and emission experiments, the former is optimised for scattering experiments.

In order to keep ID16 at the forefront of the IXS technique and at the cutting edge of the current scientific challenges, proposals are made for the upgrade of both stations of the beamline. These upgrades will not only give further strength to the current very active research programme, but will open new scientific opportunities.

Scientific case

Overview

The scientific case for IXS currently includes the following research areas:

- Study of the high energy ($E \geq 1.5$ meV) acoustic excitations in disordered systems (Sette *et al.*, 1998);
- Study of the interplay of electron correlation and band structure effects in condensed matter (Sternemann *et al.*, 2005);
- Study of the electronic structure and spin states of transition metal and rare earth compounds (Dallera *et al.*, 2002; Badro *et al.*, 2004).

The proposed beamline upgrade will unlock new scientific opportunities. Three examples can be mentioned here:

- Study of the acoustic excitations of liquids and glasses in the sub-meV energy range, which has been recently suggested to be of key relevance for the physics of disordered systems (Rufflé *et al.*, 2006). This range is currently not accessible to IXS nor to any other experimental technique and it is even out of range for modern molecular dynamics simulations which cannot deal with the required box sizes.
- Study of the wave number and polarisation dependence of the weak eV and sub-eV electronic excitations in correlated electron materials, which are considered to be of key importance to understand the

peculiar properties of these materials (Collart *et al.*, 2006). Whilst resonant IXS experiments at the copper K-edge are currently feasible, the upgrades would extend this field of research to the K-edges of other transition metals, starting from nickel and cobalt.

- Study of the electronic structure around low-Z atoms (including carbon, nitrogen and oxygen) in materials subjected to conditions (temperature, pressure) not compatible with standard soft X-rays and electron spectroscopy. In fact by using Raman IXS, it is possible to obtain information equivalent to that accessible by X-ray absorption but with the advantages of hard X-rays (Mao *et al.*, 2005).

Techniques

Station 1 is fully dedicated to high energy resolution IXS experiments. Station 2 offers a multi-purpose space where an appropriately conditioned X-ray beam (energy resolution, divergence) can be exploited to perform different experiments using various setups. The techniques used at Station 2 include resonant and non-resonant IXS, coherent IXS, resonant and non-resonant X-ray emission and high-energy (6 to 10 keV) photoemission.

The upgrade programme for these two stations will be focused on the following points:

- Optimise the available setups to reach a higher energy resolution (sub-meV for station 1 and sub-eV for station 2) and a higher contrast (the latter development for station 1 requires a long beamline, see below);
- Improve the focusing optics to reach a focal spot at the sample stage down to the 1 to 10 μm range;
- Increase the overall throughput of the spectrometers by increasing the number of available analysers.

Context with new sources and user community

Set ups for IXS experiments with meV energy resolutions are for the time being only competitive at hard X-ray synchrotron sources (ESRF, APS and SPRING8). The situation is different concerning eV and sub-eV energy resolution experiments to study electronic excitations: several beamlines at the new third-generation sources will appear in the coming years that are able to perform this kind of experiment at a competitive level.

User interest in IXS is demonstrated by the high subscription ratio of the beamline (an average oversubscription ratio of three over the period 2000 to 2006) and will surely increase once the beamline has been upgraded.

Technical considerations

Station 1. The development of this station will proceed along several lines, most of which are identical to those concerning the proposed upgrade of ID28:

- An energy resolution of 1 meV will be achieved exploiting the Si(13,13,13) reflection for both monochromator and analysers and will require a full optimisation of the available setup in terms of source and optics. In addition, a new optical scheme has recently been proposed to achieve sub-meV energy resolutions (Shvyd'ko *et al.*, 2006). Whilst this scheme still represents a challenge in X-ray optics, a complete feasibility study is currently underway.
- The focusing scheme of the beamline will be improved (new ellipsoidal mirror to be installed at 2 to 3 m from the sample), aiming at a $20 \times 5 \mu\text{m}^2$ (H x V) focal spot, generally compatible with extreme condition sample environments.
- In order to increase the throughput of the station, the number of analysers available today (five) in the spectrometer will need to be increased to allow for a complete investigation of the first pseudo-Brillouin zone of a typical disordered system ($\sim 20 \text{ nm}^{-1}$) with one spectrometer setting.

Station 2. The development of this station will also proceed along several lines:

- Improve the energy resolution available for the experiments by adding a four bounce monochromator.
- Improve the focusing scheme adding toroidal and Kirkpatrick-Baez mirrors in order to achieve a focal spot of $\sim 1 \mu\text{m}$ at the sample stage.
- Add the possibility of selecting the polarisation of the incoming beam using a diamond phase plate.
- Upgrade the spectrometer adding a multi-analyser setup optimised for non-resonant IXS experiments (work along this line is currently in progress).

Moreover, recent advances in position sensitive pixel detectors can nowadays be efficiently exploited to improve the performance of IXS spectrometers. This is particularly true for high energy resolution resonant IXS spectrometers (Huotari *et al.*, 2006) and this concept will be exploited in the upgraded version of station 2.

Station 3 (long beamline). High resolution IXS experiments in disordered systems are often limited by the contrast achievable by the available spectrometers. In order to overcome this problem, a possible scenario is to exchange the existing back scattering monochromator with an in-line one and, at the same time, to build a spectrometer where the energy analysis of the scattered photons is based on a double-pass scheme through two analysers placed on two 7 m radius Rowland circles intersecting at the sample position. The implementation of this scheme requires a hutch of about 16 to 20 m transversal size. Taking into account the space constraints within the ring, this development can only take place at distances of at least 150 m from the source.

References

- Badro J., Rueff J.P., Vankó G., Monaco G., Fiquet G., and Guyot F. (2004), Electronic transitions in perovskite: possible non-convecting layers in the lowermost mantle, *Science*, **305**, 383-386.
- Collart E., Shukla A., Rueff J.P., Leininger P., Ishii M., Jarrige I., Cai Y.Q., Cheong S.W., and Dhahenne G. (2006), Localized and delocalized excitons: resonant inelastic x-ray scattering in $\text{La}_{2-x}\text{Sr}_x\text{NiO}_4$ and $\text{La}_{2-x}\text{Sr}_x\text{CuO}_4$, *Phys. Rev. Lett.*, **96**, 157004.
- Dallera C., Grioni M., Shukla A., Vankó G., Sarrao J. L., Rueff J.P., and Cox D.L. (2002), New spectroscopy solves an old puzzle: the Kondo scale in heavy fermions. *Phys. Rev. Lett.*, **88**, 196403.
- Huotari S., Albergamo F., Vankó G., Verbeni R., and Monaco G. (2006), Resonant inelastic hard x-ray scattering with diced analyzer crystals and position-sensitive detectors, *Rev. Sci. Instr.*, **77**, 053102.
- Mao W.L., Peter J., Thomas P., Newville M., Kao C.C., Dion L., Jinfu S.-H., Meng Y., and Hemley R.J. (2003), Bonding changes in compressed superhard graphite, *Science*, **302**, 425-427.
- Rufflé B., Guimbretière G., Courtens E., Vacher R., and Monaco G. (2006), Glass-specific behaviour in the damping of acoustic-like vibrations, *Phys. Rev. Lett.*, **96**, 045502.
- Sternemann, C., Huotari S., Vankó G., Volmer M., Monaco G., Gusarov A., Lustfeld H., Sturm K., and Schülke W. (2005), Correlation-induced double-plasmon excitation in simple metals studied by inelastic x-ray scattering, *Phys. Rev. Lett.*, **95**, 157401.
- Sette F., Krisch M.H., Masciovecchio C., Ruocco G., and Monaco G. (1998), Dynamics of glasses and glass-forming liquids studied by inelastic x-ray scattering, *Science*, **280**, 1550-1555.
- Shvyd'ko Y.V., Lerche M., Kuetgens U., Rüter H. D., Alatas A., and Zhao J. (2006), X-ray Bragg diffraction in asymmetric backscattering geometry, *Phys. Rev. Lett.*, **97**, 235502.

NR-HE: Nuclear Resonance - High Energy

Summary

The Nuclear Resonance Group is currently operating two stations, ID18 and ID22N, for the application of nuclear resonance techniques in order to offer state-of-the-art experimental environments for various techniques and to cope with the ever growing demand of the user community. ID18 is entirely devoted to nuclear resonance applications and offers the most versatile and effective X-ray optics and experimental environments, so that the entire range of Mössbauer isotopes can be investigated. ID22N is most efficient at energies above 21.5 keV due to the requirements of the hosting beamline ID22 and is operated in 16-bunch mode only.

The stations provide access to various nuclear resonance techniques in order to conduct experiments on slow and fast dynamics and on electronic or magnetic properties ranging from solid state physics and geo-sciences to biology and medicine. The leading role of these stations is ensured through continuous upgrades. Scientifically, special emphasis is given to investigations under extreme conditions and on nanoscale materials. Whereas the field of nanoscale materials is the topic of the CDR NR-NSM, the project presented here will strengthen the field of extreme conditions with special emphasis on high energies.

The aim of this project is to construct an experimental station dedicated to nuclear resonance applications at high photon energies (20 to 100 keV). Applications comprise the determination of magnetic and electronic properties as well as of slow and fast dynamics with emphasis on extreme conditions such as high pressure, high magnetic field and high or low temperatures. The station will explore nuclear resonance techniques above 30 keV and take those in the 20 to 30 keV range to maturity.

Scientific case

Overview

Nuclear resonance techniques have been established with the advent of third-generation synchrotron radiation sources, at the ESRF, APS, and SPRING-8, as a novel spectroscopic tool for the determination of magnetic and electronic properties and of slow and fast dynamics under extreme conditions. Special attention has been given to nanostructured materials and thin films linked intimately to nanotechnology and to high pressure investigations at low and high temperatures.

To date, most experiments have been carried out on the isotope ^{57}Fe . However, in recent years, Mössbauer isotopes having resonances in the 20 to 30 keV regime (*e.g.* Eu (Long *et al.*, 2005); Sm (Barla *et al.*, 2004), Dy (Chumakov *et al.*, 2001), Sn (Barla *et al.*, 2005) and I) have been increasingly used. Resonances at higher energies have been used only occasionally, due to the lack of efficient X-ray optics and of the insufficient brilliance of the available synchrotron sources. This is most unfortunate, as there are many interesting Mössbauer isotopes with transition energies in the energy range 30 to 100 keV. Amongst them ^{61}Ni (67 keV) stands out, due to its importance for biological and solid-state applications. Furthermore, several rare earth elements (Nd, Gd, Er and Yb and the actinide Np) have Mössbauer resonances in this range that are otherwise not accessible. With ^{73}Ge (69 keV) an important isotope for semiconductor research would become available. As examples, we will discuss the following three cases.

Strongly correlated electron systems (SCES): The study of SCES is the foremost area of research in contemporary condensed matter physics. The challenge is double: the correlations are very difficult to deal with theoretically and experimental studies require extreme conditions (very low temperatures combined with high pressure and/or high magnetic fields). The interplay and competition between spin, orbital, and charge order in these materials was shown to lead to a rich variety of behaviour. Besides the traditional branches of SCES, such as the non-magnetic Kondo many body singlet, valence fluctuations or heavy fermions, new topics have emerged over the years. Amongst them some are mentioned here where nuclear resonance techniques may contribute due to Mössbauer active isotopes: Kondo insulators as SmS, SmSe, SmTe, SmB_{6i} ; heavy fermions systems as $\text{U}(\text{X}_{1-x}\text{Y}_x)_3$, with $\text{X} \in \text{IIIA}$, $\text{Y} \in \text{IVA}$.

Nickel case: Nickel is one of the most interesting metal elements for functional biology. It can serve as a metal centre in enzymes. Whereas there exist a huge variety of studies on iron centres with Mössbauer spectroscopy there is nearly nothing reported for nickel. This is mainly due to the characteristics of the isotope ^{61}Ni itself and the corresponding Mössbauer source, which are inconvenient. Nuclear forward scattering as the time analogue of Mössbauer spectroscopy combined with synchrotron radiation based perturbed angular correlation would overcome those problems. Especially the latter, as an elastic and incoherent method gives access to the entire temperature regime important for biological systems. Combined with nuclear inelastic scattering as a complementary inelastic and incoherent technique the phonon density of states (DOS) is accessible.

In solid state applications nickel plays a role in strongly correlated electron systems as well as in new applications of nanoscale materials. Examples of nickel containing SCES are RNiO_3 (*R*- rare-earths), NiS and $\text{La}_{2-x}\text{Sr}_x\text{NiO}_4$. The RNiO_3 compounds are particularly interesting from the experimental point of view because most of the rare earth elements have Mössbauer active isotopes. This allows one to investigate the two metal sites separately.

Germanium case: Germanium (^{73}Ge) is the only classical elementary semiconductor that has a Mössbauer active isotope. For compound semiconductors other elements with suitable isotopes are Sb, Te and Sn (Zn being too difficult).

During the past years, semiconductor nanostructures have been investigated extensively in order to study the effect of quantum confinement on the physical properties. Nano-structures of group IV elements embedded in a dielectric layer can emit light and store carriers suggesting future applications in optoelectronics and non-volatile memory devices. Furthermore, the so called GST (Ge-Sb-Te) compounds are still a contemporary field of interest. Here,

germanium again became an important element and tremendous effort has been invested in, for example, germanium quantum dots. Nuclear resonance techniques could contribute to the field of electronic and maybe magnetic properties as well as dynamics, with the latter becoming more important at nanoscale sizes. (Self-)diffusion and vibrational density of states would be accessible.

Techniques

Nuclear Forward Scattering (NFS)

NFS is an elastic and coherent scattering technique in the forward direction. It is sensitive to magnetic and electronic properties as well as slow dynamics (translational and rotational). Experimentally it is well suited in combination with big sample environments necessitating only small entrance and exit windows due to the forward scattering geometry. Reasonable Lamb-Mössbauer factors (LMF) are mandatory, which is still the case for the 20 to 30 keV regime. At higher energies, however, the LMF becomes smaller and smaller and keeping the sample at cryogenic temperatures is an imperative.

Synchrotron Radiation based Perturbed Angular Correlation (SRPAC)

SRPAC is an elastic and incoherent scattering technique with emission in 4π . Consequently it is not sensitive to the LMF and to translational dynamics. It is therefore well suited for Mössbauer isotopes with high transition energies and negligible LMF. As is the case for NFS, it probes the magnetic and electronic properties as well as rotational dynamics. The combination of SRPAC with NFS may be used to separate the translational and rotational dynamics.

Nuclear Inelastic Scattering (NIS)

NIS is an inelastic and incoherent scattering technique probing the partial density of phonon states. There is no need for single crystals and due to the incoherent scattering character, there is a perfect integration over momentum space. However, above 30 keV no efficient high resolution monochromators are available so that new avenues have to be explored.

Context with new sources and user community

Currently, nuclear resonance stations are operated at the three third-generation synchrotron radiation sources for hard X-rays: APS, ESRF and SPRING-8. At other sources the brilliance is not high enough at the energies of the Mössbauer transition energies. A nuclear resonance beamline at the upcoming PETRA-III storage ring has been proposed; however, for the time being the decision is pending. Amongst the others, being the smallest machine (6 GeV), the brilliance at the ESRF

cannot compete with those of the other rings operated at 7 and 8 GeV, respectively. This fact has to be compensated by intelligent X-ray optics and innovative and flexible sample environments. This proposal continues in this spirit and offers the access to high energies with applications under extreme conditions.

Technical considerations

Most technical considerations concerning the X-ray source, optics, and the detectors are identical for the two nuclear resonance proposals, NR-NSM and NR-HE. However, whilst for the NR-NSM beamline the infrastructure is mainly available, it has to be created for this project. We envisage two hutches for high resolution monochromators and two experimental hutches, one for the existing sample environment and one for the new application at very high magnetic fields.

Source: Timing modes are required for nuclear resonance applications. Currently the 4- and 16-bunch modes are the most efficient filling patterns of the storage ring. However, if the limitation to an electron current of 90 mA could be overcome, the spectroscopy would gain. For some applications (*e.g.* nuclear inelastic scattering) the hybrid mode with 200 mA is suited as well.

Presently short period "revolver" type undulators operated in the fundamental and the third harmonics (21.5 keV and higher) give the best trade off between heat load, *i.e.* stability of the optics and flux on the sample. For high energies a cryogenically cooled in-vacuum undulator or a super-conducting undulator might be more beneficial.

High heat load monochromator: Nuclear resonance applications are utilising Mössbauer transitions with fixed energies. The present design, based on two independent Si (111) crystals, has proved to be most stable and is able to sustain heat loads higher than 1 kW (Internal ESRF Report). In combination with collimating compound refractive lenses (CRL) upstream of the monochromator, the divergence of the synchrotron radiation even at high energies is matched to the vertical angular acceptance of the crystals, thereby maximising the throughput.

High resolution monochromators (HRM): HRMs with (sub-)meV energy resolution have only a limited tuning range, *i.e.* for each Mössbauer transition energy, HRMs optimised for energy resolution and flux, respectively, have to be available. For energies below ~30 keV state-of-the-art monochromators consist of four bounce arrangements with combined dispersive and non-dispersive settings allowing in-line geometry. Due to heat load issues, cryogenically cooled systems may become necessary in the future. In order to optimise the throughput, collimating CRLs are mandatory.

In general, above 30 keV new schemes have to be explored. For some energies the standard four bounce monochromators may work, which has to be investigated case by case. Another solution is a true back scattering monochromator as is frequently used in inelastic X-ray scattering. However, the generally used silicon crystals are no longer appropriate for high energy Mössbauer transitions because there are no suitable reflections available. In order to obtain more reflections, a less symmetric crystal structure is necessary (for example sapphire). In that case reflections for back scattering are in reach for all Mössbauer transitions (Shvyd'ko, 2004). The first attempts in that direction have been carried out already in our group (Wille *et al.*, 2006). Furthermore, for NFS and SRPAC applications a more relaxed energy resolution might be acceptable (Sergueev *et al.*, 2007), which might simplify the monochromator design. In these cases also, collimating CRLs are mandatory.

For the "standard" four bounce HRM an independent temperature stabilised hutch is mandatory with at least two HRMs for different energies allowing fast switching during user operation. For the setup of the back scattering monochromator a suitable hutch at the end of the beamline is mandatory. Generally, temperature stabilisation of the hutch to 0.1 to 0.01 K is required as well as vibration stability.

Focusing: Existing focusing schemes use Kirkpatrick-Baez (KB) optics based on multilayers and accept the entire beam, mandatory for nuclear resonance applications. Implementing the proposed station downstream of the IXS station (see proposal PHIXS) at a source distance of around 100 m, a focal spot size of $1 \mu\text{m} \times 10 \mu\text{m}$ should be attainable, which would be beneficial for the envisaged applications.

Experimental stations: The existing capabilities of the beamline should remain comprising a cryomagnet system (8 T, 1.5 to 300 K, high pressure) and a setup with flow-cryostat and furnace. This experiment would need a dedicated experimental hutch (5 m high) with the experimental environment recovered from the existing one. In order to house the very high magnetic field environment a second experimental hutch is needed including infrastructure. In summary, two experimental hutches are needed.

Detectors: Nuclear resonance scattering is a time-resolved technique, which needs a time resolution in the 100 ps (limited by the synchrotron radiation pulse) to nanosecond regime. State-of-the-art detectors (developed in the group) based on avalanche photo diodes (APD) and fast electronics reach 0.75 to 1 ns time resolution. Efficiencies are reasonable for energies up to ~30 keV. The various nuclear resonance techniques demand various detector schemes. Future scientific challenges demand a development of 1D and 2D detectors. First attempts with a 1D detector and

0.2 ns time resolution has just been carried out allowing magnetic small-angle scattering to visualise the dynamics of magnetic domains. Furthermore, in order to access Mössbauer isotopes with high transition energies (> 30 keV) further developments have to be initiated.

Support facilities

The proposal would benefit from the envisaged facilities, especially the development of fast detectors and high pressure and high magnetic field facilities.

References

- Barla A., Sanchez J.P., Haga Y., Lapertot G., Doyle B.P., Leupold O., Ruffer R., Abd-Elmeguid M., Lengsdorf R., and Flouquet J. (2004), Pressure-Induced Magnetic Order in Golden SmS, *Phys. Rev. Lett.*, **92**, 066401.
- Barla A., Sanchez J.P., Aksungur A., Lengsdorf R., Plessel J., Doyle B.P., Ruffer R., Takabatake T., Abd-Elmeguid M.M. (2005), Pressure driven collapse of the magnetism in the Kondo insulator UNiSn, *Phys. Rev. B*, **71**, 020402(R).
- Chumakov A.I., Ruffer R., Leupold O., Barla A., Thies H., Gil J.M., Alberto H.V., Vilão R.C., Ayres de Campos N., Kohn V.G., Gerken M., and Lucht M. (2001), Nuclear inelastic scattering with ^{161}Dy , *Phys. Rev. B*, **63**, 172301.
- Long G.J., Hermann R., Grandjean F., Alp E., Sturhahn W., Johnson E., Brown E., Leupold O., Ruffer R. (2005), Strongly decoupled europium and iron vibrational modes in filled skutterudites, *Phys. Rev. B*, **71**, 140302.
- Sergueev I., Chumakov A.I., Deschaux Beaume-Dang T.H., Ruffer R., Strohm C., and van Bürck U. (2007), Nuclear forward scattering for high energy Mössbauer transitions, *Phys. Rev. Lett.*, **99**, 097601.
- Shvyd'ko Y., X-ray optics, Springer series in optical sciences **98**, 2004.
- Wille H.-C., Shvyd'ko Y.V., Alp E.E., Rüter H.D., Leupold O., Sergueev I., Ruffer R., Barla A., and Sanchez J.P. (2006), Nuclear resonant forward scattering of synchrotron radiation from ^{121}Sb at 37.13keV, *Europhys. Lett.*, **74**, 170-176.

NR-NSM: Nuclear Resonance - Nanoscale Materials

Summary

The Nuclear Resonance Group is currently operating two stations, ID18 and ID22N, where nuclear resonance techniques are combined with state-of-the-art experimental environments. ID18 is entirely devoted to nuclear resonance applications and offers the most versatile and demanding X-ray optics and experimental environments for the entire range of Mössbauer isotopes. ID22N is most efficient at energies above 21.5 keV, due to the requirements of the hosting

beamline ID22. Furthermore, this station is only running in 16-bunch mode.

The nuclear resonance stations provide access to various nuclear resonance techniques in order to conduct experiments on slow/fast dynamics and electronic/magnetic properties ranging from solid state physics, geo-science to biology and medicine. A continuous upgrade programme ensures the leading role of the beamline. Special emphasis is given to investigations under extreme conditions and of nanoscale materials. With this project we intend to strengthen these applications in order to retain our leading position in this field. The other project, High Energy Nuclear Resonance (NR-HE), focuses more on high energies and extreme conditions as high pressure and high magnetic fields.

The project, described in this document aims at a symbiosis of state-of-the-art surface science techniques and nuclear resonance techniques for studies of the growth (*in situ*), dynamics (phonons, diffusion) and electronic/magnetic properties of nanoscale materials.

Scientific case

Overview

Dynamical properties of condensed matter are of paramount importance for the functionality of future nanoscale devices. The role of the interfaces between adjacent materials becomes increasingly relevant with decreasing size of the structural units, and novel dynamical phenomena are expected in these nanostructures. Since the properties of low dimensional structures are significantly different from those of corresponding bulk materials, new methods have to be developed for the experimental characterisation and theoretical modelling. An efficient way to achieve this is to use the extremely brilliant X-rays provided by modern synchrotron radiation sources such as the European Synchrotron Radiation Facility (ESRF) to study dynamical properties *in situ* under ultrahigh vacuum (UHV) conditions. Nuclear resonant scattering of synchrotron radiation is particularly well suited for the study of vibrational properties, diffusion and growth, and magnetic processes, due to its high spatial and temporal resolution.

The overall objective of this project is to increase the basic understanding of dynamic and magnetic phenomena and in particular of their size dependence in nanostructures. The combination of nuclear resonant scattering experiments with advanced surface sensitive experimental and computational methods yields detailed insights into the following areas:

- The modification of collective excitations like phonons by interfaces and boundaries in thin films,

multilayers, and nanoparticles including nanowires and nanodots.

- The role of diffusion in the kinetics of structural changes that occur during processing of materials or the growth of thin films.
- The dynamical magnetic properties of nanostructures, the evolution of magnetic properties during growth and the interlayer coupling of magnetic layers, as they determine the fast magnetisation reversal and the ultimate magnetic storage density.

In order to achieve this goal a dedicated experimental environment has to be implemented, which combines UHV conditions and surface science characterisation tools with *in situ* nuclear resonant scattering and micro-/nano-focusing capabilities.

Techniques

Determination of dynamical properties

The dynamical properties of nanoscale objects become more and more important as the particle size decreases. In magnetism this is witnessed in the phenomena of superparamagnetism. In structural dynamics the vibrational properties and diffusivity change as the size of the system is reduced below 1 μm . Two nuclear resonance techniques may contribute to such investigations: nuclear inelastic scattering (NIS) and grazing incidence NRS (GINRS).

NIS measures the partial density of phonon states of the Mössbauer isotope. The scattering is incoherent scattering. The measured signal is therefore perfectly integrated over momentum space and there is no need for single crystal samples. Applications to nanocrystalline materials, *e.g.* iron are straight forward (Pasquini *et al.*, 2002), even the investigation of a monolayer of iron on a surface (Stankov *et al.*, 2006) has been reported. With the probe layer technique buried layers/interfaces can be accessed with atomic resolution.

GINRS as a variant of nuclear forward scattering (NFS) is available for the study of slow dynamics, *e.g.* diffusion, with atomic resolution. Diffusivities in the range of 10^{-12} to 10^{-14} m^2/s are accessible via the accelerated decay of the NFS signal (Sepiol *et al.*, 1996). Furthermore, the isotopic multilayer technique can be applied for the range of 10^{-26} to 10^{-18} m^2/s (Gupta *et al.*, 2005).

Determination of magnetic and electronic properties

GINRS is perfectly suited for investigations of electronic and magnetic properties of thin films, surfaces/interfaces and nanostructures. With the probe layer technique atomic resolution in thin films or layered structures is routinely achieved, *e.g.* in a detailed study of the spin structure of iron on FePt (Röhlsberger *et al.*, 2002). Combining this approach with micro-/nano-focusing capabilities, single nanowires or nanostructures could be tackled.

Determination of magnetic structures

Nuclear resonance techniques are sensitive to magnetic properties of materials. Combining these techniques with classical small angle scattering, magnetic structures and their dynamics can be probed. The first results have been reported on the domain growth of Fe/Cr multilayers after magnetisation reversal (Nagy *et al.*, 2002).

A newly developed 16 element 1D fast detector system (Deschaux-Baume *et al.*, 2006) has greatly facilitated such investigations. Further developments of 1D or 2D detector systems, accessing the entire relevant Q-space, with nanosecond time resolution would make the investigation of time-resolved magnetisation dynamics feasible.

Determination of structural properties

Besides the nuclear resonance based techniques, standard X-ray techniques such as surface diffraction and GI-SAXS would simultaneously become available. Laboratory based techniques as LEED, RHEED and microscopy are mandatory and should complement, preferably as *in situ* tools, the synchrotron radiation based techniques.

Context with new sources and user community

Currently, nuclear resonance stations are operated at the three third-generation synchrotron radiation sources for hard X-rays: APS, ESRF and SPRING-8. Sources operating at lower energy cannot provide the necessary brilliance at the energies of the Mössbauer transitions. A nuclear resonance beamline at the upcoming PETRA-III storage ring has been proposed, however, for the time being the decision is pending. Compared to the APS and SPRING-8, the ESRF is the lowest energy machine (6 GeV), the brilliance at the ESRF cannot compete with those of the other rings operated at 7 and 8 GeV, respectively. This fact has to be compensated by intelligent design of the X-ray optics, and innovative and flexible sample environments. This proposal continues in this spirit and offers a novel area in the study of nanoscale materials.

Our user community has pioneered the field and laid the basis in the framework of the European FP6 programme (DYNASYNC) for the study of nanoscale materials under UHV conditions.

Technical considerations

Most of the considerations concerning the X-ray source, the optics and the detectors are identical for the two proposals, NR-NSM and NR-HE.

Source: Timing modes are required for nuclear resonance applications. Currently the 4- and 16-bunch modes are the most efficient filling patterns. However, if the limitation to an electron current of 90 mA could be overcome, the spectroscopy applications would gain. For some applications (*e.g.* nuclear inelastic scattering) the hybrid mode with 200 mA is also well suited.

Presently short period "revolver" type undulators operated in the fundamental and the third harmonics (21.5 keV and above) give the best trade off between heat load, *i.e.* stability of the optics and flux on the sample. In general, pushing the operation of the undulator always to the fundamental harmonic would be an asset.

High heat load monochromator: Nuclear resonance applications use Mössbauer transitions with fixed energies. The present design, based on two independent Si(111) crystals, has proved to be most stable and able to sustain heat loads higher than 1 kW (Internal ESRF Report). In combination with collimating compound refractive lenses (CRL) upstream of the monochromator, the divergence of the synchrotron radiation even at high energies can be matched to the vertical angular acceptance of the crystals, thus maximising the throughput.

High resolution monochromators (HRM): HRMs with (sub-)meV energy resolution have only a limited tuning range, *i.e.* for each Mössbauer transition energy, HRMs optimised for energy resolution and flux, respectively, have to be available. For energies below ~30 keV state-of-the-art monochromators are four bounce arrangements with combined dispersive and non-dispersive settings allowing in-line geometry. Due to heat load issues, cryogenically cooled systems may become necessary in the future. In order to optimise the throughput, collimating CRLs are mandatory. Above 30 keV new schemes have to be explored, as discussed in the framework of the proposal HE-NR. Generally, temperature stabilisation of the hutch to 0.1 to 0.01 K is required as well as vibration stability.

Focusing: Existing focusing schemes use KB optics based on multilayers and achieved a focal spot of $5 \mu\text{m} \times 20 \mu\text{m}$ (vertical \times horizontal). They accept the entire X-ray beam, mandatory for nuclear resonance applications, and have a reflectivity in the order of 40 to 80%. The focal spot size was reached with a demagnification ratio of 50, determined by geometry: 1 m focal length (sample environment) and 50 m source distance (maximum length of the beamline). The $20 \mu\text{m}$ horizontal spot size is determined solely by the demagnification ratio, whereas, in the vertical, 0.5 to $1 \mu\text{m}$ should be attainable. The mismatch is probably given by the performance of the optics (prototype). In this project we envisage nanometre focusing capabilities. This can only be achieved by improving the demagnification ratio. On a first approximation it

goes with the distance source to optics (keeping a focal length of 1 m), *i.e.* going to 250 m we would obtain $0.1 \mu\text{m} \times 4 \mu\text{m}$ (vertical \times horizontal). This is certainly a challenging undertaking, however, the experience of the two new long pilot beamlines (ID11, CDR MATSCI, and ID13, CDR MINADIF) presently under commissioning will demonstrate the technology and future directions.

Experimental stations: The existing capabilities of the beamline should be maintained. They comprise a diffractometer, cryomagnet system (6 T, 1.5 to 300 K, high pressure), a setup with a flow-cryostat and a furnace. The existing UHV environment should be upgraded and the final station should comprise:

- Deposition capabilities: MBE (molecular beam epitaxy), sputter and cluster source;
- *In situ* characterisation tools: LEED (low energy electron diffraction), REED (reflection high energy electron diffraction), ellipsometry;
- Characterisation tools: MOKE (magneto-optical Kerr effect), STM/AFM;
- Complementary techniques: infrared and Raman spectroscopy.

In order to achieve sub-micrometre focusing a new experimental hutch has to be implemented at a distance of 250 m from the source point. The experimental hutch should host the focusing optics and the basic UHV environment for nuclear resonance applications. Adjacent to this safety hutch a laboratory for the other equipment (see above) has to be setup with a common UHV environment to allow for easy and fast transfer of samples under UHV conditions.

Detectors: Nuclear resonance scattering is a time-resolved technique, which needs a time resolution in the 100 ps (limited by the synchrotron radiation pulse) to the nanosecond regime. State-of-the-art detectors (developed in the group) based on avalanche photo diodes (APD) and fast electronics reach 0.75 to 1 ns time resolution. Reasonable efficiencies are reached for energies up to ~ 30 keV. The various nuclear resonance techniques demand various detector schemes. Future scientific challenges demand a development of 1D and 2D detectors. First attempts with a 1D detector and 0.2 ns time resolution (Deschaux-Baume *et al.*, 2006) have just been carried out allowing visualisation using magnetic small-angle scattering of the dynamics of magnetic domains. Furthermore, in order to access Mössbauer isotopes with high transition energies (> 30 keV) further developments have to be initiated.

Support facilities

The proposal would benefit from the envisaged facilities and especially from the development of fast detectors.

References

- Deschaux-Baume T. *et al.*, 2007 to be published.
- Gupta A., Gupta M., Chakravarty S., Ruffer R., Wille H.-C., and Leupold O. (2005), Fe diffusion in amorphous and nanocrystalline alloys studied using nuclear resonance reflectivity, *Phys. Rev. B*, **72**, 014207.
- Pasquini L., Barla A., Chumakov A.I., Leupold O., Ruffer R., Deriu A., and Bonetti E. (2002), Size and oxidation effects on the vibrational properties of nanocrystalline α -Fe, *Phys. Rev. B*, **66**, 073410.
- Röhlberger R., Thomas H., Schlage K., Burkel E., Leupold O., and Ruffer R. (2002), Imaging the Magnetic Spin Structure of Exchange-Coupled Thin Films, *Phys. Rev. Lett.*, **89**, 237201.
- Nagy D.L., Botyán L., Croonenborghs B., Deák L., Degroote B., Dekoster J., Lauter H.J., Lauter-Pasyuk V., Leupold O., Major M., Meersschant J., Nikonov O., Petrenko A., Ruffer R., Spiering H., and Szilágyi E. (2002), Coarsening of Antiferromagnetic Domains in Multilayers: The Key Role of Magnetocrystalline Anisotropy, *Phys. Rev. Lett.*, **88**, 157202.
- Stankov S., Röhlberger R., Slezak T., Sladeczek M., Sepiol B., Vogl G., Chumakov A., Ruffer R., Spridis N., Lazewski J., Parlinski K., and Korecki J. (2006), Phonons in iron: from the bulk to a strained epitaxial monolayer, *ESRF Highlights 2006*, 9-10.
- Sepiol B., Meyer A., Vogl G., Ruffer R., Chumakov A.I., and Baron A.Q.R. (1996), Time Domain Study of ^{57}Fe Diffusion using Nuclear Forward Scattering of Synchrotron Radiation, *Phys. Rev. Lett.*, **76**, 3220.

PHIXS: Phonon Inelastic X-ray Spectroscopy

Summary

The HRRS Group currently operates two stations (ID16-1 and ID28), dedicated to the study of phonon- and phonon-like excitations in liquid, disordered and crystalline materials by inelastic X-ray scattering (IXS). In order to keep pace with the current challenges in science, to cope with the high over subscription and to preserve the ESRF's world leading role in this field of research, these stations must be upgraded. Efforts on ID16-1 shall be focused to provide a state-of-the-art spectrometer for the study of liquid and disordered matter and to exploit the possibility of providing sub-meV energy resolution (see CDR INELX). The aim of the present project is the construction of a high-throughput inelastic X-ray scattering spectrometer, devoted to the determination of elastic, vibrational and thermodynamic properties of crystalline materials relevant for applications in fields ranging from biology to nanoscience. We envisage that a factor of ten in efficiency may be gained compared to the present instrument. Besides the instrument upgrade, the project comprises theoretical and computational developments

and shall provide the user community with:

- A highly brilliant X-ray beam with meV energy resolution and a focal spot size of $20 \times 5 \mu\text{m}^2$, coupled to a multi-analyser (30 to 50 elements) spectrometer for parallel data collection.
- An average decrease of the data collection time by a factor ten, therefore reducing typical experiment times from several days down to hours.
- Optimised alignment routines and a user friendly interface for an efficient use of the beamtime.
- A software package allowing experiment preparation, online data analysis and measurement strategy optimisation.

Our proposal contains completely new avenues in data taking strategies. Consequently, not only will the whole user community largely benefit, but it promises to pave the way for IXS towards a routine tool in material research. Besides strengthening the current research programmes new opportunities will emerge. Examples include:

- Strongly correlated electron systems such as superconductors and actinides: study of the interplay of structural, electronic and lattice degrees of freedom (D'Astuto *et al.*, 2002; Wong *et al.*, 2003);
- High pressure science (diamond anvil cell techniques and laser heating): experimental determination of sound velocities, elastic moduli and thermodynamic properties in materials relevant for Earth and Planetary Sciences (Fiquet *et al.*, 2001; Ghose *et al.*, 2006);
- Material science: Additional insight into the structure/hardness relation and determination of *intrinsic* elastic properties of textured materials (Bosak and Krisch, 2006);
- Surface science and nanotechnology: vibrational properties of quantum dots, thin organic and inorganic films, and surfaces, using grazing incidence techniques (Murphy *et al.*, 2005);
- Biological and radiation sensitive materials for which a more efficient spectrometer will minimise radiation damage (Angelini *et al.*, 2006);
- Stroboscopic phonon spectroscopy with time resolution of a few seconds for the study of phase transformations, *i.e.* the microscopic decomposition kinetics in ionic solids (Elter *et al.*, 2005).

Due to the large variety of materials studied, there is strong overlap with other scientific programmes at the ESRF and, consequently, the project will largely benefit from parallel developments, primarily in the field of material research, surface science, science at extreme conditions and its associated infrastructures.

Scientific case

Overview

Progress in materials research is intimately linked to the use and development of powerful and efficient

analytical techniques, aiming at a complete understanding of the materials' structural, electronic and vibrational properties. In view of the current trends towards complex (microstructured) materials, thin films and nanotechnologies, novel approaches to link the microscopic characterisation with the macroscopic properties are indispensable. Traditionally, three different analytical approaches can be distinguished: diffraction, microscopy (imaging) and spectroscopy. Their use and impact in materials research is closely connected to the maturity of the technique and to the timescale in which relevant results can be obtained.

Whilst inelastic X-ray scattering (IXS) from phonons has succeeded in evolving into a valuable spectroscopic tool within less than ten years, its broad application is hampered by the fact that (i) typical experimental times range from one to two weeks, (ii) various applications are still under development and (iii) experimental preparation and results are not routinely coupled to powerful computer based theoretical simulations. Nevertheless, recent experiments give a flavour of possible future breakthroughs (see above examples and references). The development of IXS as a routine tool in material science is highly desirable, since IXS allows the determination of a wealth of elastic and thermodynamic properties, therefore providing critical input for a complete material characterisation. In order to overcome the limitations of IXS outlined above, significant efforts have to be undertaken (i) to couple the experimental results with highly developed and efficient (*ab initio*) lattice dynamics calculations, (ii) to enhance the spectrometer efficiency by at least a factor of ten, and (iii) to develop and implement new data taking strategies and techniques. These are outlined below.

Techniques

Determination of phonon dispersion in single crystals

Traditionally phonon dispersion is mapped out point-by-point along the high-symmetry directions, exploiting the phonon selection rules in the dynamical structure factor by judicious choice of the sample orientation and scattering angle. This strategy becomes particularly time consuming for complex materials with many atoms per unit cell, if the complete phonon dispersion is to be determined. A multi-analyser system will circumvent this shortcoming. The simultaneous collection of IXS spectra spanning several Brillouin zones for about five sample positions only, should allow the reliable reconstruction of the full dispersion scheme.

Determination of phonon dispersion in polycrystalline materials

IXS studies on polycrystalline materials have so far only provided orientation-averaged properties such as the average longitudinal sound velocity, the aggregate compressional modulus (from low momentum-transfer

(Q) spectra), or the vibrational density-of-states (from high-Q spectra, see below). On the other hand, IXS spectra, collected over the whole accessible Q-range from typically 2 to 70 nm⁻¹ still display a marked Q-dependence due to - though relaxed - selection rules and therefore contain information on the single crystal lattice dynamics. A least squares refinement of model calculations versus the experimental IXS spectra then allows access to the single crystal properties. This strategy is currently intensively pursued within the frame of a thesis, and has already given very promising results for a test case study on beryllium.

Determination of the phonon density-of-states

The experimental determination of the energy distribution function $g(E)$, or vibrational density-of-states (VDOS), gives important insight into the physical properties of materials, since it allows the derivation of many thermodynamic and elastic properties. This is commonly done by inelastic neutron scattering (INS) or nuclear inelastic scattering (NIS), and has been recently developed for IXS as well (Bossak and Krisch, 2005). With respect to INS the probed sample volumes (down to 10⁻⁵ mm³) are several orders of magnitude smaller than for INS, and with respect to NIS the technique is not limited to Mössbauer isotopes. Several macroscopic parameters such as, for example, the specific heat at constant volume, the low and high temperature limit of the Debye temperature θ_D , and the average sound velocity v_D can be directly derived from the VDOS.

Phonons in surface sensitive geometry

Inelastic X-ray scattering offers the unique possibility of studying surface and bulk dynamics in a single experiment. This can be achieved by setting the sample in the condition of grazing incidence thus holding the incoming X-rays below the critical angle of total external reflection. In this case, the incident electromagnetic field displays an exponential decay in the sample bulk with a typical probing depth of only a few nanometres. By increasing the incidence angle beyond the critical angle one can penetrate deep into the sample bulk. Such a surface sensitive setup was developed on ID28, and the first successful experiments were conducted on NbSe₂ and liquid indium (Murphy *et al.*, 2005; Reichert *et al.*, 2007).

Context with new sources and user community

The proposed project is indispensable to ensure the ESRF's world leadership in the field of X-ray phonon spectroscopy. At present there are two other operating instruments (one at APS and one at SPRING-8) with comparable performances. The APS, SPRING-8, but also PETRA-III, NSLS-II and DIAMOND have similar projects in the design phase with superior target

characteristics compared to the present capabilities of ID16 and ID28. The enhanced capabilities of the instrument will reduce the notorious heavy over subscription and naturally enlarge the user community.

Technical considerations

General beamline layout considerations and characteristics

General remarks: Most of the considerations are identical to those concerning the proposed upgrade of ID16-1 (see CDR INELX). IXS can not profit from the general trend towards very long beamlines to obtain sub-micron focal spot sizes, since the resulting large divergence of the X-ray beam is not compatible with the required momentum transfer resolution. As a consequence the general beamline layout is similar to the existing one. Special requirements are:

- Vibrational stability: $\leq 1 \mu\text{m}$ RMS at the sample position.
- Thermal stability: $\leq 0.1 \text{ K}$ over 24 hours in the crystal analyser hutch. This implies that (i) the analysers will be housed in a room, separated from the rest of the experimental hutch, and (ii) the spectrometer will be quasi-static.

Undulators: They should provide the highest flux at 17794 eV and 21747 eV. With the present configuration (10 mm vacuum chamber) this can be accomplished by two short-period 'mono'-harmonic undulators.

Premonochromatisation: This is accomplished by a cryogenically cooled silicon [111] channel cut monochromator and a silicon [331] post-monochromator. This combination provides an energy bandwidth of $\Delta E/E = 1.44 \times 10^{-5}$ and a sufficiently low heat load that the intrinsic energy resolution of the back scattering monochromator is not deteriorated.

Main monochromator: It can be kept in the present configuration (vertical scattering with horizontal asymmetry angle of $\alpha = 75^\circ$). Due to the use of collimating refractive lenses (installed in OH1) the constraint of operating at a Bragg angle of 89.98° can be relaxed, and the monochromator will operate at 89.8°.

Focusing scheme: It will consist of a single platinum coated ellipsoidal mirror working at a glancing angle of 2.7 mrad, and installed at 2.5 m from the sample position (102 m away from the source). The expected focal spot size is 20 x 5 μm^2 (horizontal x vertical) with a divergence of 1.6 x 0.8 mrad². Alternative solutions consist of an elliptical mirror coupled to in-line optics or a graded multilayer. Insertion of a flat, horizontally deflecting optics is considered to increase the available space around the sample position.

Sample goniometer: An upgrade to a kappa diffractometer is planned for 2007.

Spectrometer: It will be equipped with 30 to 50 analysers and operate in the horizontal plane.

The key development concerns the detector. At present we employ a prototype monolithic five element detector with individual $3 \times 8 \times 1.5 \text{ mm}^3$ thick silicon diodes. The production and reproducibility of the silicon chips has encountered problems in the recent past, and although these detectors have an excellent performance in terms of efficiency and dark count rate, alternative solutions have to be investigated, *e.g.* Cd(Zn)Te point detectors (as used by the IXS beamlines at APS and SPRING-8), or 2D detectors such as the Medipix or Pilatus systems, based on silicon technology. There are also efforts to develop Cd(Zn)Te pixel detectors for space research applications. This type of detector represents an attractive alternative, due to the much higher photoelectric absorption. Finally, commercially available solutions exist for segmented Si(Li) detectors which are cooled by a novel maintenance-free pulsed tube design (Canberra-Eurisys). The various solutions are currently being studied.

Support facilities

Sample environment: The project will largely benefit from the various developments foreseen in the Upgrade Programme, most notably for science at extreme conditions.

Computing: Fast computers are primarily needed for the data analysis from polycrystalline samples. The least squares refinement of the dynamical matrix can be parallelised on typically up to 30 computers. This should result in an average analysis time of about 30 minutes with state-of-the-art processors.

References

- Angelini T.E., Golestanian R., Coridan R.C., Butler J.C., Beraud A., Krisch M., Sinn H., Schweizer K.S., and Wong G.C.L. (2006), Counterions between charged polymers exhibit liquid-like organization and dynamics. *Proc. Nat. Acad. Sci. USA*, **103**, 7962.
- Bosak A. and Krisch M. (2006), Lattice dynamics of tetrahedrally bonded boron nitride, *Rad. Phys. and Chem.*, **75**, 1661.
- Bossak A. and Krisch M. (2005), Phonon density of states probed by inelastic X-ray scattering, *Phys. Rev. B*, **72**, 224305.
- D'Astuto M.P., Mang K., Giura P., Shukla A., Ghigna P., Mirone A., Braden M., Greven M., Krisch M., and Sette F. (2002), Anomalous dispersion of longitudinal optical phonons in $\text{Nd}_{1.86}\text{Ce}_{0.14}\text{CuO}_{4+\delta}$ determined by inelastic X-ray scattering, *Phys. Rev. Lett.* **88**, 167002.
- Elter P., Eckold G., Gibhardt H., Schmidt W., and Hoser A. (2005), Kinetics of decomposition in ionic solids: IV: Transition between nucleation and spinodal decomposition observed by time-resolved phonon spectroscopy, *J. Phys.: Condens. Matter*, **17**, 6559.
- Fiquet G., Badro J., Guyot F., Requardt H., and Krisch M. (2001), Sound velocities in iron to 110 Gigapascals, *Science*, **291**, 468.
- Ghose S. Krisch M., Oganov A.R., Beraud A., Bosak A., Gulve R., Seelaboyina R., Yang H., and Saxena S.K. (2006).

Lattice dynamics of MgO at high pressure: Theory and experiment. *Phys. Rev. Lett.*, **96**, 035507.

- Murphy B.M., Requardt H., Stettner J., Serrano J., Krisch M., Müller M., and Press W. (2005), Phonon modes at the 2H-NbSe₂ surface observed by grazing incidence inelastic X-ray scattering, *Phys. Rev. Lett.*, **95**, 256104.
- Reichert H., Bencivenga F., Wehinger B., Krisch M., Sette F., and Dosch H. (2007), High-frequency subsurface and bulk dynamics of liquid indium, *Phys. Rev. Lett.* **98**, 096104.
- Wong J., Krisch M., Farber D.L., Occelli F., Schwartz A. J., Chiang T.-C., Wall M., Boro C., and Xu R. (2003), Phonon Dispersions of fcc δ -Plutonium-Gallium by Inelastic X-ray Scattering, *Science*, **301**, 1078.

XAS-XES: Steady-State and Time-Resolved X-ray Absorption and Emission Spectroscopy

Summary

The beamline is dedicated to the study of the electronic structure and coordination of atoms in matter using high energy resolution¹ emission detection in connection with hard X-ray absorption spectroscopy (XAS). X-ray emission spectroscopy (XES) represents a development beyond standard XAS that provides information on orbital splittings, hybridisation and populations as well as the valence band spin-state that cannot be accessed using any other technique. Since it also enables studies of the density of occupied electronic states and low energy excitations of a few electron volts, it is complementary to valence band photoemission and optical spectroscopy with the advantage of being truly bulk sensitive, element specific and compatible with various sample conditions.

A wavelength dispersive setup in Bragg geometry allows an instrumental energy bandwidth below the core hole lifetime broadening. A large solid angle spectrometer that employs five analyser crystals is currently being developed with the possibility for an upgrade to 10 or 18 analysers. The instrument is designed to serve a large user community and can be adjusted to either optimise the captured solid angle or the energy resolution. Possible applications range from the study of metals in coordination chemistry and life science via earth science to materials science.

X-ray absorption and emission spectroscopy will be applied in steady state and time-resolved mode with the time resolution limited by the incident X-ray pulse length (currently ~100 ps). The beamline will feature a femtosecond laser with a 3 kHz repetition rate for optical pumping. The combination of high energy

resolution emission detection with picosecond time resolution will be a new type of experiment that is not yet realised and that will make it possible to follow the time evolution of a system after external excitation element selectively with respect to electronic structure and local coordination.

The user community for time-resolved XAS-XES will mainly emerge from research groups that already use time-resolved techniques and have so far not considered the potential of inner-shell spectroscopies. This concerns the large field of photochemistry (photo-voltaic, photo(bio)catalysis, photofragmentation, ...) but also topics in materials science to advance, for example, the development of optical devices or to study the magnetic response to an applied field.

The main aspects of the proposed beamline are:

- Promote XES for a large user community as a tool to study local coordination and electronic structure.
- Realise XAS and XES with time resolution below the nanosecond range.

Scientific case

Overview

Knowledge of the electronic structure and coordination of atoms in matter holds the key to the understanding of material properties as well as chemical behaviour and reaction kinetics. Inner-shell spectroscopies provide an element specific probe and thus yield information that is complementary to 'table-top', *i.e.* more readily available, techniques such as IR, EPR, UV-Vis or optical Raman spectroscopy.

X-ray absorption spectroscopy (XAS) is most sensitive to the local coordination while non-resonant and resonant X-ray emission spectroscopy (XES) reflects the spin-state and electron orbital configuration. (Glatzel and Bergmann, 2005) The possible applications cover many scientific fields represented at the ESRF (chemistry, biology, materials science, geology/mineralogy, environmental sciences) and the beamline thus reaches out to a large and broad user community.

The combination of spectroscopy with time-resolution offers a powerful tool to study excited states, reaction kinetics and dynamics as well as the response to an external magnetic or electric field. Whilst this has been realised in many laboratories using table-top techniques, time-resolved inner-shell spectroscopy at synchrotron radiation sources is a new and emerging field (Bressler and Chergui, 2004; Chen, 2004). An element specific probe combined with time resolution gives valuable information concerning local electronic and structural changes that will help to understand processes that are triggered by an external excitation on an atomic level.

X-ray photon-in-photon-out spectroscopies are furthermore bulk sensitive and have the advantage of being compatible with various sample environment (*in situ* chemistry, extreme conditions).

Important applications are in the fields of chemistry, life sciences and materials science. Pump-and-probe schemes with time resolutions in the micro- to picosecond range can reveal structural changes in coordination chemistry, proton coupled electron transfer and electron migration in biology, the decay kinetics of excitons in semiconductors as well as melting and spin-orbital dynamics in materials science.

Examples

The migration and decay of charge carriers in photoexcited semiconductors need to be understood in order to design optimised photo-catalysts or optical devices. Photoexcited electrons and holes in a semiconductor can trigger chemical reactions of surface adsorbates (Thompson and Yates, 2006). The photoreduced ions in the semiconductor are detectable in the X-ray absorption near edge as well as in the X-ray emission spectra (K β spectroscopy). A large number of semiconductors (TiO₂, ZnO, CeO₂, ...) with different dopings is being investigated, all showing high activity for different applications.

An interesting aspect of the combination of XAS with XES is given by the fact that the K β emission line is strongly sensitive to the 3d transition metal spin state while it is largely independent of structural changes that leave the local spin moment unchanged. This opens up the possibility of separating electronic from structural changes. An important case is the spin cross-over of Fe³⁺ in heam-proteins (Franzen, 2002). High-spin Fe³⁺ species are biologically labile because of their oxidising capability. By changing the spin state from high spin to low spin, the Fe³⁺ maintains its oxidation state but becomes biologically inactive. The change in spin state is induced by conformational changes of the ligand environment, which constitute or assist the function of the metal site through the electronic structure.

Electron transfer reactions in proteins occur on timescales ranging from sub-picoseconds to milliseconds (Tezcan *et al.*, 2001). Understanding their biochemical functions requires knowledge of the pathway and dynamics of electron transfer. For naturally photoactive proteins (*e.g.* photosynthetic reaction centres), the excited-state can be populated using ultrashort optical pulses to synchronise the time course of a biological reactions. For naturally non-photoactive proteins, a photosensitiser is required and acts as a trigger to initiate the electron transfer processes. The electron transfer to and from metal centres are detectable in the absorption and emission spectra.

Techniques

The techniques based on high energy resolution emission detection are:

- Non-resonant X-ray emission spectroscopy;
- Resonant X-ray emission or resonant inelastic X-ray scattering spectroscopy;
- High-energy resolution fluorescence detected absorption spectroscopy.

XAS and XES are complementary techniques. While XAS is established with a constantly improving theoretical understanding, only few studies using non-resonant XES have been performed even though the potential has been recognised (Glatzel and Bergmann, 2005). XAS can be combined with XES to give high-energy-resolution fluorescence detected (HERFD) XAS and resonant inelastic X-ray scattering (RIXS) spectroscopy. HERFD-XAS yields absorption-like spectra with considerably improved spectral resolution (van Bokhoven *et al.*, 2006). RIXS spectroscopy is widely used in condensed matter and materials science to study electronic configurations and ligand field effects. It is now being discovered also by the applied fields outside the physics community (Pirngruber *et al.*, 2006; Glatzel *et al.*, 2004).

The beamline will combine its expertise in wavelength dispersive X-ray emission detection with time resolution and will therefore focus on time-resolved fluorescence detected absorption and emission spectroscopy. This will distinguish the beamline from projects on other storage rings. Even though it is desirable to push the time resolution below the current limit of 100 ps, already a large number of relevant questions concern the micro- and nanosecond time regime. The paramount goal is to optimise the signal-to-background ratio and the detection sensitivity to obtain high quality data even for dilute systems with low conversion rates. This is realised in X-ray emission detection with lifetime resolution whilst maximising the captured solid angle.

The wavelength dispersive setup allows X-ray pulse separation to be achieved by means of a fast detector (Avalanche Photo Diode). The advantage of fluorescence detection over transmission absorption spectroscopy in laser pumped schemes is the favourable match in attenuation length between the pump and probe pulses (Chen, 2004). The beamline will thus specialise in the non-standard techniques XES, HERFD-XAS and RIXS spectroscopy in combination with time resolution.

For fastest time resolution, the delay between a femtosecond laser and the X-ray pulse is varied, *i.e.* the experiment is performed in stroboscopic mode. Here the limit is given by the pulse length from an electron bunch which currently is around 100 ps. For decay constants of several hundreds of nanoseconds,

additionally to the delay variation, several subsequent bunches can be used to study the decay kinetics resulting in increased efficiency.

Context with new sources and user community

The techniques XES, RIXS and HERFD-XAS have been recognised by a growing number of scientists in the XAS user community as a viable and powerful development beyond standard absorption spectroscopy. By pushing the detection limit for emission spectroscopy with a large solid angle spectrometer, the technique becomes attractive for very dilute and radiation sensitive samples but also for time-resolved studies where only a fraction of the incident X-rays can be used and possibly low conversion rates in pump-and-probe schemes ask for the best possible signal-to-background ratio.

Time-resolved X-ray absorption spectroscopy is currently being pursued at several synchrotron radiation sources. Many studies are performed in transmission mode but developments have been made to also perform fluorescence detected absorption spectroscopy using an APD or a germanium detector (Chen *et al.*, 2001). Some efforts are under way, *e.g.* at the APS, to use Laue analysers and multilayers in connection with faster detectors. To our knowledge, none of the third-generation synchrotron radiation facilities plans to realise time-resolved spectroscopy using Bragg optics for X-ray emission detection.

The scientific case for time-resolved spectroscopy presented here is distinct from the femtosecond realm that will be realised at the XFEL. Whilst in the latter, for example, non-linear processes or coherent atomic displacements in vibrational relaxations will be studied, this design report addresses the large field of photo(bio)chemistry with non-coherent atomic motions and electron transfer but also topics in material science with time evolutions in the picosecond range and slower. Nonetheless, the successful operation of the proposed beamline will give valuable input for time-resolved spectroscopy on the fourth generation sources.

Technical considerations

A Bragg spectrometer will be designed to serve a large user community. In a first stage the spectrometer will consist of an array of five analyser crystals with a diameter of 100 mm. The spectrometer will accommodate crystal bending radii between 0.5 and 2 metres to either maximise the captured solid angle or minimise the energy bandwidth. It will operate with the Rowland circles oriented vertically in order to optimise the energy resolution and the reproducibility of the energy calibration.

Either silicon or germanium crystal wafers glued or bonded on a spherical substrate will be used as analyser crystals. Silicon analysers can be produced at the ESRF. A research and development programme is currently under way to improve the quality of the silicon analysers and to master the fabrication of germanium analysers. At the moment, only one company worldwide (Crysmatec/Saint-Gobin) is able to produce spherically bent germanium crystals. Once a fabrication process has been established, the manufacturing of a considerable number of analyser crystals has to be realised. To cover the fluorescence energies of all 3d transition metals a total of twelve different reflections are necessary (six germanium, six silicon) giving a total of 60 analyser crystals. Additional reflections will become necessary for the emission lines of the 5d metals at higher energies. We also point to the needs of other ESRF beamlines (e.g. ID16) and possibly other storage rings.

All wavelength dispersive detection schemes require a beam spot of less than 100 μm^2 for optimised energy resolution and efficiency. However, radiation damage due to the intense X-ray beam can be limited by reducing the photon density in a larger spot with homogeneous intensity distribution. Thus, the beam size should be as small as necessary and as large as possible. Two Kirkpatrick-Baez mirror systems, one in the optics hutch and one in the second experimental hutch, will provide the required flexibility.

The instrumentation for time-resolved experiments with optical pumping will be developed in close collaboration with the group of Michael Wulff (CDR: TRD) that has extensive experience in time-resolved diffraction experiments. A tuneable femtosecond laser with 3 kHz repetition rate will be installed and interfaced with the emission spectrometer. A fast chopper is necessary to protect radiation sensitive samples by blocking unused X-ray pulses. X-ray and laser pulses can be synchronised using a GaAs detector. X-ray detection will be realised using a fast detector that will be interfaced and synchronised with the laser pump and X-ray probe pulse.

The beamline will not be dedicated to time-resolved studies but will continue also the user programme for steady-state spectroscopy for several reasons. Firstly, this will assure efficient use of the available beam time. Secondly, no comparable end-station for X-ray emission detection is currently planned at any European synchrotron radiation source. Thirdly, the theoretical interpretation and its validation require comprehensive experimental studies in steady-state experiments. Finally, time-resolved experiments on dilute samples with low conversion rates require the best possible performance of all experimental components. The experience from the steady-state time will help to reach the optimal beamline performance.

Many user groups would appreciate a combination of the X-ray experiment with a table top probe in order to verify sample integrity and to facilitate comparison with results obtained at their home laboratories. Implementation of an IR and/or optical Raman probe for simultaneous data recording will be realised in collaboration with other beamlines (e.g. current ID24/BM29).

References

- Bressler C. and Chergui M. (2004), Ultrafast X-ray absorption spectroscopy, *Chemical Reviews*, **104**, 1781-1812.
- Chen L.X., Jager W.J.H., Jennings G., Gosztola D.J., Munkholm A., and Hessler J.P. (2001), Capturing a photoexcited molecular structure through time-domain X-ray absorption fine structure, *Science*, **292**, 262-264.
- Chen L.X. (2004), Taking Snapshots of Photoexcited Molecules in Disordered Media by Using Pulsed Synchrotron X-rays, *Angewandte Chemie - Int. Ed. in English*, **43**, 2886-2905.
- Glatzel P. and Bergmann U. (2005), High resolution 1s core hole x-ray spectroscopy in 3d transition metal complexes - Electronic and structural information, *Coordination Chemistry Reviews*, **249**, 65-95.
- Glatzel P., Bergmann U., Yano J., Visser H., Robblee J.H., Gu W.W., de Groot F.M.F., Christou G., Pecoraro V.L., Cramer S.P., and Yachandra V.K. (2004), The electronic structure of Mn in oxides, coordination complexes, and the oxygen-evolving complex of photosystem II studied by resonant inelastic X-ray scattering, *J. Am. Chem. Soc.*, **126**, 9946-9959.
- Franzen S. (2002), Spin-dependent mechanism for diatomic ligand binding to heme, *Proc. Natl. Acad. Sci. USA*, **99**, 16754-16759.
- Pirngruber G.D., Grunwaldt J.D., van Bokhoven J.A., Kalytta A., Reller A., Safonova O.V., and Glatzel P. (2006), On the presence of Fe(IV) in Fe-ZSM-5 and FeSrO_{3-x} – Unequivocal detection of the 3d(4) spin system by resonant inelastic X-ray scattering, *J. Phys. Chem. B*, **110**, 18104-18107.
- Thompson T.L. and Yates J.T. (2006), Surface science studies of the photoactivation of TiO₂-new photochemical processes, *Chemical Reviews*, **106**, 4428-4453.
- Tezcan F.A., Crane B.R., Winkler J.R., and Gray H.B. (2001), Electron tunneling in protein crystals. *Proc. Natl. Acad. Sci. USA*, **98**, 5002-5006.
- van Bokhoven J.A., Louis C.T., Miller J., Tromp M., Safonova O.V., and Glatzel P. (2006), Activation of oxygen on gold/alumina catalysts: *In situ* high-energy-resolution fluorescence and time-resolved X-ray spectroscopy, *Angewandte Chemie-International Edition*, **45**, 4651-4654.

¹ We define "high energy resolution" as detecting the emitted X-rays with an instrumental energy bandwidth on the order of the core hole lifetime broadening (~1 eV).

Introduction to the Conceptual Design Reports of the Macromolecular Crystallography Group

The Upgrade Programme of the suite of ESRF macromolecular crystallography (MX) beamlines aims to provide a uniform, accessible platform for carrying out MX experiments at the highest level possible. To achieve this goal, a suite of beamlines designed for rapid sample screening would be amongst those provided. Subsequent distribution of samples to beamlines optimised for microfocus applications (MX-MAD1/MX-MICROFOCUS), anomalous dispersion (AD) experiments with mini-focus (MX-MAD1/MX-MICROFOCUS) and optional microfocus capabilities (MX-MAD2) and AD facilities capable of dealing with very large unit cells ($>1000 \text{ \AA}$, MASSIF) would then take place. The creation of this facility would be unique and would ultimately offer significant new opportunities for the investigation of the most challenging structural biology research areas.

The maximum benefit from these proposals would be gained by relocating the MX beamlines so that they are close together on the experimental floor. If this was the case, the use of the most appropriate end-stations for experiments that follow initial screening becomes easier as the logistics issues associated with the movement of cryo-cooled samples between beamlines are minimised. However, a substantial storage area for cryo-dewars and cryogenically frozen samples is still required and a radically different mode of access and operation of the MX suite including remote control would also need to be envisaged.

Increasingly, structural biology is turning from the structural investigation of single proteins to the more biologically relevant study of macromolecular complexes. This trend has accelerated the need for screening facilities to test crystal diffraction and has implied an increased use of complementary biophysical techniques *i.e.* SAXS, X-ray imaging, electron microscopy (see the CDRs in the Soft Condensed Matter and Imaging Groups), in order to improve the understanding of the system under study. Recognising these developments, the proposals from the MX Group contain facilities which would traditionally form part of a different research infrastructure. Their inclusion here, though, is valid because the most significant challenge for the study of biological systems is usually the production and subsequent maintenance of the sample. To this end, the study of biological systems will be greatly aided by the support afforded through the close proximity of, and collaboration with, the partner institutes comprising the Partnership for Structural Biology.

Taken in their entirety, the cases presented provide a structure for the continued pursuit of scientific excellence in the field of Structural and Functional Biology, building upon the vast experience of the ESRF in this area. The proposals could result in a co-located suite of beamlines with an enhanced interaction with biologically relevant developments contained within the ESRF Upgrade Programme.

Summary of individual CDRs

| | | |
|----------------------------------|--|---------|
| MASSIF | Massively Automated Sample Screening Integrated Facility: suggested location on ID02): A canted beamline with end-stations dedicated to sample screening, plus a fully tuneable end-station with low divergence X-ray beam for large unit cells. | page 20 |
| MX-BIB | Biological Imaging Beamline: suggested location on a canted ID01: A beamline dedicated to the imaging of biological samples using coherent diffraction imaging. | page 22 |
| MX-MAD1 and MX-MICROFOCUS | Macromolecular Crystallography using Multi-Wavelength Anomalous Dispersion and Microfocus: suggested location on a canted ID03: A canted beamline for with a wide energy range, tuneable end-station and a 1 to 10 micron microfocus end-station. | page 24 |
| MX-MAD2 | Macromolecular Crystallography using Multi-Wavelength Anomalous Dispersion with Microfocus: suggested location on a canted ID01: a variable focus (<10 to 100 microns), tuneable energy beamline. | page 26 |

MASSIF: Massively Automated Sample Screening Integrated Facility

Summary

This CDR proposes the development of a highly automated screening facility for assessing the diffraction properties of macromolecular crystals. The concept is unique and tackles a fundamental problem associated with MX – the variability of sample quality. We aim to use the screening facility as the initial testing point for cryo-cooled samples. Following initial testing these will be transferred to the most appropriate beamline within the ESRF MX suite. In order to enable the logistics of this mode of operation, it is desirable that the MX beamlines are closely spaced on the ESRF experimental hall floor.

The second beamline covered in this report is a multi-wavelength anomalous dispersion beamline which will be optimised to deal with weakly diffracting crystals with large unit cells.

Scientific case

Overview

MX is *the* key tool for the understanding of the function of biological systems. Rapid growth of the field has been observed worldwide with the European Community funding a number of Integrated Projects that focus on the most challenging areas of structural biology: VIZIER (identification of potential new drug targets against RNA viruses), 3D Repertoire (resolution of structures for all amenable protein complexes from budding yeast), SPINE2 (structures of complexes from signalling pathways linking immunology, neurobiology and cancer). All of these projects attempt to investigate complex areas of biology using the techniques of structural biology and, in particular, MX.

In practice, the use of MX means that one is required to investigate crystals with unit cell dimensions in the range of 10 Å to 1000 Å, leading to a potential dynamic range in diffracted intensities of over six orders of magnitude. A further complication arising from addressing more complex systems is that the variation of crystalline samples from *within the same production batch* can vary dramatically. It is routine to screen tens to hundreds of samples for their diffraction properties before full data collection on different beamlines (or even synchrotron facilities) (Selmer *et al.*, 2006; Dong, 2006) takes place.

Because the diffraction experiment results only in structure factor amplitudes and all phase information is lost, special techniques are required for the experimental solution of the phase problem. Currently the most powerful techniques for this are based on anomalous dispersion (AD) (Hendrickson, 1991; Dauter *et al.*, 2002). These rely on the accurate measurement of the small changes in intensities resulting from data collection at (sometimes several) photon energies close to an absorption edge. Typically the AD signal is of order of 2 to 3% of the structure factor amplitude. Unfortunately, synchrotron radiation damages the sample, leading to changes in the structure factors that are greater than the signal being searched for (Ravelli and McSweeney, 2000). Thus, the successful elucidation of macromolecular structures places a very heavy premium on the identification and optimal use of the most appropriate sample for the experiment to be performed.

The aim of this proposal, Massively Automated Sample Screening Integrated Facility (MASSIF), is to enable screening of MX samples on several (for example two) dedicated end-stations. Real time ranking of results will be used to identify the “best” samples and to inform experimenters on the choice of beamline most appropriate to obtain the best quality data and thus ensure success of the experiment. With the availability of such a facility it will become routine to screen many samples before a data collection is initiated and this will, in turn, lead to changes in the allocation and exploitation of beam time. MASSIF could occupy one branch of a canted beamline.

On the second canted branch of the facility we would construct a MAD capable beamline. This station, exploiting the low horizontal divergence of a high β straight section, would be adapted to the needs of very large unit cells, equipped with instrumentation appropriate for the resolution of many (> 1000) diffraction orders and allow collection of diffraction data to very low resolution (< 200 Å) for overlap with cryo-electron microscopy data.

In addition to the proposed screening facility, the MASSIF branch of the canted line would be suitable for the creation and installation of an end-station dedicated to the investigation of macromolecular structure in solution using SAXS/WAXS techniques. We envisage that such a facility would benefit from the expertise in sample handling and preparation that would come from its inclusion within the Partnership for Structural Biology and would benefit from close collaboration with similar activities at both the Institut Laue Langevin and the ESRF. The proposed facility could also be used to further develop the technique of synchrotron radiation foot printing (Goldsmith *et al.*, 2001) as a means of probing interactions in complexes of macromolecules.

Taken together, this proposal would form a unique experimental facility which, combined with a co-localisation of the MX beamlines, would ensure that the ESRF continues to lead the world in elucidating the structures of the most difficult and challenging structural biological projects.

Techniques

Branch A: (Multi-wavelength) anomalous dispersion
Branch B: Fixed energy single crystal diffraction screening with complementary biophysical techniques and analysis.

Context with new sources and user community

The facility would be unique.

The availability of an increased number of MX beamlines within Europe will allow better "load balancing" for an expanding user community. This new sharing of demand offers the ESRF an opportunity to focus on scientific excellence based upon the experience gained in pioneering the use of third-generation sources for MX. By an appropriate strategic positioning combined with the necessary infrastructure developments, the ESRF will remain at the forefront of structural biology research. The European MX user community now expects a common interface to all synchrotron facilities and the ESRF, with its incomparable experience in MX automation, should take a leading role in this. The fact that the ESRF MX Group is involved, and takes a leading role, in a number of European projects or collaborations involving other EU synchrotrons, the user community and national institutes/universities (*i.e.* SPINE, BioXhit, the Centre for Integrated Structural Biology (CISB) and the DNA collaboration) will help to ensure that this is the case.

As mentioned above, a sample screening facility associated with ultra-modern MX beamlines would imply drastically new access modes for the user community in order for it to take full advantage of the possibilities offered. These new modes of access will include mail-in crystallography and remote control. It will therefore be important to ensure a staff contingent appropriate to running an automated system: technicians/engineers for operations, MX trained scientists for the strategic overview.

In summary, the proposed suite of MX beamlines would provide a package of sample preparation and screening facilities and data collection stations complete with experienced staff that has no equal in Europe.

Technical considerations

Line B would consist of up to four end-stations multiplexed (using semi-transparent diamond monochromators as beam splitters). All end-stations would be able to operate simultaneously.

The focusing elements for line B stations would be composed of compound refractive lenses (CRL) and/or Kirkpatrick-Baez (KB) systems. A small CRL system in the front end would allow focusing for standard MX data collection. Additional focusing, for example, to provide microfocus X-rays, could be made with a KB system closer to the sample position and would be specific to each end-station. Installing many beamlines would mean a gradual reduction in intensity (a reduction in beam intensity of 4.3%/100 μm of diamond at 12.7 keV or around 6.5% per diamond monochromator using 100 μm thick diamonds with an asymmetric Laue cut as currently used on ID14). Applications, such as sample screening, SAXS on protein solutions or even a MX instrumentation test bed (to provide a dedicated facility for the testing of new instrumentation and software developments) would not require a particularly intense X-ray beam. This proposal thus provides an efficient way to enable many complementary techniques to be brought together on one undulator source.

In order to realise the full potential of a redeveloped ID14 beamline suite, one should take advantage of the developments in detector technology expected over the next few years: specifically a highly sensitive detector for the SAXS/WAXS station and a large area detector for the MAD beamline. This is especially relevant in the light of the PILATUS detector developments. Such a large area, highly sensitive detector with large dynamic range would improve and speed up MX measurements.

Support facilities

- Sample preparation and handling will require developments introduced during the development of the Partnership for Structural Biology.
- The effective use of sample screening implies the rapid redistribution of cryo-cooled samples from line B, to the most appropriate MX facility.
- Sample screening also implies the capacity to safely store, "warehouse", hundreds of cryo-shipping dewars.

References

- Dauter Z., Dauter M., and Dodson E. J. (2002), Jolly SAD, *Acta Cryst.*, **D58**, 494-506.
- Dong C., Beis K., Nesper J., Brunkan-Lamontagne A.L., Clarke B.R., Whitfield C., and Naismith J.H. (2006), Wza the translocon for E. coli capsular polysaccharides defines a

- new class of membrane protein, *Nature*, **444**, 226-229.
- Goldsmith S.C., Guan J.Q., Almo S., and Chance M. (2001), Synchrotron protein footprinting: a technique to investigate protein-protein interactions, *J. Biomol. Struct. Dyn.*, **19**, 405-418.
 - Hendrickson W.A. (1991), Determination of macromolecular structures from anomalous diffraction of synchrotron radiation, *Science*, **254**, 51-58.
 - Ravelli, R.B.G. and McSweeney, S.M. (2000), The fingerprint that X-rays can leave on structures, *Structure*, **8**, 315-328.
 - Selmer M., Dunham C.M., Murphy F.V., Weixlbaumer A., Petry S., Kelley A.C., Weir J.R., and Ramakrishnan V. (2006), Structure of the 70S ribosome complexed with mRNA and tRNA, *Science*, **313**, 1935-1942.

MX-BIB: Biological Imaging Beamline

Summary

This proposal describes a new beamline devoted to the imaging of large scale biological assemblies ranging from cells, through organelles to macromolecular assemblies. The scientific focus of the beamline complements similar activities within the ESRF (see CDRs: **CDI** and **XPCS-CXS**) and existing efforts in the MX Group. A road map for developing the technique for biological systems will be elaborated in collaboration with the appropriate ESRF groups and will use the experience of the electron microscopy groups at the *Institut de Virologie Moléculaire et Structurale* and the *Institut de Biologie Structurale* (the latter of which is a member of the Partnership for Structural Biology), which are located nearby. The second branch of a canted beamline (with CDR **MX-MAD2** on the other canted section), this station is intended to:

- Provide a facility for the routine exploitation of coherent diffraction imaging (CDI) of biological molecules and assemblies;
- Provide a tool complementary to electron microscopy imaging of cells and sub-cellular compartments;
- Position the ESRF advantageously with respect to national facilities.

Scientific case

Overview

In biology seeing is, to a large part, believing. How we see and what we see is governed by the techniques available. For the production of images of biological molecules, X-ray diffraction from single crystals

remains the most accurate and rapid technique available for acquiring knowledge of structure and thereby biological function. For imaging larger scale biological entities electron microscopy has, for a long time, been the premier technique capable of providing structural information. Recently advances in fluorescent light microscopy (Betzig *et al.*, 2006) and electron tomography (Grünewald *et al.*, 2003); (Nicastro *et al.*, 2005) have increased the resolution to which cellular or large scale objects may be imaged. However, at present, no technique can provide three dimensional imaging at nanometre resolution of the interior of non-crystalline particles in the micron size range. Coherent diffraction imaging (CDI) has the potential to fill this gap and demonstration experiments indicate that three dimensional reconstructions of cells are possible (Miao *et al.*, 2003).

In the life sciences, such techniques are needed to provide information on the internal structures of assemblies of macromolecules, protein complexes and virus particles at a resolution sufficient to recognise individual proteins and determine their relationships to each other. To deal with this problem, increasing attention is being paid to combining electron microscopy/tomography images with protein structures (CCP4 Study Weekend, 2007). All the techniques discussed above have drawbacks; imaging techniques suffer in particular with problems associated with sample thickness, chiefly being governed by the penetration depth of the photon examining the specimen. In addition, due to the weak interactions of X-rays with the sample, high doses of irradiation are required during the acquisition of images- leading to the problem of radiation damage.

The problem of radiation damage is the key issue to resolve if the use of CDI is to progress beyond demonstration experiments (Miao *et al.*, 2003; Robinson and Miao, 2004). For this reason, most successful uses of the technique have been found within materials sciences, where the use of CDI is finding increasing success. Experience with dealing with radiation damage in macromolecular crystals suggests that the use of cryo-cooling can be beneficial, if it can be utilised without introducing unwanted artefacts. Therefore a road map should be established based on experience within the MX Group for the cryo-protection of crystalline samples and from the experience in the ID10 team on the use of CDI. Additional support will be provided by employing the techniques for sample visualisation and alignment developed in order to handle small crystals. The freezing of cells will present particular problems, but will be studied in collaboration with local electron microscopy groups.

Context with new sources and user community

There is a growing user community for CDI, with progress being made in the application of the technique for materials, and some success being reported with biological test samples. The proposed CDI facility fulfils the following conditions with respect to the ESRF Upgrade Programme:

- It contributes to three scientific highlight areas associated with the Upgrade Programme: Structural and Functional Biology and Soft Matter, X-ray Imaging and Nanoscience and Nanotechnology
- A long beamline is necessary since high spatial coherence is required in both the horizontal and vertical directions. The length of the beamline would allow its positioning close to the Carl-Ivar Brändén Building (housing both the Partnership for Structural Biology and the *Institut de Virologie Moléculaire et Structurale*). This will facilitate interaction with the electron microscopy groups and enable efficient sample preparation and handling techniques to be developed.
- The beamline would provide complementarity with other techniques that are, or will be, available either at other ESRF beamlines or local institutes. These include X-ray/light fluorescence microscopy or mapping, full field microscopy, X-ray tomography, X-ray holography and cryo-electron tomography.
- CDI for biology is being developed at other synchrotrons: ALS (new beamline designed, goal: 3D imaging at 10 nm resolution), APS (dedicated instrument from summer 2007, 30 nm resolution, 20 nm in two years for users), PETRA-III (BioImaging: a double station with bioSAXS, users around 2010), DIAMOND (beamline proposal) and at the ESRF (A Madsen development of the current ID10A, CDR XPCS-CXS and T Metzger development of the current ID01 dedicated principally to materials science, CDR CDI).
- Only X-rays can give 10 nm resolution from big (micron and larger) complexes and thick samples.

An important consideration from the timescale point of view is that the **MX-BIB** project development should start now. In five years' time the technique will either be already successfully used by all other synchrotrons and the ESRF will have lost its world leading position or CDI on biological systems will have been found to be nice in theory but insurmountable experimental difficulties will have left the technique to the domain of materials science. A road map for instrument and experimental developments, along with appropriate resources, must be created immediately to allow a proper risk assessment to be made.

Technical considerations

The main beamline characteristics derive from the requirements of having:

- A coherent X-ray beam (both temporally and spatially);
- A spatially homogeneous beam;
- A high photon flux at the sample position.

These constraints imply the choice of an undulator on a low beta section of the ring as a source (with canted undulators to allow the second branch to be used as a tuneable MX beamline, CDR MX-MAD2), with the experimental station far (> 50 m) from the source. In order to preserve the coherence properties, no optical elements will be introduced until the silicon and/or diamond monochromator in Bragg geometry separated from vacuum of the machine by a polished beryllium window.

Support facilities

Sample preparation, storage and handling facilities will be important for the success of this beamline. Close collaboration and proximity to the molecular biology facilities and sample preparation within the Partnership for Structural Biology will benefit the end-station without incurring additional costs for the ESRF.

References

- Betzig E., Patterson G.H., Sougrat R., Lindwasser O.W., Olenych S., Bonifacino J.S., Davidson M.W., Lippincott-Schwartz J, and Hess H.F. (2006), Imaging Intracellular Fluorescent Proteins at Nanometer Resolution, *Science*, **313**, 1642-1645.
- CCP4 Study Weekend (2007), Crystallography of complexes, *Acta Cryst D*, **63**(1) and articles therein.
- Grünewald K., Desai P., Winkler D.C., Heymann J.B., Belnap D.M., Baumeister W., and Steven A.C. (2003), Three-Dimensional Structure of Herpes Simplex Virus from Cryo-Electron Tomography, *Science*, **302**, 1396-1398.
- Miao J., Hodgson K.O., Ishikawa T., Larabell C.A., LeGros M.A., and Nishino Y. (2003), Imaging Whole *Escherichia Coli* Bacteria by Using Single Particle X-ray Diffraction", *Proc. Natl. Acad. Sci. USA*, **100**, 110-112.
- Nicastro D., McIntosh J.R., and Baumeister W. (2005), 3D structure of eukaryotic flagella in a quiescent state revealed by cryo-electron tomography, *Proc. Natl. Acad. Sci. USA*, **102**, 15889-15894.
- Robinson K. and Miao J. (2004), Three Dimensional Coherent X-ray Diffraction Microscopy, *MRS Bulletin*, **29**, 177-181.

MX-MAD1 and MX-MICROFOCUS: Macromolecular Crystallography using Multi-Wavelength Anomalous Dispersion and Microfocus

Summary

The canted beamline ID23 was constructed in two phases over the period 2002 to 2005. The beamline consists of two independent state-of-the-art stations for macromolecular crystallography (MX) using a canted undulator setup: one (ID23-1) is a MAD end-station, the other (ID23-2) being dedicated to microfocus experiments at fixed energy. ID23-1 (Nurizzo *et al.*, 2006) first took users in October 2003 and ID23-2 in November 2005. The two beamlines have already produced excellent results (Matsuura and Stewart, 2004; Remaut *et al.*, 2006; Marquez *et al.*, 2007; Niemann *et al.*, 2007). The evolution of these beamlines as part of the Upgrade Programme has therefore been planned as a continuation of the existing beamlines with the aim of producing consistent high throughput, high flux measurements in a user friendly and reliable environment.

Upgrades to the beamline would include:

- Extending the energy range of ID23-1 (MAD) to higher energies;
- Additional optimisation of the ID23-1 (MAD) station to improve operation at low energies, to allow, for example, more sensitive sulphur and phosphorus phasing (see also CDR MX-MAD2);
- Adding a revolver undulator system to allow both high and low energy X-rays to be sourced at high brilliance for ID23-1 (MAD);
- Extending the ID23-2 microfocus beamline to allow higher demagnification and the alternate production of 5 μm or 1 μm beam to suit experiments as required;
- Adding an ultra-high precision diffractometer to ID23-2 (microfocus) for the 1 μm beam option above.

Scientific case

Overview

Synchrotron radiation has been a driving force in making MX *the* technique for providing details of macromolecular structures at close to atomic resolution. Today ID23 consists of a beamline for the determination of unknown protein structures using AD techniques and a microfocus beamline providing routinely a beam of dimensions 7 x 5 μm^2 . The latter

beam allows experimenters to derive the best possible diffraction data from very challenging and small crystals, from the better parts of larger samples or the use of a "multi-shot" approach in order to obtain a complete data set from a large, radiation sensitive crystal (Marquez *et al.*, 2007).

As part of the Upgrade Programme, the MAD end-station will be modified to increase its energy range beyond 20 keV to give a full spectrum between 5 keV and 40 keV with a mini-focus beam (~50 μm). The current energy range already allows experimenters to determine protein structures using anomalous signals from almost all heavy atoms. The availability of higher energy photons would allow data collection to a very high resolution (better than 0.5 \AA) as well as the targeting of the K anomalous absorption edges of elements such as xenon and iodine for structure solution.

A general trend observed over the last few years is that users come to the beamline with smaller and smaller crystals. It is now common to collect good quality data sets on samples of 50 x 50 x 10 μm^3 and scientists tackling more and more projects centred on large (MDalton) macromolecular complexes will only serve to increase this tendency. The microfocus station will remain fixed energy (~14 keV) but will be developed to have both microfocus and nanofocus capabilities. The aim will be to produce a beamline fully dedicated to MX with a 5 μm diameter beam for routine operation, as now, and additionally a reduced (focused) to 1 μm diameter (or less) beam for the most challenging samples. Obtaining a full data set from one single micro- (or nano-) crystal being probably impossible, the beamline will also provide the capability to screen microcrystals (this could also be carried out on the end-stations proposed for the MASSIF CDR) and to collect and merge data collected from a large number of very small samples in a minimum amount of time and in a manner that is as automated as possible. ID23-2 could also be of strong interest for experiments on non-crystalline biological samples.

Techniques

Both stations will be dedicated to MX and principally employ the techniques of MAD or microfocus. They will be equipped with the already developed highly automated ESRF MX environment.

The MAD beamline will use recent developments in low energy SAD data collection (below 7 keV) to allow the determination of 3D structures using anomalous signals resulting from sulphur or phosphorus atoms naturally present in proteins or nucleic acids. This low energy capability will supplement that envisaged on the proposed MX-MAD2 beamline. At the softer energies, high level

harmonic rejection will be accomplished by including second silicon mirror close to the sample position.

A high accuracy rotation spindle is currently under development by the ESRF Precision Engineering Laboratory in close collaboration with the ID23-2 team. The project aims to create a rotation axis with a sphere of confusion of less than 100 nm with a cold source nearby to maintain samples at cryo-temperatures. The success of the project will be essential for the microfocus beamline, amongst others, and its aim of using a 1 μm diameter beam size. The smallest samples will probably not be mounted in isolation and several of them will be located in a single container or on a single support. The beamline instrumentation should allow the identification of each individual crystal (for example by image recognition associated with UV illumination) and the collection of optimised diffraction data from these as a function of their orientation in the X-ray beam.

Context with new sources and user community

The area of X-ray diffraction from biological samples is still undergoing considerable growth. More beamlines for routine measurements are expected to come on line across Europe in the coming several years. However, the projects that many biologists are currently embarking on will result in extremely challenging samples being brought to X-ray sources; for example very small, weakly diffracting crystals of multimeric complexes. The samples will undoubtedly require tuneable and non-tuneable high intensity, highly stable and/or highly focused X-ray beams with dedicated, experienced staff, specialised facilities and auxiliary equipment to allow full structural studies to be carried out.

In addition to its own research facilities, the ESRF is situated on a unique scientific site with an advanced X-ray source co-located with a high flux neutron source (the Institut Laue Langevin and considerable support laboratories in the form of the Carl-Ivar Brändén Building and the European Molecular Biology Laboratory housing technical platforms such as crystallography and electron microscopy). The *Institut Biologie Structurale*, as a member of the Partnership for Structural Biology and located close by, has NMR and electron microscopy platforms available.

Technical considerations

The MAD beamline will benefit from an extended energy range towards both higher and lower photon energies. For this purpose the implementation of a revolver pair of undulators (a 35 mm period undulator

to provide the low energy X-rays and a 17 mm period for the high energy) would be highly desirable. A windowless optics hutch will be a great advantage in accessing the low energy range for determining structures using the anomalous signals from sulphur or phosphorus atoms.

ID23-2 has provided considerable experience in the operation of a MX dedicated microfocus beamline in a reliable, routine and regular fashion. This provides a strong foundation for the upgrade of the microfocus beamline within the MX community. There are several options for improving the already excellent performance of the beamline. These include making the beamline longer, (up to 70 m) to reduce beam divergence whilst still achieving a microfocus beam. One could also imagine a second (optional) focusing element, closer to the sample, to allow a very fine focus for some demanding experiments: thus increasing the abilities of the beamline to cover a broader focus range from 5 μm (as currently) to 1 μm (or less) in diameter. In order to improve beam positional stability, a separate temperature controlled ($\pm 0.1^\circ\text{C}$) hutch for the focusing element(s) will be mandatory.

Support facilities

- Sample preparation laboratory, data backup facilities
- Microcrystal handling (microscope, microtools)
- As part of the MX village of closely located MX beamlines, the beamlines should have direct access to samples screened using the proposed MASSIF facility. Thus support facilities for handling large numbers of sample storage dewars will also be needed.

References

- Marquez J.A., Galfre E., Dupeux F., Flot D., Moran O., and Dimasi N. (2007), The Crystal Structure of the Extracellular Domain of the Inhibitor Receptor Expressed on Myeloid Cells IREM-1, *J. Mol. Biol.*, **367**, 310-318.
- Matsuura Y. and Stewart M. (2004), Structural basis for the assembly of a nuclear export complex, *Nature*, **432**, 872-877.
- Niemann H.H., Jager V., Butler P.J., van den Heuvel J., Schmidt S., Ferraris D., Gherardi E., and Heinz D.W. (2007), Structure of the Human Receptor Tyrosine Kinase Met in Complex with the Listeria Invasion Protein InlB, *Cell*, **130**, 235-246.
- Nurizzo D., Mairs T., Guijarro M., Rey V., Meyer J., Fajardo P., Chavanne J., Biasci J.-C., McSweeney S., and Mitchell E. (2006), The ID23-1 structural biology beamline at the ESRF, *J. Synch. Rad.*, **13**, 227-238.
- Remaut H., Rose R.J., Hannan T.J., Hultgren S.J., Radford S.E., Ashcroft A.E., and Waksman G. (2006), Donor-strand exchange in chaperone-assisted pilus assembly proceeds through a concerted beta-strand displacement mechanism, *Molecular Cell*, **22**, 831-842.

MX-MAD2: Macromolecular Crystallography using Multi-Wavelength Anomalous Dispersion with Microfocus

Summary

The proposed beamline will replace the current ID29 MX MAD end-station and would be the second branch of a canted beamline. Sector ID01b could be a highly suitable location for a beamline working on coherent diffraction imaging from biological samples since it is close to the Partnership for Structural Biology with its expertise and material in sample preparation (see CDR **MX-BIB**). The second canted section of a new ID01 (ID01a) would be intended to continue and replace the very successful activity of ID29 (Ali *et al.*, 2006; Andersen *et al.*, 2006; Dong *et al.*, 2006; Seeger *et al.*, 2006; Low *et al.*, 2006) from which a wide macromolecular crystallography (MX) user community profits. The new beamline would:

- Remain a fully independent MX MAD beamline;
- Have the same high level of automation as the beamlines proposed in the other MX CDRs;
- Provide a wide energy range (5 keV to 20 keV) with a rapid tunability;
- Provide a high photon flux over the whole energy spectrum;
- Provide a focal spot size at the sample position varying between 100 x 100 μm^2 and less than 10 x 10 μm^2 ;
- Provide an improved energy band pass using a channel cut Si(311) monochromator. This will facilitate the measurement of small anomalous signals. A standard ESRF channel cut Si(111) monochromator would be used for more routine experiments;
- Complement and supplement the proposed **MX-MAD1** beamline in providing an optimal environment for diffraction data collection at low energies (*i.e.* phasing information from crystals of native biological macromolecules using sulphur SAD and experiments around the L_1 absorption edges of xenon and iodine).

As the tendency in modern macromolecular crystallography will undoubtedly involve the structure solution of larger and more complex protein structures and those of membrane proteins from smaller crystals, there will be the need to deliver a stable and highly focused beam. Derivatisation of these large and fragile complexes will become more and more difficult and thus measurements at lower energies from crystals of macromolecules will have an increased significance. We intend to provide the optimal experimental environment necessary for such experiments to be successful.

Scientific case

Overview

Large macromolecular complexes are difficult to express, purify and crystallise. The same observation applies to human and/or mammalian proteins. The currently preferred technique of structure solution in MX (*e.g.* MAD/SAD using seleno-methionyl derivatised proteins) is therefore liable to become less commonly used. Phasing with softer X-rays will help overcome this problem as experimenters will be able to exploit the presence of naturally present sulphur and phosphorous atoms to determine macromolecular crystal structures. The use of longer wavelengths also makes the use of other derivatives, such as those based upon iodine or xenon, more tractable as MAD experiments around the L anomalous absorption edges of these elements become possible.

Crystals of large protein-protein or protein-DNA complexes or membrane proteins are likely to be much smaller in size than is currently the case, to diffract more weakly and to be more susceptible to radiation damage. Using a microfocus X-ray beam will be advantageous in these cases for the following reasons:

- Matching beam and crystal sizes will increase signal-to-noise ratios thus maximising observed diffraction limits from microcrystals. The ability to rapidly change the focal spot size at the sample position rather than simply slitting the beam will be important and allow maximal flux to reach the sample whilst minimising background scatter.
- Microbeams will, in favourable cases, allow diffraction data to be collected by "walking" across the crystals thus increasing the diffraction data obtainable from radiation sensitive crystals.
- Collection of diffraction data from the best region of a poor quality crystal.

Experience to date has shown that the quality of diffraction obtained from different crystals of the same large macromolecular complex can be particularly variable. It is therefore essential that the beamline be highly automated. Sample changing robots both on the beamline and at the proposed **MASSIF** facility will allow the rapid screening and characterisation of hundreds of samples in a high throughput manner. Automatic procedures will allow the collection and online analysis of diffraction data from the best crystals and will include a feedback system that will optimise the chances of successful structure solution.

Techniques

Anomalous Dispersion (AD)

This method is the preferred technique for *de novo* structure solution in macromolecular crystallography.

It is based on the collection of (small) anomalous and dispersive signals obtained by collecting diffraction data at (several) energies around the (measured) absorption edge of an anomalous scatter introduced into crystals of biological macromolecules. The MAD technique avoids problems of phase ambiguity inherent to other structure solution techniques. The SAD technique will be especially important for structure solutions using crystals of native macromolecules. The phase ambiguity inherent in the SAD technique can be overcome using density modification protocols built into modern phasing software.

Context with new sources and user community

The upgraded beamline would be one of the most brilliant tuneable MX beamlines in the world with the additional advantage of providing an energy tuneable microbeam. This will make it well suited for challenging experiments on demanding projects (complexes, membrane proteins etc.) and/or those requiring a special experimental setup (for example long wavelengths).

Technical considerations

The upgraded beamline would make use of a channel cut silicon monochromators with both [111] and [311] cut crystals in the same vessel. Focusing would be achieved through a prefocusing mirror followed by a Kirkpatrick-Baez mirror pair to provide the final microbeam.

It is possible that a beam mimicking many of the characteristics of a microbeam could be attained on the proposed beamline simply by slitting down the current mini-focus ($\sim 50 \mu\text{m}^2$) beam. This option is certainly worth investigating and in order to assess this possibility on the current ID29: (1) a mini-diffractometer with in-built beam defining apertures would be required and (2) a revolver pair of undulators would be highly desirable in order to provide a suitable intensity for a slitted beam over the whole energy range of the beamline.

As for many of the MX beamlines included in the various MX Group CDRs (MASSIF; MX-MAD1, MX-MICROFOCUS), the full potential of this beamline would be realised only with high quality, rapid, large area 2D detectors, such as the pixel detectors currently under development.

Support facilities

- Sample preparation laboratory, data backup facilities
- Microcrystal handling (microscope, microtools)
- As part of the proposed MX village with closely co-located beamlines, the beamlines should have direct access to samples screened using the proposed MASSIF facility. Support facilities for handling large numbers of sample storage dewars will also therefore be needed.

References

- Ali M.M.U., Roe S.M., Vaughan C., Meyer P., Panaretou B., Piper P.W., Prodromou C., and Pearl L.H. (2006), Crystal Structure of an Hsp90-Nucleotide-P23/Sba1 Closed Chaperone Complex, *Nature*, **440**, 1013-1017.
- Andersen C.B.F., Becker T., Blau M., Anand M., Halic M., Balar B., Mielke T., Boesen T., Pedersen J.S., Spahn C.M.T., Kinzy T.G., Andersen G.R., and Beckmann R. (2006), Structure of Eef3 and the Mechanism of Transfer RNA Release from the E-Site, *Nature*, **443**, 663-668.
- Dong C., Beis K., Nesper J., Brunkan-LaMontagne A.L., Clarke B.R., Whitfield C., and Naismith J.H. (2006), Wza the translocon for *E. coli* capsular polysaccharides defines a new class of membrane protein, *Nature*, **444**, 226-229.
- Low H.H. and Loewe J. (2006), A bacterial dynamin like protein, *Nature*, **444**, 766-769.
- Seeger M.A., Schiefner A., Eicher T., Verrey F., Diederichs K., and Pos K.M. (2006), Structural Asymmetry of AcrB Trimer Suggests a Peristaltic Pump Mechanism, *Science*, **313**, 1295-1298.

Introduction to the Conceptual Design Reports of the Materials Science Group

The Materials Science Group presents six CDRs: EMS, HIENE, HIPRE, MATSCI, POW and TRD (see below) covering a wide range of the future demands in materials research where synchrotron radiation is needed. These future developments will provide expanded access to nanometre resolution, high photon energies, improved time resolution and the possibility for studies at non-ambient conditions, notably at higher pressures and higher/lower temperatures than are currently available. This ensemble of CDRs covers most of these challenges and forms a unified platform for future materials science research. In the nanometre regime, it is aimed to have better than 50 nm resolution (HIENE, MATSCI), energies well beyond 100 keV (EMS, HIENE, MATSCI), time resolution from 100ps to ms to sec (TRD, MATSCI, HIENE, POW, HIPRE) and high pressures up to mega bars (HIPRE). HIPRE will further provide combined high temperatures (> 6000 K) or low temperatures (4 K) in combination with the increased high pressure capability. The CDRs link with a large number of the priority areas highlighted by the ESRF Scientific Advisory Committee: *X-ray Imaging* (HIENE, MATSCI), *Nanoscience and Nanotechnology* (MATSCI, HIENE), *Pump-and-Probe and Time-Resolved Science* (TRD, MATSCI, HIENE, POW) and *Science at Extreme Conditions* (HIPRE). In addition to these highlighted areas, the CDRs address the future needs in structural and solid state chemistry (POW, MATSCI, TRD, HIPRE) and engineering science (EMS, HIENE, MATSCI, POW).

The beamlines in the Materials Science Group have always been in a state of constant evolution in order to meet the increasing needs of the users. The demand has been steadily growing and the existing beamlines are heavily oversubscribed. The Upgrade Programme will make a substantial increase in possible productivity due to upgrades and development in a number of areas. **Detectors:** Upgrades of detectors will raise the productivity by orders of magnitude. In particular, development of high energy detectors, where the efficiency is presently very low, will allow new experiments such as *in situ* studies of bulk materials of particular interest to engineers. Examples are stress/strain studies and microstructure evolution of industrial components. **High energy:** The availability of longer straight sections and new cryogenic (superconducting) undulators will expand the energy range (of particular interest to HIENE, HIPRE, MATSCI and POW). This will open up new opportunities in

studies of deeply buried interfaces (HIENE), studies of framework structures, amorphous and liquid materials by means of atomic pair distribution functions (PDFs) at ambient and high pressure and temperature conditions (POW, MATSCI, HIENE, EMS, HIPRE). A dedicated engineering station (EMS) will allow automated studies of long term fatigue (cracks etc) as well as studies of nucleation and growth phenomena critical for emerging industrial users. Examples include the possibility of high energy tomography on ms timescales (HIENE). The expanding nanomaterials science area needs suitable tools of structural characterisation in the nanoregime (50 nm and below) (MATSCI). In the high pressure area there is a need for much improved capacity, as well as the expansion into a completely new area for the ESRF, through the implementation of a multi-anvil press, which will allow a wide range of complementary studies of material properties under high pressure (ultrasonic interferometry for instance) as well as the opportunity to synthesise novel materials under non-ambient conditions through a targeted expansion of our solid state chemistry and geochemistry programmes. The study of rheological and mechanical responses under combined pressure and temperature will also be offered. In all fields, improvements in time resolution will be important. The Upgrade Programme will allow the creation of an integrated and complementary platform for Materials Science. These CDRs are furthermore connected and complementary to CDRs in the imaging and spectroscopy areas (EDXAS, INELX, NR-HE, NR-NSM, XAS-XES, etc.).

The critical components of the foreseen developments are detector development, access to higher energies and the development of engineering tools for vibration and environmental control to allow meaningful nanobeam investigations. In order to make it possible for users to fully exploit capabilities in the nanoregime it will be necessary to provide *ex situ* sample mounting, metrology and preliminary characterisation at a more precise level than is currently available. It is also foreseen that an expanded collaboration with external groups is necessary (multi-anvil press for instance) and the Upgrade Programme would provide office and laboratory space for collaborative research in order to obtain a critical mass of expertise in certain areas. The possibility of Partnerships is envisioned and a Materials Science Facility would provide a vehicle for such expansions.

Summary of individual CDRs

| | | |
|---------------|---|---------|
| EMS | Engineering Materials Science: A new dedicated station for engineering applications where automation, short term access, industrial standards and local expertise will be implemented to serve industrial users. | page 29 |
| HIENE | High Energy X-ray Beamline: New high energy undulators and detectors enhance the productivity of diffraction and imaging methods by a factor of 100 and new focusing optics by a factor of 10 enable time-resolved diffraction and imaging on the ms timescale. | page 31 |
| HIPRE | High Pressure Technique Beamlines: Increased capacity, precision, complementary and performance in extreme conditions research through evolution of the current ID27 and the creation of a joint beamline catering for the expansion of ID09A and the installation of the multi-anvil device, improved sample environment and newly developed detectors. | page 33 |
| MATSCI | Materials Science: It is proposed to build upon the evolving capabilities of ID11 in order to make multidimensional (<i>i.e.</i> , spatial, temporal and microstructural) and simultaneous hierarchical characterisation of specimens viable down to the sub 100 nm range. | page 39 |
| POW | High Resolution Powder Diffraction: Evolution of the high resolution powder diffraction beamline, with new detectors yielding a ten fold increase in counting efficiency with improved resolution, and an increased energy range up to 90 keV allowing studies on steels and superalloys and the use of more complex sample environments. | page 42 |
| TRD | Time-Resolved Diffraction and Pump-and-Probe: A dedicated beamline for pump-and-probe experiments and time-resolved diffraction aiming at the tracking of atomic motions in physical, chemical and biological systems to at least 100 picosecond resolution. Upgrades in undulator technology, X-ray optics, lasers and detectors mean the quality of excited-state structures is expected to improve substantially. | page 45 |

EMS – Engineering Materials Science

Summary

We propose to dedicate a beamline to the field of engineering materials science in order to satisfy the increasing demand for the use of high energy X-rays in the range 20 to 100 keV. This beamline operating at low maintenance and installation cost will be optimised for the energy dispersive diffraction technique using white synchrotron radiation preferably from an insertion device including, as well, a monochromatic option for texture measurements. The key advantage of this technique is that it provides high spatial information from bulk samples. This will release the increasing pressure on ID11, ID15, and ID31 and provide a prime beamline dedicated to engineering needs.

Scientific case

Overview

Modern materials engineering research based on non-destructive diffraction techniques with neutron and high-energy X-ray radiation has reached a mature state. The applications range from characterisation of the residual stress state in engineering components to the understanding of intra-granular phase transformation in metals. This provides a bridge between physics, chemistry and engineering, which governs the relationship of microstructure and materials properties and involves sophisticated material models treated with finite element methods (FEM). It is this combination which is one of the keys for the future development in this research area.

Recently the ILL, similar to other neutron facilities, decided to dedicate a full instrument – SALSA – to this field of research as a consequence of the steep

increase of interest. Several well recognised materials science and engineering (MS&E) research groups in Europe (UK, Germany, France, Spain, Austria, Czech Republic) have developed specific programs in this area of materials research applying non-destructive diffraction techniques. At present a consortium of 19 leading MS&E scientists from 13 UK major universities is proposing a continuation of the FaME38 facility, which reflects the strong interest in this field of research. A similar growth of the field is seen throughout Europe. Additionally, the new Framework Programme 7 specifically supports applied nano- and materials research in Europe during the period 2007 to 2011 with the aim of creating a knowledge based economy.

Techniques

Non-destructive diffraction techniques employing high energy X-rays provide unique possibilities into the investigation of structural properties of matter due to the combination of high penetration depth, high intensity and small beam sizes. In the white beam mode (energy dispersive diffraction) a solid state germanium detector collects simultaneously a multitude of Bragg reflections. In monochromatic mode (angular dispersive diffraction) a set of diffraction rings are collected by a 2D detector. Spatial resolution to define a small gauge volume inside the sample is achieved by special collimation systems.

A new field of research becomes accessible to characterise components from the bulk and up to the surface with very high spatial resolution down to the intra- and sub-granular levels. The different topics entering in this strongly applied research show that today this field has evolved much beyond routine 3D strain mapping and specifically makes use of the advantages evolving from high energy X-rays. Present applications include *in situ* study of phase-transformation, fracture mechanics, characterisation of friction welding techniques, characterisation of novel (light-) alloys for aerospace applications, smart materials (actuators), advanced materials (bulk metallic glasses, bio-materials, implants, nanostructured materials), materials improvement (shot peening, laser peening, carburisation/nitration, thermal barrier coatings, thin films), nuclear materials (zirconium alloys), validation of models in combination with FEM calculations to understand the physics behind complex processes.

Context with new sources and user community

At present the materials science beamlines at ESRF have a leading position in their fields of research. High energy X-rays offer unique properties combining

high penetration depth and high spatial resolution. It is this combination which attracted the user community of engineering materials research and led to the steep increase of beamtime request observed over the past five years. In Europe, at this time, only two experimental stations outside the ESRF (HARWI II at HASYLAB, EDDI at BESSY II) provide high energy X-rays, but with less flux and at less high energy. The need for beamtime cannot presently be satisfied and the ESRF materials science beamlines are heavily oversubscribed. One important limitation is the fact that the high energy beamlines operating today have to serve a wide range of research fields and are only partially available for engineering materials research.

The new upcoming third-generation synchrotron radiation sources SOLEIL (2007), DIAMOND (2007), PETRA-III (2008) and ALBA (2010) will compete with the ESRF in the energy range up to 30 keV. Beamlines for engineering materials research are only foreseen at PETRA-III (GKSS beamline) and DIAMOND (JEEP). These insertion device sources offer a higher flux than a bending magnet beamline but again they aim to serve a wider field of research.

An optimised dedicated beamline for engineering materials research even on a bending magnet can significantly contribute to alleviate the pressure on the ESRF materials science beamlines, although an insertion device would certainly be the optimal choice. The emergence of multi-element detectors or 2D pixel detectors further increases the usefulness of the ESRF sources for this kind of experiments. An important argument for a dedicated beamline is the gain using optimised, permanent setups, which reduces the down time when changing between different experiments and thus increases productivity.

The future operation of several beamlines at European synchrotrons in the field of engineering materials research will promote even further the growing interest of this user community since the reliable availability of beamtime will enhance confidence in developing more intense research programmes.

In extrapolating the evolution of this research field over the next ten to twenty years the ideal choice for a dedicated beamline would be an insertion device based station. This would open all possibilities of studying even strongly absorbing materials and large "real" components – a field which is only starting to be exploited.

Technical considerations

Both an insertion device and a bending magnet beamline will provide useful X-rays below 100 keV and allows studies of mainly low and medium density

materials such as aluminium and titanium alloys typically used in the aerospace manufacturing sector. An insertion device would be needed for high Z materials. To a large extent such a beamline can be operated in an automatic mode since the experimental setup is well defined and fairly standardised. The need to develop industrial standards is important. The energy dispersive diffraction technique only requires white beam and a system of slits combined with germanium solid state detectors at a fixed 2θ angle. For texture studies an easy to operate fixed exit bent Laue monochromator (operation in air similar to the model developed on ID15) combined with a 2D detector can be added.

A substantial increase of efficiency can be achieved by specially designed detection systems. Segmented multi-element energy dispersive detectors combined with an adapted microbeam collimator makes 3D spatially resolved diffraction patterns in only one measurement possible. Pixel detectors optimised for high energies will increase the efficiency of angular dispersive diffraction methods by orders of magnitude.

Such a dedicated beamline with an optimised, fixed installation reduces the experimental setup time leading to a more effective use of beamtime. Analysis software already exists (FaME38; based on GSAS, Los Alamos National Laboratory) which allows near-online data reduction and should be further developed (automated alignment, calibration, efficiency).

The main aspects are the gain in reliability and the repeatability of measurements with high spatial resolution in bulk samples. These are necessary conditions to increase the acceptance of the technique by industrial customers.

Support facilities

Engineering specific sample environment: maintenance and operation of stress rigs by an existing technician. Development of data analysis strategies and software for automatic operation (computing support). At present the FaME38 laboratories at ILL are available for offline preparation of experiments.

References

- Liss K.-D., Bartels A., Schreyer A., and Clemens H. (2003), High energy X-rays: A tool for advanced bulk investigations in materials science and physics, *Textures and Microstructures*, **35**, 219-252.
- Martins R.V. and Honkimäki V. (2003), Depth resolved strain and phase mapping of dissimilar friction stir welds using high energy synchrotron radiation, *Textures and Microstructures*, **35**, 145-152.
- Poulsen H.F., Wert J.A., Neufeind J., Honkimaki V., and Daymond M.R. (2005), Measuring Strain Distributions in

Amorphous Materials, *Nature Materials*, **1**, 33-36.

- Preuss M., Rauchs G., Doel T.J.A., Steuwer A., Bowen P., and Withers P.J. (2003), Measurements of fibre bridging during fatigue crack growth in Ti/SiC fibre metal matrix composites, *Acta Materialia*, **51** (4), 1045-1057.
- Pyzalla A., Camin B., Buslaps T., Di Michiel M., Kaminski H., Kottar A., Pernack A., and Reimers W. (2005), Simultaneous Tomography and Diffraction Analysis of Creep Damage, *Science*, **308**, 92-95.
- Steuwer A., Santisteban J.R., Turksi M., Withers P.J., and Buslaps T. (2004), High-resolution strain mapping in bulk samples using full-profile analysis of energy-dispersive synchrotron X-ray diffraction data, *J. Appl. Cryst.*, **37**, 883-889.

HIENE: High Energy X-ray Beamline

Summary

Research at the high energy X-ray diffraction and scattering beamlines ID15A and ID15B started in 1994 exploiting unique properties of very hard X-rays up to several hundred kilo-electronvolts. After a few years of operation many new fields of research emerged and this trend is continuing. The concept of the beamline is to keep the scientific options open and retain flexibility. At present the main areas of research are engineering materials research and studies of surfaces and buried interfaces. The X-ray optics and beamline layout are designed to operate simultaneously two independent branches: ID15A can operate with white or monochromatic beam, whereas ID15B is using monochromatic beam.

Scientific case

Overview

The future technical developments (described later) would increase the incident flux by two orders of magnitude for certain experiments. Furthermore, high energy detector developments could give one order of magnitude more. Ultra-fast high resolution microtomography will allow time-resolved studies of systems evolving on few tens of millisecond timescale. This enables studies on, for example, the dynamic properties of granular materials and phase transitions/kinetics of colloidal crystals and glasses (van Blaaderen, 2006; Velikov *et al.*, 2002; Leunissen *et al.*, 2005). The combined time-resolved microtomography and angular dispersive X-ray diffraction will provide information about the evolution of morphology, texture, phase, microstructure and the stress state in materials processing with the same time resolution. The possible

applications are numerous including the phase transformation studies in metallic and smart materials, characterisation of crack growth and propagation, *in situ* characterisation of novel materials in harsh environments, *in situ* studies of bulk metallic glasses, bio-materials, implants, nanostructured materials, etc.

The high energy X-ray micro diffraction instrument offers a unique opportunity to couple synchrotron surface diffraction/scattering techniques and atomic force microscopy (AFM), which is among the most rapidly expanding of nanoimaging techniques. Furthermore, the capabilities of the instrument will be extended towards the small scattering angles in order to detect signatures of nanoparticle superlattice formation. These developments would allow the ID15 beamline to act at the forefront of the rapidly expanding fields of nanoscience and nanotechnology. Scientific and technological issues that will become accessible include (i) *in situ* formation of large area nanocrystal monolayers on various surfaces, (ii) creation of thin films of binary nanocrystal superlattices, (iii) search for nanowetting-induced superlattice phase transitions and investigation of their kinetics, (iv) modification of self-assembly processes by substrate physical or chemical nanopatterning, (v) superlattice nanowetting with binary liquids, (vi) solvent quality effects and possible role of Casimir forces, (vii) nanocrystal thin films buried between two solid surfaces and their controlled nanowetting, etc. (Shevchenko *et al.*, 2006; Rogach, 2004; Narayanan *et al.*, 2004; Ohara. *et al.*, 1995; Kiely *et al.*, 1998).

Techniques

ID15A is equipped with an energy dispersive diffraction setup, an ultra-fast microtomography setup, a spin resolved in-elastic scattering setup and a surface/interface diffraction setup. In addition the large floor of the experimental hutch enables any new high energy applications considered important for the further extension of the in-house and external users' research programmes to be exploited. In the future, the imaging and energy/angular dispersive diffraction setups will be combined as one permanent setup. The microbeam diffraction setup for surface/interface studies will be extended to allow high energy time-resolved wide and small angle scattering experiments with 2D detectors. The shorter X-ray wavelength has the disadvantage of shifting the small angle scattering signal to even smaller angles. On the other hand, the large radius of the Ewald sphere enables the acquisition of highly time-resolved diffraction maps. The atomic force microscopy would provide simultaneous acquisition of local high resolution real-space images of the surface under study.

ID15B is equipped with both a high resolution inelastic scattering setup and a 2D diffraction setup for the studies of single crystals (including diffuse

scattering), powders, amorphous materials and liquids. A unique spatial resolution in strain/stress studies is achieved by different focusing techniques and special collimation systems such as a spiral slit. Future improvements would make it possible to acquire both time and 3D space resolved diffraction maps.

Context with new sources and user community

With the exception of PETRA III the new synchrotrons across Europe will operate at lower energy than at the ESRF. Therefore, ID15 will continue to be a unique beamline exploiting high energy X-rays. Furthermore, due to the high over subscription of ID15, the ESRF should consider building new dedicated high energy beamlines.

Technical considerations

The most important areas for the future technical developments in the high energy X-ray fields are (i) cryogenic or short periodic superconducting undulators, (ii) focusing techniques and (iii) more efficient detectors for high energies. The combination of these three ingredients could increase the detected signal even by three orders of magnitude.

In the near future ID15 will make use of an in vacuum undulator in addition to the current asymmetric multipole wiggler. Below 100 keV the increase of the incident flux will be around a factor of ten. Cryogenic undulators and technically challenging short periodic superconducting undulators will give even bigger increase of the flux at high energies.

The development of focusing multilayer optics and compound refractive lenses with larger acceptance (already under development) will increase the flux at the sample by one order of magnitude. In future the optics based on bent Laue crystals can be replaced by small band-width focusing multilayer optics. The optics hutches of ID15A and ID15B would have to be reconstructed to take full advantage of these developments.

Special segmented multi-element energy dispersive detectors combined with an adapted microbeam collimator enable 3D spatially resolved diffraction patterns to be recorded at very high energies in one measurement. Pixel detectors optimised for high energy X-rays would increase the detection efficiency of angular dispersive diffraction methods by a factor of ten. The imaging-diffraction setup can be improved in terms of both temporal and spatial resolution using highly efficient structured scintillators (already under development) and multi-tap CCD sensors.

The combination of all these developments will make it possible to collect a complete high resolution tomographic dataset in a few tens of milliseconds.

Atomic force microscopy can be coupled to the high energy microdiffraction instrument because the entire X-ray reflectivity data collection can be performed without moving the sample (liquid surface spectrometer operation mode). This will eliminate possible disturbances of the AFM operation in the case of simultaneous acquisition of reflectivity profiles, 2D-diffraction patterns and local high resolution real space images of the surface under study. The surface/interface diffraction capabilities will be extended to allow high energy time-resolved wide and small angle scattering experiments with 2D detectors.

References

- Kiely C.J., Fink J., Brust M., Bethell D., and Schiffrin D.J. (1998), Spontaneous ordering of bimodal ensembles of nanoscopic gold clusters, *Nature*, **396**, 444-446.
- Leunissen M.E., Christova C.G., Hynninen A.P., Royall C.P., Campbell A.I., Imhof A., Dijkstra M., van Roij R., and van Blaaderen A. (2005), Ionic colloidal crystals of oppositely charged particles, *Nature*, **437**, 235-240.
- Narayanan S., Wang J., and Xiao-Min L. (2004), Dynamical self-assembly of nanocrystal superlattices during colloidal droplet evaporation by *in situ* small angle x-ray scattering, *Phys. Rev. Lett.*, **93**, 135503.
- Ohara P.C., Leff D.V., Heath J.R., and Gelbart W.M. (1995), Crystallization of Opals from Polydisperse Nanoparticles, *Phys. Rev. Lett.*, **75**, 3466-3469.
- Rogach A.L. (2004), Binary superlattices of nanoparticles: Self-assembly leads to "metamaterials", *Angewandte Chemie-International Edition*, **43**, 148-149.
- Shevchenko E.V., Talapin D.V., Kotov N.A., O'Brien S., and Murray C.B. (2006), Structural diversity in binary nanoparticle superlattices, *Nature*, **439**, 55-59.
- van Blaaderen A. (2006), Materials science - Colloids get complex, *Nature*, **439**, 545-546.
- Velikov K.P., Christova C.G., Dullens R.P.A., and van Blaaderen A. (2002), Layer-by-layer growth of binary colloidal crystals, *Science*, **296**, 106-109.

HIPRE: High Pressure Technique Beamlines

Summary

In line with the recommendation of the last review of the beamlines (May 2006) we propose to make ID09A a full beamline dedicated to diffraction experiments using diamond anvil cells on one canted undulator

branch of a low- β straight section. The second branch will become the final location of the large volume press and for the Paris-Edinburgh press total scattering diffractometer, presently being developed at ID27. ID27, which has just been constructed and requires an uncompromised, maximum brilliance beam, will continue to operate in its present form, except for usual upgrades as source, optic and experimental technologies advance.

The proposed project will improve the ESRF infrastructure by providing two fully dedicated straight sections for high pressure experiments. This will ensure the ESRF's position as the foremost source for data collection at extreme conditions of any of the third-generation synchrotrons. The operation of three independent beamlines will double the beam time available to users and offer a more diverse portfolio of techniques, adapted to specific user requirements. As a direct consequence, new and very challenging scientific projects will become possible.

Scientific case

Overview

The need for experimental investigations of fundamental structural, physical, and chemical properties of condensed matter at extreme conditions of pressure and temperature has expanded tremendously over the last decade. Related experimental results not only provide new insights into as yet unpredictable behaviour, but also form the basis for modelling structure, dynamics and reactivity using rapidly developing theoretical approaches. A solid theory grounding is essential for predicting behaviour at conditions not accessible in the laboratory. The immediate impact is in Earth sciences and planetary modelling, as well as understanding processes in man made extreme conditions realised on short timescales. At present, the ESRF is Europe's only facility providing all of the technical and methodical ingredients needed for truly extreme conditions research. It is highly desirable that, through increased capacity at the ESRF, it will be ensured that for the next decade or so European science can continue to play a leading role in combined high pressure/low and high temperature research.

X-ray diffraction, which provides the essential structural information for understanding physical properties of matter, will remain the most widely used experimental technique to study crystalline, liquid, disordered or nanoscale materials under extreme pressures and temperatures. ID09A and ID27 are world leading beamlines designed to determine structural properties of matter at extreme conditions with the greatest accuracy possible using monochromatic diffraction and large area imaging detectors. The

complementary specialities of ID09A and ID27 make the ESRF the primary source for high pressure expertise and experimentation. Beamlines ID09A and ID27 are highly productive and competitive with beamlines in Japan (SPRING-8) and the US (HPCAT and GSECars). The research produced is of the highest ranking, judging by the ratio of publications to experiments and the number of papers appearing in top ranked journals. Both beamlines are major resources for European physics, structural chemistry, structural biology, materials science and earth science communities. The imminent purchase of a large volume press (LVP) will increase the ESRF's repertoire in an area in which it is not currently competitive with Japan and the US. The LVP is planned to be in temporary operation at ID06.

ID09A is, and has been for the last ten years, the leading beamline for high pressure studies at ambient and low temperatures with additional Raman and laser annealing facilities. From the outset, challenging and previously impossible experiments have been performed. The equation of state of hydrogen has been measured to megabar pressure (Loubeyre *et al.*, 1996). The transition from energy dispersive to monochromatic diffraction allowed the characterisation of more complex structural changes. The oC16 structure of Cs (Schwarz *et al.*, 1998) and Si (Hanfland *et al.*, 1999) was determined, fundamental for understanding the complex behaviour of some elemental solids at high pressure observed in more recent experiments. Improvements in focusing optics resulted in smaller and better defined beams, helping to solve the long standing mystery of predicted but never previously observed polymeric phases of nitrogen at high pressures (Eremets *et al.*, 2004). Besides the continuous development of the beamline, the available flux was increased more than ten fold by upgrading to more efficient insertion devices, a new diffractometer providing more accuracy and stability is about to be installed and key developments in sample environment were made by in-house staff to keep the facility at the forefront of high pressure science. A cryostat allowed the experimental verification of theoretically predicted symmetry breaking in light alkali metals at high pressures (Hanfland *et al.*, 2000). A gas loading system for using helium as quasi hydrostatic pressure transmitting medium made possible the study and refinement of incommensurate structures at megabar pressures (Hejny *et al.*, 2005). Helium as the pressure transmitting medium at low temperatures has also allowed investigations into the role of subtle structural changes in known physical phenomena such as the Verwey transition (Rozenberg *et al.*, 2006). Experiments are becoming possible that have never been performed before. The behaviour of large unit cell, low symmetry organic superconductors, including structural phase transitions, can be studied to unprecedented pressures (Hanfland and Müller, 2006) by single crystal diffraction.

Aside from the increase in available beam time through canted operation, the new beamline will profit from the development of new detector technologies. New detectors with faster readout and recent developments such as computer-controlled pressure controllers allow new types of experiments. Real time data collection, while pressure and/or temperature are changing, permits well-controlled *in situ* monitoring of intermediate states or phases, essential for understanding the formation of new metastable materials that are expected to be of technological interest. Mechanisms of pressure or temperature induced phase changes can be studied in detail, presently of considerable theoretical interest (*e.g.* Catti, 2005) but experimental investigations are rare. With a higher dynamic range than presently available the total elastic scattering signal from the sample (Bragg reflections and diffuse scattering between the reflections) can be collected, to derive simultaneously structural and dynamical properties of matter under pressure to give insight into, for example, pressure-induced amorphisation, fast ion conduction, quasi-crystals etc.

The continuous development of the beamlines will go hand-in-hand with the improvement of the high pressure sample environment. A new cryogenic system will be developed; a cryostat with a tailored diamond anvil cell and gas loading system, for diffraction measurements down to 4 K and below. The role of structure in critical phenomena at low temperatures, like superconductivity, can therefore be investigated. The number of elements known to become superconductors at high pressure is constantly increasing, some with surprisingly high critical temperatures (Deemyad and Schilling, 2003). New types of high T_c superconductors have also been predicted theoretically at high pressures (Feng *et al.*, 2006).

The newly built ID27 caters for very small samples and multi-megabar pressures combined with very high temperatures using a unique double-sided *in situ* laser heating facility. In addition, ID27 is a unique centre for experiments using the Paris-Edinburgh press, which has no equivalent elsewhere.

Experiments conducted with the Paris-Edinburgh press are unrivalled in the quality of its diffraction, due largely to the in-house development of an oscillating slit assembly (Mezouar *et al.*, 2000) leading to the use of data collection in angle dispersive mode. These experiments, conducted at pressures exceeding 15 GPa through the recent upgrade to sintered diamond anvils, have allowed more advanced characterisation of materials under high pressure and temperature conditions. These include the *in situ* determination of the high pressure and high temperature structures of sulphur and their relative stabilities (Crichton *et al.*, 2001; Crapanzano *et al.*, 2005), the structure and dynamics of fast ion halides (Keen *et al.*, 2003) and

rotator phases from combined calculation and total scattering methods (Parffitt *et al.*, 2005). *In situ* investigations of the subtle effects of cation order-disorder and the influence of cation site occupancies on phase stabilities in spinel and carbonate systems have also been conducted (Antao *et al.*, 2004, 2005), as well as kinetic measurements on the dehydration processes in antigorite, which are thought to be central to earthquake production (Perrillat *et al.*, 2006). All of these experiments are not possible in diamond anvil cells, either because of temperature limits, or the comparatively low signal/background ratio that results from the Compton scattering of diamond. More recently, because of the availability high precision, low background data that can be collected using this system, increasing numbers of studies have been conducted on the studies of glasses, liquids and other systems displaying low scattering diffuse diffraction phenomena. These have included the study of the "(probable) first-order transition (Mei *et al.*, 2006)" in liquid GeSe_2 at high pressure (Crichton *et al.*, 2001), the amorphisation process in the negative thermal expansion material ZrW_2O_8 and studies on the kinetic of growth of nanocrystalline "clusters" in bulk metallic glasses (Zhuang *et al.*, 2000), which result in a stronger material, without loss of inherent flexural properties. The success of the Paris-Edinburgh facility at the ESRF means that there are indeed many similar projects being undertaken at other synchrotrons; particularly at the APS, where recent work using a Paris-Edinburgh device shows how powerful this technique is for total scattering and pair-distribution analysis (*e.g.* Mei *et al.*, 2006). We now propose to extend our own capabilities by using a new geometrical setup, which has been recently built and tested to further enhance the ESRF's position within this field and propose that a second hutch at a low beta sector (for example ID13B) be dedicated to this emerging field in which the ESRF has been identified as a world leader.

If we consider the extension of the current large volume experimentation and equipment to include the future high force multi-anvil device to be installed at ID06, we can see that its future lies in more applied studies. The combined *in situ* determination of both the X-ray diffraction structure and the physical properties (*e.g.* rheological response, elasticity etc.) of materials under high pressure and temperature conditions is of immense interest to all communities. Access to high pressures (up to and exceeding 50 GPa) with high, stable and directly measurable temperatures complements excellently high pressure diamond anvil cell over the same pressure range. It is in this regime that large volume multi-anvil devices excel. The large, accessible sample chamber can lead to more sophisticated environments and experiments through the use of stepped internal furnaces, cryosystems, probes, redox buffers, thermocouples, electrical lead-throughs etc that result in a versatile, controllable and measurable system. The large sample chamber also provides the base for

experiments where considerable volume is a prerequisite, *e.g.* ultrasonic interferometry. Moreover, the use of large volumes ensures stable and controllable temperature, pressure and chemical gradients, which is difficult – if not impossible – to obtain by any other method at similar pressures. With a device such as this, many transport properties of materials can be studied *in situ*; including, diffusivity, viscosity, nucleation rates and growth kinetics and the results can be applied to any scientific or industrial domain, for example, in the synthesis of ultra-hard materials (*e.g.* Solozhenko *et al.*, 2002; Dubrovinskaia *et al.*, 2005).

Recent developments (at the APS, NSLS and elsewhere) in the operation of large volume, multi-anvil devices allow the study of samples under variable differential stress environments (*e.g.* Durham *et al.*, 2002; Wang *et al.*, 2003). These devices are used for the extraction of mechanical (yield stress, Poisson's ratio, Young's modulus, etc, see Chen *et al.* 2004; Li *et al.* 2004) and thermodynamic information (density, elastic tensors, bulk modulus, etc) from materials as a function of both applied pressure and temperature. The combination of these isothermal measurements with adiabatic MHz ultrasonic data collections leads to complete characterisation of the response of any material – crystalline or amorphous solid or liquid – as a function of applied pressure and temperature. It is in this way, through the combination of complementary and overlapping techniques, that a comprehensive understanding of any system, be it in solid state chemistry or geophysics, can be achieved.

Future development of ID27 should take advantage of its in built flexibility; with energy tunability from 6 to 100 keV, an optimum spot of 2 micrometres and flux from two in vacuum undulators, ensuring that it has the necessary beam characteristics in order to match the most challenging scientific problems. These needs have been excellently illustrated in two recent, novel, experiments on the determination of melting curves at multi-megabar pressures using combined laser-heating and sub-second X-ray diffraction and optimised X-ray emission spectroscopy with laser heated diamond anvil cells. Indeed, the accurate determination of melting curves is of fundamental interest in different research areas such as physics and geophysics. For instance, the determination of the melting curve of iron is necessary to determine the temperature at the Earth's inner-outer core boundary position (estimated through calculation to be 5650 K +/- 600 K, though the melting temperature of pure iron at the same pressure is expected at 6350 K +/- 600 K; *e.g.* Alfé *et al.*, 2003). The classical experimental methods; *i.e.* optical measurements in the laser-heated diamond anvil cell and shock compression methods suffer from intrinsic limitations that result in large temperature discrepancies. For iron, the temperature discrepancy is of the order 2000 K at 2 megabar (Boehler 1993; Brown and McQueen, 1986). A completely new

approach, which was recently tested at beamline ID27, is based on the fast *in situ* X-ray diffraction data collection from the double sided laser heated diamond anvil cell. This new method presents the advantage over the techniques cited above that it is sensitive to the bulk of the sample, the measurements are performed using well established pyrometric methods. This is the only method that offers an unambiguous signature of the melt at the thermodynamic equilibrium. The typical timescale of the melting process in the diamond anvil cell is of the order of one second or less. Therefore, such experiments require the maximum flux from the two ID27 in vacuum undulators and will certainly benefit from the future machine upgrade to run at 300 mA ring current.

Another very challenging experiment is in the simultaneous collection of X-ray emission spectroscopy (XES) and XRD data. XES is well suited to probing the existence of the local high-spin or low-spin state in transition metals and transition metal compounds under high pressures in a diamond anvil cell. XES at beamline ID16 has been applied very successfully to the study of pressure induced high-spin to low-spin transitions in iron containing materials such as wüstite (FeO) or hematite (Fe₂O₃) providing a deeper understanding of magnetic and electronic properties of important planetary materials at high pressures (*e.g.* Badro *et al.*, 2003). However, the effects of temperature (at high pressures) have been only restricted to thermodynamic calculation. A successful attempt to couple the laser heated diamond anvil cell to XES have been made at the GSECARS sector at the APS but only at low X-ray energy ($E < 15$ keV) which is a strong limitation for the collection of high quality XRD data in the diamond anvil cell. A similar setup has been installed at beamline ID27 (in collaboration with ID16) to perform experiments at higher X-ray energy ($E > 30$ keV) in order to couple the XES measurements to optimised XRD. The feasibility tests at ID27 were extremely positive, simultaneous high pressure-high temperature ($P > 30$ GPa; $T > 1800$ K) XES and XRD of iron data have been collected. The typical collection time was of the order of three hours to obtain good XES profiles. This kind of experiment will also greatly benefit from the machine upgrade.

From these two examples, it is clear that ID27 will be complementary to ID13 for the experiments that are clearly flux limited and that require the very high mechanical stability, which comes from the specially designed facility at ID27, as well as small focusing to reduce pressure and temperature gradients in the X-ray observed spot. Therefore, any upgrade of ID27 should ensure continuity with its current philosophy, taking advantage of advancing in source, sample environment and optical technologies to remain at the pre-eminent high pressure beamline in the world for particularly challenging experiments and extending the envelope of current pressure,

temperature and measurement limits. One exciting future thematic would naturally be to search for experimental evidence supporting Ashcroft's predicted new state of matter: *metallic superfluids* – proposed to be observable in hydrogen just beyond the limit of current experimental capabilities (in excess of 400 GPa, compared to the current experimental limit of 320 GPa; see Babaev *et al.*, 2005).

Techniques

ID09A evolution to a full beamline (for example on ID13a as a canted line)

Pending major technological breakthroughs, this station would continue to use monochromatic diffraction with large area detectors on single crystals and powdered samples at high pressures in diamond anvil cells.

- It would provide variable beam sizes down to less than $10 \times 10 \mu\text{m}$, to study samples from a few GPa to approximately 150 GPa, energies between 30 and 50 keV and very high photon fluxes of $\sim 10^{13}$ photons/sec.
- It would continue to offer state of the art optical systems for additional *in situ* characterisation of the samples at high pressure (Raman, etc.).
- In addition it will offer improved sample environment and both a better temporal and spatial resolution through the use of new and improved area detectors.

Large volume press (for example located on ID13b as the second canted branch)

The creation of a large volume facility on a full time canted beamline branch would give the high pressure community a unique tool for complementary studies in various scientific domains. This instrument will be particularly well suited to chemistry and geosciences and provide a significant increase of beam time to important areas currently underdeveloped at the ESRF. This highly versatile device can give users the opportunity to combine X-ray measurements with sophisticated sample environments; for example, by using redox buffering with designer furnaces and multiple temperature probes for enhanced control of chemical and temperature gradients in crystallisation studies, at an industrial scale.

Static X-ray diffraction investigations can also be combined with ultrasonic wave velocity and rheological measurements for comprehensive mechanical and thermodynamic properties measurement.

The integrated approach to data collection available with the LVP complements the ESRF's well established diamond anvil cell and Paris-Edinburgh press repertoire well, which, when taken together would emphasise the observable effects of pressure and temperature and the interrelation between changes in density, interatomic potential, bond lengths, elasticity, electronic properties, magnetic state and transport properties in all sample types.

ID27 Upgrades

We will upgrade the ID27 source to the most recently developed cryogenic or superconducting undulator to obtain the maximum flux from the ESRF machine after its upgrade. This very high flux beamline will provide new approaches to very challenging problems such as:

- The search for a new metallic superfluid state of matter predicted at pressures above 400 GPa;
 - The determination of melting lines and melt structures of light elements at extreme pressures.
- The beamline optics will be modified to accommodate new complementary techniques:
- To perform ultrahigh pressure and temperature X-ray emission spectroscopy in combination with X-ray diffraction in the laser heated diamond anvils (EH2);
 - To combine high pressure X-ray diffraction and XAS studies with the Paris-Edinburgh presses (EH1) in fluorescence mode.

Context with new sources and user community

Generally, as the number of extreme condition beamlines at new synchrotrons increases, so the number of groups gaining access to beamlines will follow. These "new" users will be attracted to the unique features of the ESRF high pressure beamlines. Consequently, there will be continued and augmented interest in the ESRF's unique high pressure programmes.

Technical considerations

As a consequence of the success and complementarities of the beamlines, they are increasingly oversubscribed. In addition, the key developments such as helium gas loading, cryostats, laser heating, oscillating slit system, etc. increases the requests for beamtime for novel experiments. At present, ID09A is sharing a straight section and beamtime with ID09B that is dedicated to ultra-fast time-resolved diffraction. ID27 is a fully dedicated beamline on its own straight section. The construction of a second beamline dedicated fully to diamond anvil cell diffraction on one branch of a canted undulator straight section will increase the beam time for user experiments provided by the existing facilities from ~300 to ~400 shifts per period. Another 200 shifts will become available by installing the new multi-anvil device and the Paris-Edinburgh total scattering facility on the second branch. By increasing the number of straight sections for high pressure science from 1½ to 2 we will therefore be able to offer double the number of shifts for user experiments.

With regards to the previously proposed upgrades to the high pressure beamlines, the Beamline Review Panel (May 2006) explicitly suggested the following:

- That management should address the current problem of oversubscription at ID09A and ID27.
- That two dedicated HP beamlines be built for DAC and P-E research. In addition, the LVP should be developed on a new beamline.
- Improved large area detectors with fast read out time and high dynamic range are required,
- Extension of low temperature capabilities to sub 1 K should be investigated.
- That a permanent position should be made to lead the LVP project
- A HP Beamline Operation Manager post should be created – independent of any assignment of staff to the LVP project.

A new type of detector with the following characteristics will be needed: large area, high resolution (*e.g.* 50 x 50 cm with 5000 x 5000 pixels), as high a dynamic range as possible (>16 bit), fast readout (10 ms), energy resolution for suppression of the inelastic background, no crosstalk between pixels. Pixel detectors are being developed to achieve this kind of performance. To work at high energies (> 30 keV) the detectors needs GaAs, or similar, conversion layers.

The necessary small beam sizes are easier achieved on low- β sections. We have no need for a long beamline to enhance focusing capabilities.

At present ID09A uses an asymmetrically cut bent Laue monochromator (Schulze *et al.* 1998). The monochromator combines high flux with a small horizontal focus (< 10 μ m). On the new canted beamline the deviation of the beam by the monochromator, in addition to that resulting from canting (~5 mrad.) will provide the necessary distance between sample stage and detector (at ~45 m from the source) and the beam tube for the second station, either within current experimental hall building (at ~ 75 m) or in existing external hutches. The (proposed) ID13A and ID13B beamlines would share a common optics hutch, located close to EH1, housing both the EH1 mirror and the channel cut monochromator for the multi-anvil device. The use of moderate length beamlines on a low- β section in canted configuration has advantages for imaging applications, where a beam size of ~2 mm (h) x ~1mm (v) will be available through natural divergence. Applications requiring high flux and resolution will require additional focusing optics (to 0.1 mm), through large multilayer KB pairs or an adaptive compound refractive lens assembly, such as the transfocator installed at ID11, for use over a wide range of photon energies.

Support facilities

Specialised high pressure sample preparation laboratories for diamond anvil cell preparation, for multi-anvil and Paris-Edinburgh sample preparation, for the gas loading facilities, a dedicated machine shop and optical labs for housing laser annealing system, laser cutting device and Raman facilities.

In addition, the Sample Environment Service will provide all other necessary equipment for user groups, particularly those requiring diamond anvil cell equipment.

References

- Alfé D., Gillan M.J., and Price G.D. (2003), Thermodynamics from first principles: temperature and composition of the Earth's core, *Mineralogical Magazine*, **67**, 113-123.
- Antao S.M., Mulder W.H., Hassan I., Crichton W.A., and Parise J.B. (2004), Cation disorder in dolomite, $\text{CaMg}(\text{CO}_3)_2$, and its influence on the aragonite plus magnesite \leftrightarrow dolomite phase boundary. *American Mineralogist*, **89**, 1142-1147.
- Antao S.M., Hassan I., Crichton W.A., and Parise J.B. (2005), Effects of high pressure and high temperature on cation ordering in magnesioferrite, MgFe_2O_4 , using *in situ* synchrotron x-ray powder diffraction up to 1430 K and 6 GPa, *American Mineralogist*, **90**, 1500-1505.
- Badro J., Fiquet G., Guyot F., Rueff J.P., Struzhkin V.V., Vanko G., and Monaco G. (2003), Iron partitioning in Earth's mantle: Towards a deep lower mantle discontinuity, *Science*, **300**, 789-791.
- Babev E., Subdo A., and Ashcroft N.W. (2005), Observability of a projected new state of matter: A metallic superfluid, *Phys. Rev. Lett.*, **95**, 105301.
- Boehler R. (1993), Temperature in the Earth's core from melting point measurements of iron at high static pressures, *Nature*, **363**, 534-536.
- Brown J.M. and McQueen R.G. (1986), Phase transitions, Grüneisen parameters and elasticity for shocked iron between 77 GPa and 400 GPa, *J. Geophysical Research*, **91**, 7485-7494.
- Catti M. (2005), Kinetic mechanisms of the pressure-driven phase transitions of AgI, *Phys. Rev. B*, **72**, 064105.
- Chen J., Li L., Weidner D.J., and Vaughan M. (2004), Deformation experiments using synchrotron X-rays: *in situ* stress and strain measurements at high pressure and temperature, *Physics of Earth and Planetary Interiors*, **143-144**, 347-356.
- Crapanzano L., Crichton W.A., Monaco G., Bellissent R., and Mezouar M. (2005), Alternating sequence of ring and chain structures in sulphur at high pressure and temperature, *Nature Materials*, **4**, 550-552.
- Crichton W.A., Vaughan G.B.M., and Mezouar M. (2001), *In situ* structure solution of helical sulphur at 3 GPa and 400°C, *Zeitschrift für Kristallographie*, **216**, 417-419.
- Crichton W.A., Mezouar M., Grande T., Stolen S., and Grzechnik A. (2001), Breakdown of intermediate-range order in liquid GeSe_2 at high pressure, *Nature*, **414**, 622-625.
- Deemyad S. and Schilling J. S. (2003), Superconducting phase diagram of Li metal in nearly hydrostatic pressures up to 67 GPa, *Phys. Rev. Lett.*, **91**, 167001.
- Dubrovinskaia N., Dubrovinsky L., Crichton W.A., Langenhorst F., and Richter A. (2005), Aggregated diamond nanorods, the densest and least compressible form of carbon, *Applied Physics Letters*, **87**, 083106.
- Durham W., Weidner D.J., Karato S., and Wang Y. (2002), New developments in deformation experiments at high pressure. In Wenk, R. (ed) *Plastic Deformation of Minerals and Rocks*. Mineralogical Society of America, Washington D.C., pp. 291-329.
- Eremets M.I., Gavriluk A.G., Trojan I.A., Dzivenko D.A., and Boehler R. (2004), Single-bonded cubic form of nitrogen, *Nature Materials*, **3**, 558-563.
- Feng J., Grochala W., Jaron T., Hoffmann R., Bergara A., and Ashcroft N.W. (2006), Structures and potential superconductivity in SiH_4 at high pressure: En route to "metallic hydrogen", *Phys. Rev. Lett.*, **96**, 017006.
- Grzechnik A., Crichton W.A., Syassen K., Adler P., and Mezouar M. (2001), A new polymorph of ZrW_2O_8 synthesised at high pressures and temperatures, *Chemistry of Materials*, **13**, 4255-4259.
- Hanfland M., Schwarz U., Syassen K., and Takemura K. (1999), Crystal structure of the high-pressure phase silicon VI, *Phys. Rev. Lett.*, **82**, 1197-1200.
- Hanfland M., Syassen K., Christensen N.E., and Novikov D.L. (2000), New high-pressure phases of lithium, *Nature*, **408**, 174-178.
- Hanfland M. and Müller H. (2006), Structural changes in $\alpha\text{-ET}_2\text{J}_3$ at high pressure, work in progress.
- Hejny C., Lundegaard L.F., Falconi S., McMahon M.I., and Hanfland M. (2005), Incommensurate sulfur above 100 GPa, *Phys. Rev. B*, **71**, 020101.
- Keen D.A., Hull S., Barnes A.C., Berastegui P., Crichton W.A., Madden P.A., Tucker M.G., and Wilson M. (2003), Nature of the superionic transition in Ag^+ and Cu^+ halides, *Phys. Rev. B*, **68**, 014117.
- Li L., Weidner D.J., Raterron P., Chen J., and Vaughan M. (2004), Stress measurements of deforming olivine at high pressure, *Physics of Earth and Planetary Interiors*, **143-144**, 357-367.
- Loubeyre P., Le Toullec R., Häusermann D., Hanfland M., Hemley R.J., Mao H.K., and Finger L.W. (1996), X-ray diffraction and equation of state of hydrogen at megabar pressures, *Nature*, **383**, 702-704.
- Mei Q., Benmore C.J., Hart R.T., Bychkov E., Salmon P.S., Martin C.D., Michel F.M., Antao S.M., Chupas P.J., Lee P.L., Shastri S.D., Parise J.B., Leinenweber K., Amin S., and Yarger J.L. (2006), Topological changes in glassy GeSe_2 at pressures up to 9.3 GPa determined by high-energy x-ray and neutron diffraction measurements, *Physical Review B*, **74**, 014203.
- Mezouar M., Faure P., Crichton W.A., Ramber N., Sitaud B., Bauchau S., and Blattmann G. (2002), Multichannel collimator for structural investigation of liquids and amorphous materials at high pressures and temperatures, *Rev. Sci. Instr.*, **73**, 3570-3574.
- Parfitt D.C., Keen D.A., Hull S., Crichton W.A., Mezouar M., Wilson M., and Madden P.A. (2005), High-pressure forms of lithium sulphate: Structural determination

and computer simulation, *Physical Review B*, **72**, 054121.

- Perrillat J.P., Daniel I., Koga K., Reynard B., Cardon H., and Crichton W.A. (2005), Kinetics of antigorite dehydration: A real-time x-ray diffraction study, *Earth and Planetary Science Letters*, **236**, 899-913.
- Rozenberg G.K., Pasternak M.P., Xu W.M., Amiel Y., Hanfland M., Amboage M., Taylor R.D., and Jeanloz R. (2006), Origin of the Verwey transition in magnetite. *Phys. Rev. Lett.*, **96**, 045705.
- Schulze C., Lienert U., Hanfland M., Lorenzen M., and Zontone F. (1998), Microfocusing of hard x-rays with cylindrically bent crystal monochromators, *J. Synch. Rad.*, **5**, 77-81.
- Schwarz U., Takemura K., Hanfland M., and Syassen K. (1998), Crystal structure of cesium-V, *Phys. Rev. Lett.*, **81**, 2711-2714.
- Solozhenko V.L., Turkevich V.Z., Kurakevych O.O., Crichton W.A., and Mezouar M. (2002), Kinetics of diamond crystallization from the melt of the Fe-Ni-C system, *J. Phys. Chem. B*, **106**, 6634-6637.
- Wang Y.B., Durham W.B., Getting I.C., and Weidner D.J. (2003), The deformation-DIA: a new apparatus for high temperature triaxial deformation to pressures up to 15 GPa, *Rev. Sci. Instr.*, **74**, 3002-3011.
- Zhuang Y.X., Jiang J.Z., Zhou T.J., Rasmussen H., Gerward L., Mezouar M., Crichton W.A., and Inoue A. (2000), Pressure effects on Al₈₉La₆Ni₅ amorphous alloy crystallization, *App. Phys. Lett.*, **77**, 4133-4135.

MATSCI: Materials Science

Summary

ID11 was one of the first beamlines to go online at the ESRF and has been continually upgraded over the last ten years to take advantage of emerging technology and to follow trends in materials science research. In particular ID11 was the site of the first in vacuum undulator, the first high energy microfocusing station and the first fast time-resolved diffraction experiments for irreversible reactions. In spite of changing techniques, the focus of ID11's research activities remains time and space resolved materials science. The development of three dimensional X-ray diffraction (3DXRD) microscopy on ID11 led to the construction of a dedicated station, EH2, in 1997. Due to the growing interest in these techniques, it was proposed in the last beamline review (2003) that a new station be built in order to extend this effort into the nano-domain. This outstation, EH3, was opened for user operation in February 2007, becoming one of the first second generation long beamlines at the ESRF open for the user programme.

Over the coming few years, ID11 intends to develop these nanometre beam capabilities, with application to

ID11's fields of interest. Importantly, ID11 is acting as one of the pilot projects for the other future longer and nanocapable beamlines and is working on the associated technical developments, with the ESRF support groups, such as: beam focusing, vibration studies, beam stability and active feedback and sample metrology.

Scientific case

Overview

ID11's research activities cover materials science over the entire range of substances of use to man, from soft materials such as polymers (van Hooy-Corstjens *et al.*, 2001), organic materials (Barboiu *et al.*, 2005) to glasses (Yavrai *et al.*, 2005) and metals (Schmidt *et al.*, 2004). Traditionally, we have studied the structure and microstructure of these materials via either powder or single crystal X-ray diffraction techniques, often with spatial and/or temporal resolution. We strive to satisfy the paradigm that materials science is a field in which you must "bring the experiment to the sample", rather than the inverse. That means that we would like our methods to be adapted to studying samples of interest, rather than carefully prepared archetypes and, as such, our ongoing aim is to bridge the gap between these techniques in order to carry out high precision diffraction experiments on arbitrary samples, and to perform simultaneous hierarchical characterisation of length scales of interest in the samples. We briefly review below the activities of ID11 and their proposed evolution.

The extremely high flux and focusing capabilities at moderate to high energies available on ID11 makes it well suited for studies on very small single crystals. Single crystal studies fall broadly into two areas: structure solution and/or refinement of complex microcrystals, with up to 5000 refinable parameters (Barboiu *et al.*, 2005) and studies of fine structural details such as spin or oxidation state ordering (Blake *et al.*, 2001). Our current aim is to be able to perform such studies on polycrystalline samples via methods we are developing in order to extract single crystal quality data from polycrystalline samples (Vaughan *et al.*, 2005).

Whereas fast reversible reactions may be studied by stroboscopic techniques, most phenomena of interest to materials science are irreversible and require one shot techniques to be studied. Thanks to the high flux available on ID11 and to ongoing detector development, we have carried out many high time resolution studies of samples under the influence of heat, pressure, chemical potential, etc. For the highest time resolution (currently ~ 1 ms) or for poorly crystalline samples (*i.e.*, van Hooy-Corstjens *et al.*, 2001, Yavrai *et al.*, 2005) powder diffraction methods must be used. Higher precision single grain isolation

methods may be applied when slower (*i.e.*, minutes) time resolution is satisfactory (*i.e.*, Offerman *et al.*, 2002; Schmidt *et al.*, 2004).

Our interest in total hierarchical characterisation has led us to develop new methods aimed at the study of polycrystalline samples over several length scales, from the atomic scale (sub-nanometre, crystal structures) to the grain distribution over the entire sample (millimetre, see Juul Jensen *et al.*, 2006 for a recent review). The sub-micrometre range is of particular interest in materials science as it is the critical length scale for many inter-granular interactions such as dislocations and cracks, as well as being important for interfaces and surface layers. It is these interactions which ultimately give rise to the bulk properties of continuous materials. The lack of a detailed knowledge of the distributional heterogeneity of properties on this scale has resulted in our inability to construct rigorous first-principles models of basic materials properties like strength, fatigue resistance, and texture development. The weakness of present models for these processes arises from the lack of appropriate experimental data on the length scale of interest. This lack is due, in large part, to the limitations of the methods available in analysing the structure of the samples appropriate to studying such phenomena. Bulk information may be collected by powder diffraction, but such data represents an ensemble average over the sample grains, and is uninformative on sample inhomogeneity, inter-granular interactions and the form of distributions of properties. Data from electron microscopy (diffraction or imaging) is of very high spatial and angular resolution, and may be used to study inter-granular interactions and, somewhat tediously, may be used to build up grain statistics. However this technique is limited to surfaces only, and is not generally amenable to *in situ* experiments. X-ray tomography is another tool for studying sample microstructure, although the nature of the image data is different, and very complementary, to diffraction data. Our aim is thus to function as the bulk equivalent of an electron microscope, and acquire spatial and structural data in the sub-micron scale in bulk samples.

Techniques

Almost all of the work on ID11 is diffraction carried out with two dimensional detectors. The choice of the particular detector is based on the needs of the experiment under consideration. Traditionally we have used different detectors for single crystal studies (Bruker Smart system), time-resolved diffraction studies (Frelon camera), and high-resolution mapping studies (in-house developed high resolution camera). The majority of experiments at ID11 feature *in situ* or *in operando* conditions. Diverse sample environments, including furnaces, helium and nitrogen cooling systems, stress rigs and gas charging apparatuses are available.

Over the past several years we have developed an array of methods to study samples on the micrometre scale via multi-crystal diffraction. Due to the success of this programme, in the last beamline review (2003) we proposed to extend these methods into the nanoscale by developing a station devoted to studies with sub-micrometre (down to 100 nm or less) spatial resolution. This station (EH3) opened for user operation in the beginning of 2007. Furthermore, in EH3, we will implement a compound detector in order to have access to all of the different techniques simultaneously.

Over the history of ID11, the constant trend has been to perform experiments at higher energy; currently the beamline operates almost exclusively in the range 24 to 99 keV. In a very general sense, all types of crystallography are better carried out at higher energies, for a variety of reasons. In the case of single crystal diffraction, the use of higher energies removes the necessity to perform approximate corrections for sample absorption and extinction, whereas in the case of experiments using two dimensional detectors, the use of high energy allows the placement of the detector further away from the sample (due to the compaction of the diffraction cone, and the negligible effects of air scattering). By doing this, the signal to noise ratio is decreased (due to the diffraction signal being more collimated than background due to *i.e.* fluorescence, Compton scattering, etc.) the angular resolution is improved, due to the reduction of effects due to sample size, and the angular accuracy is improved, as sample offsets become less important. Other techniques used on ID11, such as grain mapping or pair-distribution function analysis, also depend critically on high energy radiation. These considerations have led to the optimisation of ID11 for high energy operation.

Context with new sources and user community

The current wave of new synchrotron sources, almost all optimised for operation in the softer X-ray region (with negligible flux above about 30 keV) has further reinforced our decision to specialise in high energy applications, as this is one area in which the ESRF will remain the world leader. Indeed, several of the new sources are expected to perform better than the ESRF in the soft and moderate (*i.e.* below 20 keV) energy regions. Only PETRA-III will offer a comparable performance in the high energy regime. We therefore do not anticipate a high impact to our user programme due to the emergence of the new sources. It is thus our conviction that we should continue our specialisation in high energy work, in particular in high energy focusing. The ESRF is in a dominant position in this area which it should strive to retain.

Many of the developments in high energy focusing have been carried out on ID11 in collaboration with colleagues from central groups.

ID11 has a rather stable interaction with a broad user community covering essentially the entire spectrum of scientific and engineering fields; experiments have been performed by scientists from biology, chemistry, chemical engineering, materials science, physics, civil and electrical engineering and even astrophysics and art history. An important part of our interaction with the user community is our successful participation in numerous European networks. This gives us access to wide networks of collaborators, many of whom were previously unfamiliar with the ESRF. Currently we are involved in networks to studying bulk metallic glasses, hydrogen storage materials, nanoscale chip technology (with partners from the microelectronics industry) and the total crystallography project described above. Through these networks, many new users, mostly thesis students and post-doctoral fellows, have been introduced to the ESRF, with some going on to become repeat users when they become established scientists.

Technical considerations

We are currently in the process of a major upgrade which will make ID11 the first of the new set of long beamlines; as such there are many technical issues to resolve in order to fully exploit the possibilities made available by this evolution. Careful consideration was taken when designing the extension in order to minimise the effects of vibrations, temperature gradients and other potential instabilities.

The criterion for our techniques to be applied is that a sufficiently small quantity of sample is present in the beam for the diffraction spots to be differentiable. As we wish to work with arbitrary samples, we would therefore like to be capable of producing beams of the smallest possible sizes. Optical developments, many of which have come from the ESRF, have demonstrated that sub-100 nm beams can be produced; the challenge now is to be able to exploit such beams, which will require beam monitoring and sample metrology to the same precision. We have thus developed our new experimental station with these technical criteria in mind. The methods we will apply will be the same array of methods which we have been developing over the last few years. It is our aim to both extend them into the nanoscale and integrate their application so that we can perform simultaneous hierarchical characterisation of polycrystalline samples, and study their crystal, microstructure and spatial distribution at the same time – that is, their structure from the angstrom to the millimetre scale.

With the present 3DXRD microscope, the spatial resolution is $\sim 5 \mu\text{m}$, while grains of 150 nm can be observed. The extension project aims to allow us to obtain sub-micron mapping resolution, with transverse resolutions below 100 nm. In order to achieve this, it will be necessary not only to obtain sub-micron beams, but for the entire experimental configuration to be characterised on that length scale. This implies, beyond the development of focusing optics, the construction of a goniometer with nanometre scale sphere of confusion, beam and sample position monitoring on the same level, improved vibration and temperature control and active feedback. The strong and ongoing development programme within the ESRF Optics Group assures that several methods to produce sub-micron beams are available, and the sample positioning requirements should be able to be met at least partially via commercially available solutions. Beam and sample position monitoring, and the integration with the feedback system, are the target of in-house development projects uniting several groups. Initial operation of the new facility took place at the beginning of 2007; the first phase optics and diffractometer were commissioned at the end of 2006.

In the initial phase, "moderate" (*i.e.* 0.5 to 2 μm) focusing optics consist of bent Laue crystals, a KB multilayer mirror system, and a compound refractive lens "transfocator", which allows for tunable focus between about 1 μm and 1 mm by insertion of lenses in the beam. The smallest focus will be achieved by nanolenses etched made with silicon wafer technology. During our initial tests we have achieved 200 nm focus at 45 keV with this device.

Over the next two years we will test diverse schemes aimed at improving sample and beam metrology and positioning to the level necessary to carry out experiments over longer times and spatial domains. We anticipate having obtained sufficient expertise in these areas to develop a new, dedicated nano-compatible diffractometer for studies in the 100 to 200 nm range.

References

- Barboiu M., Vaughan G.B.M., Graff R., and Lehn J.M. (2003), Self-assembly, structure, and dynamic interconversion of metallosupramolecular architectures generated by Pb(II) binding-induced unfolding of a helical ligand, *J. Am. Chem. Soc.*, **125**, 10257-10265.
- Blake G.R., Palstra T.T.M., Ren Y., Nugroho A.A., and Menovsky A.A. (2001), Transition between orbital orderings in YVO₃, *Phys. Rev. Lett.*, **87**, 245501-1.
- Juul Jensen D., Lauridsen E.M., Margulies L., Poulsen H.F., Schmidt S., Sorensen H.O., and Vaughan G.B.M. (2006), X-ray microscopy in four dimensions, *Materials Today*, **9**, 18-25.
- Offerman S.E., van Dijk N.H., Sietsma J., Grigull S., Lauridsen E.M., Margulies L., Poulsen H.F., Rekveldt M.T.,

and van der Zwaag S. (2002), Grain nucleation and growth during phase transformations, *Science*, **298**, 1003-1005.

- Schmidt S., Nielsen S.F., Gundlach C., Margulies L., Huang X., and Jensen D.J. (2004), Watching the growth of bulk grains during recrystallization of deformed metals, *Science*, **305**, 229-232.
- van Hooy-Corstjens C.S.J., Höhne G.W.H., and Rastogi S. (2005), Inverse melting in syndiotactic polystyrene, *Macromolecules*, **38**, 1814-1821.
- Vaughan G.B.M., Schmidt S., and Poulsen H.F. (2004), Multicrystal approach to crystal structure solution and refinement, *Z. Krist.*, **219**, 813-825.
- Yavari A.R., Le Moulec A., Inoue A., Nishiyama N., Lupu N., Matsubara E., Botta W.J., Vaughan G.B.M., Di Michiel M., and Kvik Å. (2005), Excess free volume in metallic glasses measured by X-ray diffraction, *Acta Materialia*, **53**, 1611-1619.

POW: High Resolution Powder Diffraction

Summary

The ESRF high resolution powder diffraction beamline provides highly accurate data for the structural investigation and analysis of powders, thin layers, polycrystalline and amorphous materials over the energy range of 6 to 60 keV and with a wide range of sample conditions, *e.g.* temperature from 3 K to 1600°C. An important attribute of the beamline is its capability to measure data with very high angular resolution at hard X-ray energies, reducing the impact of sample absorption, and allowing the acquisition of data to high values of Q . This is advantageous for practically all crystalline substances, especially absorbing metallic and inorganic systems, and also for the analysis of poorly crystalline materials via the atomic pair distribution function (PDF), a technique of growing importance. PDF analysis can be used to characterise the structures of materials that are far from ideal with regard to standard diffraction techniques, many of which are of practical as well as scientific relevance.

With the evolution of the beamline, we propose

- To take advantage of the accelerator and source Upgrade Programme to provide higher flux at hard X-ray energies and over an increased range of energies, up to 90 keV;
- To add new detectors to improve peak shapes and count rates, to improve angular resolution, and allow faster processes to be investigated;
- To upgrade the diffractometer to enable larger samples and more complex sample environments to be mounted, as well as the heavier detector systems.

Scientific case

Overview

Understanding the properties of materials requires knowledge of their structure, which is normally obtained via single crystal diffraction measurements. However, many materials of interest do not form suitable single crystals. Crystals may be impossible or very difficult to grow, or may fracture or split into complex domains in passing through a phase transition. Powder diffraction must then be used instead. Typical systems that are studied as powders include complex oxide materials with superconducting, magnetic or electronic properties, microporous materials and metal-organic-framework compounds, alloys and hydrides for potential storage of hydrogen, and polymorphs and salts of pharmaceutical compounds chosen for their physical properties such as shelf life and dissolution rate rather than their tendency to form convenient single crystals. Even proteins have recently been shown to be accessible by powder methods. For structural analysis of such materials, accurate, high resolution data is imperative, for the narrow peak width reduces the degree of overlap between neighbouring reflections and thereby maximises the information content of the complex powder diffraction profile.

Powder diffraction methods can also be used to characterise structures lacking the strict translational periodicity of crystalline materials, such as glasses, quasicrystals, nanoparticles, nanocrystals, aperiodic, disordered and partially disordered systems, etc. The atomic pair distribution function, $G(r)$, calculated from data extending to high values of scattering vector, gives information about the characteristic distances between pairs of atoms within the structure. A theoretical $G(r)$ can also be calculated from a model atomic arrangement, such as a postulated structure for a nanoparticle, and compared with the experimental values. By minimising the differences between the two, the model can be refined in a manner analogous to Rietveld refinement for crystalline structures. Furthermore, a procedure now exists that allows the structure of a nanoparticle to be solved *ab initio* via the atomic PDF without the use of prior structural information.

Powder diffraction is also used for a wide range of other applications. The structural evolution of systems can be studied *in situ*, as a function of temperature, time, atmosphere, voltage, etc. to explore phase changes, solid state chemistry, electrochemistry, etc. Indeed, the relative ease of performing powder measurements means that powders are normally the preferred approach, and powdered samples usually correspond more closely to the ingredients of real materials and processes. If screening a large number of samples formed under different conditions or

synthesised with different compositions, then working with powdered specimens is the most efficient approach. A traditional role for powder diffraction is in phase analysis, identifying and quantifying the different materials making up a composite sample. With high resolution data, complex mixtures can be examined, and the better the statistical quality of the diffraction pattern, the greater the sensitivity towards trace phases, which sometimes are revealed to be critical components in a system.

Powder diffraction is also used to investigate the microstructure of materials, (*e.g.* particle size distribution, stacking faults, microstrain), from analysis of the peak shapes. With high resolution measurements, the instrumental contribution to the observed peak shape is minor, allowing greater sensitivity to the microstructural characteristics of the sample. With high X-ray flux and appropriate detectors, the evolution of microstructure can be followed during materials processing, such as during rapid grain growth on annealing nanocrystalline metals at elevated temperatures. Measurements of residual bulk strain in components can also be mapped by powder diffraction, measuring the position of a Bragg peak from a treated surface or in a weld as a function of sample position or orientation. By selecting the X-ray energy, the depth of penetration into the sample can be controlled, soft energy for surface selectivity, hard energy to penetrate through. Finally, powder diffraction equipment lends itself conveniently to the study of surfaces and surface layers via grazing incidence diffraction and reflectivity.

Techniques

The excellent resolution of the ID31 beamline is achieved via the high vertical collimation of the incident beam combined with the stringent angular acceptance of the detector system. The latter consists of a bank of nine Si(111) analyser crystals, each channel separated from the next by $\sim 2^\circ$. When scanning the detector arm, nine high resolution diffraction patterns are collected simultaneously and are combined in a data reduction step. The analyser crystals define the 2θ angle of the photons transmitted to the detectors and are so selective (a few μrad acceptance depending on energy) that only a tiny proportion of diffracted photons ever pass. It is for this reason that nine channels are needed, to improve and make practicable the overall efficiency of the system. High incident flux is therefore also required, and is best provided by a horizontally collimated source such as an undulator. A bending magnet or wiggler are poorly suited, as the radiation emitted in a fan must be focused by a toroidal mirror or by sagittal bending of a crystal back onto the sample. Both these approaches degrade the vertical collimation of the synchrotron beam and are incompatible with a powder diffraction instrument aiming for the highest angular resolution.

ID31 has three 11 mm gap undulators, covering the entire range of 6 to 60 keV, which is required to carry out the broad scientific programme outlined above, and to allow anomalous scattering measurements for any element above titanium in the periodic table. With the hard energies available, high resolution data can be readily obtained in transmission from samples contained in spinning glass capillaries without problems of absorption. Capillaries lead to higher accuracy in the diffracted peak intensities because they minimise preferred orientation effects commonly suffered by flat plate specimens. The analyser crystals impose very high angular resolution and, moreover, high accuracy in the peak positions, immune from aberrations that affect scanning-slit systems and position sensitive detectors, such as caused by misalignment of the sample, specimen transparency, surface effects, etc. This is because an analyser crystal defines a true angle of acceptance rather than infers that angle from the position of a slit or a pixel on a PSD. Accurate peak positions are essential to recreate the three dimensional crystal lattice from a one dimensional powder diffraction pattern and for accurate measurements of residual strain where surface effects perturb conventional instruments.

Measurements can be made under a wide range of conditions, *e.g.* temperatures from 3 K to 1600°C, (a range soon to be extended with a new laser heating system), under laser excitation, and a gas cell is available for experiments such as *in situ* hydrogen adsorption. The beamline has a sample changing robot, allowing fifty samples to be screened automatically, compatible with the temperature range of 80 K to about 1300 K. The latter has been employed to investigate systematically, with very high angular resolution, phase diagrams, proteins precipitated under different conditions of pH or salt concentration, or to study *in situ* series of solid solutions of hydrides with potential use as hydrogen storage materials undergoing hydrogen release on heating.

Context with new sources and user community

The interest in powder diffraction stems from the intrinsic properties of the diverse samples under investigation. By exploiting a synchrotron, the highest quality data can be collected and thus the most complex problems investigated. Thus most European synchrotron radiation sources have a powder diffraction capability, with established user communities to match, though none attains the power of ID31 with regard to flux, nor resolution. Thus many of the most demanding applications have been carried out at the ESRF. The new national synchrotrons under construction generally include a powder diffraction beamline based on an insertion device to deliver the maximum flux to the

sample. Owing to the operating energy of these new sources, 3 GeV or below, the powder beamlines will function at photon energies up to around 30 keV, where the flux is markedly declining. Whilst these new facilities will provide a degree of overlap with ESRF capabilities at lower energies, the ESRF will remain dominant above 20 keV, where the majority of ID31 experiments are already performed. The new sources will therefore provide a much improved capability to their already vibrant national programmes, but will probably make relatively modest impact on the high energy operation at the ESRF. Measurements at lower energies carried out at a national source instead of the ESRF are likely to be more than offset by the increased interest in measuring atomic PDFs, where high flux at hard energies is a necessity and where the ESRF is capable of providing a major resource. Furthermore, the number of samples containing absorbing elements that require accurate measurement by high resolution powder diffraction is essentially limitless. Note that with its degree of over subscription, ID31 operates in all storage ring modes, including the lower flux timing modes, where high quality powder diffraction patterns can still be measured, albeit on a slower timescale.

Technical considerations

High resolution powder diffraction is not a technique that requires a microfocused beam. Indeed, to have a good statistical powder average, a fair volume of sample needs to be illuminated, and a beam size of 1 to 2 mm horizontal by 0.5 to 1.5 mm vertical is usual on ID31, although smaller samples can easily be measured as necessary. ID31 was built on a low- β sector of the storage ring because this was the only unoccupied straight section available at the time, and the one to two orders of magnitude increase in incident flux as compared to BM16 was already a huge improvement. Ideally, with a relatively large beam size on the sample and to give an enhanced flux and improved resolution from having a lower horizontal divergence, a high- β sector would be preferable. Thus, if the beamline needs to be moved from ID31, to release a long beamline position in the extended Experimental Hall, relocation should be to a high- β sector.

Future developments. Over the coming years, the beamline should evolve as the machine and detector capabilities allow, especially operating with X-ray energies up to 90 keV and therefore allowing penetration through steel. More complex sample environments will be possible, such as a cell for high resolution studies under pressures up to a few GPa. Improved detectors will enhance even further the angular resolution and promote measurements of faster dynamic processes.

1) The upgrade of the source to in-vacuum undulators

With the extension of the straight sections in the

machine to 7 m, it will be possible to replace two of the 11 mm gap ex-vacuum undulators with in vacuum devices. This will increase the X-ray flux in the hard energy regime and thereby, for example, enhance anomalous scattering measurements at the K edges of the rare earth elements (particularly for glasses), and improve throughput when working with absorbing sample environments or mapping residual strain in large components. An extension of the energy range up to 90 keV is highly desirable, allowing penetration through greater thicknesses of metals such as steel, nickel and the superalloys used in aircraft jet engines. Strain mapping is currently limited to about 1 mm thickness of such materials, though several cm of titanium or aluminium alloys can currently be measured at 60 keV. The use of the analyser crystals with strain mapping provides data of very high accuracy, free from surface aberrations, and is therefore complementary to the possibilities available on ID11 and ID15. Thus such an upgrade is particularly relevant for materials science applications and *in situ* measurements, and reinforces the position of the ESRF as a facility for hard energy operation.

2) Developments in detectors will yield considerable benefits. For example, diffraction peak shapes and count rates can be further enhanced by replacing the actual zero-dimensional counters behind the analyser crystals with one dimensional detectors that can resolve the axial position of the incoming photon. The location of the detected photon around the Debye-Scherrer cone can then be obtained, allowing a more accurate 2θ angle to be calculated. Such an approach would eradicate low angle asymmetry in the peak shapes, thereby enhancing the intrinsic angular resolution further and simplifying the instrumental peak shape function for enhanced microstructural characterisation. Furthermore, the increased solid angle from increasing the axial dimensions of the detectors will lead to an order of magnitude improvement in overall detector efficiency.

A position sensitive detector is required to complement the high resolution data obtained from scanning the analyser crystals (a relatively slow procedure with a maximum time resolution of the order 10 s). A curved, one dimensional detector would provide data at a much faster rate, allowing rapid processes to be investigated, albeit at lower angular resolution. A curved detector can also be used to improve the efficiency of collecting data for samples prone to radiation damage, or at high angle for poorly crystalline materials (*e.g.* for PDF analysis), where peak broadening from the sample reduces the need for the highest instrumental resolution, but counting statistics become of crucial significance. Note that a PSD has a higher background as it is more open, and is less able to discriminate against Compton scattering, but nevertheless can yield important complementary information, *e.g.* for

studying the evolution of a glass or nanocrystalline system during heat treatment. A two dimensional detector such as a flat panel or CCD camera could be an alternative. Although the data extend less far in 2θ , the large solid angle and the ability to characterise texture or graininess in the sample from intensity variations around the Debye-Scherrer rings can be extremely useful. To optimise resolution, a PSD would be combined with focusing of the beam onto the detector using refractive optics, also useful for improved spatial resolution when strain mapping with the analyser crystals, where beams of the order $0.1 \times 0.5 \text{ mm}^2$ are typically used.

3) Diffractometer upgrade

The high resolution powder diffractometer on BM16/ID31 has performed extraordinarily well over the ten years that the beamline has been in operation. However, for mounting bulky samples and sample environments the distance from the diffractometer to the beam position is restrictive and places limitations on what can be mounted in the beam. A larger, stronger, though equally accurate diffractometer would be necessary to mount the enhanced detector capabilities referred to above and for complex sample environments. Such a diffractometer is available commercially. Furthermore, to study strain in the largest of engineering components, such as aircraft parts etc. made possible with the upgrade to 90 keV, a dedicated vertical-axis diffractometer will be required, independent from the high resolution powder diffractometer for powder crystallography.

References

- Chater P.A., David W.I.F., Johnson S.R., Edwards P.P., and Anderson P.A. (2006), Synthesis and crystal structure of $\text{Li}_4\text{BH}_4(\text{NH}_2)_3$, *Chem. Commun.*, 2439-2441.
- Fitch A.N. (2004), The high resolution powder diffraction beam line at ESRF, *J. Res. Natl. Inst. Stand. Technol.*, **109**, 133-142.
- Gramm F., Baerlocher C., McCusker L.B., Warrender S.J., Wright P.A., Han B., Hong S.B., Liu Z., Ohsuna T., and Terasaki O. (2006), Complex zeolite structure solved by combining powder diffraction and electron microscopy, *Nature*, **444**, 79-81.
- James M.N., Hughes D.J., Chen Z., Lombard H., Hattingh D.G., Asquith D., Yates J.R., and Webster, P.J. (2007), Residual stresses and fatigue performance, *Engineering Failure Analysis*, **14**, 384-395.
- Kanatzidis M. and Billinge S.J. (2004), Beyond crystallography: the study of disorder, nanocrystallinity and crystallographically challenged materials with pair distribution functions, *Chem. Commun.* p. 749-760.
- Margadonna S., Prassides K., Fitch A.N., Salvador J.R., and Kanatzidis M.G. (2004), Valence instabilities, phase transitions, and abrupt lattice expansion at 5 K in the YbGaGe system, *J. Am. Chem. Soc.*, **126**, 4498-4499.
- Sage M.H., Blake G.R., Nieuwenhuys G.J., and Palstra T.T.M. (2006), Evidence for electronic phase separation between orbital orderings in SmVO_3 , *Phys. Rev. Lett.*, **96**, 036401.

TRD: Time-Resolved Diffraction and Pump-and-Probe

Summary

We propose to build a dedicated beamline for pump-and-probe and time-resolved diffraction covering the timescale from 10 picoseconds to seconds in studies of physical, chemical and biological processes. The beamline will have options for:

- Laue diffraction and classical diffraction;
- Solution phase SAXS and WAXS;
- Gas phase diffraction.

The realisation will require key upgrades in beamline technology: a cryogenic in-vacuum undulator for hard X-rays (30 to 60 keV), focusing multilayer optics at 60 keV, a larger high speed chopper for 3 kHz operation, a picosecond laser system and a fast CCD detector. These upgrades are expected to speed up the data acquisition time by a factor of four to eight and greatly improve the determination of excited state structures.

Scientific Case

Scientists have long dreamed of being able to film molecules undergoing chemical or biochemical reactions. This dream was first put into practice in Laue experiments on ID09B where films of simple proteins were taken to 100 ps time resolution. From these films a detailed understanding was gained of the structure-function relationships in haem proteins. In pump-and-probe experiments, short laser pulses excite a subset of molecules in the protein and delayed X-ray pulses probe the evolving structure at a given delay. When the results are stitched together, atomic motions can be visualised in real time. When the sample is not crystalline, the X-ray scattering is diffuse and atomic level information is reduced to one dimensional radial formation. Nevertheless, the intensity distribution is very sensitive to the size and shape of molecules and that can be used to discriminate between different models. This field is very important for protein dynamics in vivo where the protein is free to undergo large amplitude conformational changes.

Pump-and-probe experiments are non-routine and require substantial beamtime to optimise the experimental parameters. In the past, these efforts were often compromised when too many experiments were scheduled in too few a shifts. The modes of operation for single-bunch pump-and-probe experiments include the 4-bunch, 16-bunch and hybrid modes, which were hitherto limited to 30% of the total beam time. The new 7/8+1 hybrid mode

should expand the amount of beamtime for fast experiments to 80%. Hence we propose to dedicate ID09 to time-resolved experiments and use the remaining 20% for slower kinetics and commissioning tasks. The benefits to the user community would be enormous and more challenging experiments could be given more beamtime, which is essential for the promotion of new research areas. Finally the experience gained from ESRF pump-and-probe experiments will provide efficient technology transfer to future XFEL beamlines.

Techniques

We will now present our upgrade proposal for time-resolved crystallography, solution-phase SAXS and WAXS and gas-phase diffraction. The first three fields are already fairly well established on ID09B.

Time-resolved crystallography

The structural dynamics of small proteins such as myoglobin and haemoglobin, the yellow protein, the green fluorescence protein and bacteriorhodopsin have been studied over the last twelve years, and it has become possible to measure correlated structural changes, not only near active sites but also towards the edge of the unit cell where the changes are much weaker (Schotte *et al.*, 2003). We would like to extend these studies to larger and more complex molecules such as the photosynthetic reaction centre (RC), in which absorption of a photon generates a proton gradient across a membrane that eventually powers chemical reactions in the cell. Should this venture prove successful, the structural dynamics of light harvesting would be determined at high spatial and temporal resolution. A detailed understanding of light harvesting in plants could lead to the design of more efficient solar cells in the future.

Another important area is ultra-fast phase transitions in bulk materials induced by light. Experiments on the organic compound TTF-CA (Collet *et al.*, 2003) has shown how electron transfer in one unit cell can initiate a phase transition in macro domains on the picosecond timescale. We would like to extend this work to advanced materials with potential applications in data storage and communication technology.

Larger and faster CCD detectors will have a huge impact on the data quality and real time data reduction will critically improve the information that can be extracted from the data on the fly. We are already working on real time reduction of Laue data with automatic indexing, integration, scaling and difference map generation.

Time-resolved scattering

Proteins in solution (SAXS)

A recent study of the relaxed (R) to tense (T)

transition in haemoglobin HbCO by SAXS has demonstrated the SAXS/WAXS feasibility with concentrations down to 1mM. The measured change, $\delta S(Q, \tau)$, shows that CO dissociation drives a large change in quaternary structure, the R to T transition, which involves turning the α_2 and β_2 subunits by 25°. The refinement of the structural intermediates, the ultimate goal, will benefit from upgrades including a channel-cut ML monochromator for intense, narrow band X-rays at 8 keV, additional slits to reduce the background and a sample chamber that can be kept either under vacuum or purged with helium to minimise background scattering. Note that protein folding might be activated by fast temperature jumps induced in the solvent by an IR laser pulse.

Structural dynamics of molecules in solution (WAXS)

This field started with studies of the dissociation and recombination dynamics of model molecules such as I_2 , Br_2 , HgI_2 , $HgBr_2$ and $C_2H_4I_2$ in solution (Plech *et al.*, 2004; Ihee *et al.*, 2005; Kim *et al.*, 2006). The diffraction patterns revealed not only the structure of the photoproducts; they also revealed the cage diameters and hydrodynamic properties of the solvent. We have developed computational methods to extract the change in density, pressure and temperature as a function of time. Solution phase diffraction experiments are confronted with a general problem: how do we separate excited solute signals from the (thermally) excited solvent? By tuning the laser to the infrared, vibrational modes in solvent can be excited non-destructively, giving us the scattering signature from an ultra fast temperature jump. When this curve is subtracted from the total signal, solute plus solvent, after suitable scaling, we can deduce the solute plus cage signals without interference from heating. The future trend will be to study small biological photo systems with lower solvent contrast. The signal-to-noise ratio will improve by exciting the system with picosecond pulses and we aim to sharpen the signals using multi-layer optics instead of the pink undulator beam.

Gas phase reactions

Structural reaction dynamics in gas phase photochemistry have only been studied by ultra-fast electron diffraction, and many surprising results have been obtained including the unexpected ring opening of pyridine and the non-equilibrium structure of hexatriene produced by photo-cleavage of cyclohexadiene. The extreme flux of the pink beams on ID09B offers new possibilities for probing gas phase reactions over a wider Q range and with better spatial resolution than electron diffraction, albeit at lower time resolution. Calculations show the feasibility of X-ray diffraction at pressures between 1 to 10 torr with exposure times of 100 seconds per CCD image. Because these experiments would be performed under low pressure conditions, the S/N ratio will be superior

to liquids. It might prove feasible to increase the time resolution to 10 ps by slicing the X-ray pulse with the much shorter laser pulse, *i.e.* let the 1 to 2 ps laser pulse walk through the X-ray pulse in steps of 10 ps. With the excited state probed with a 60 ps X-ray pulse from the 7/8 hybrid mode, the time resolution for this laser slicing scheme is well below 60 ps and simulations indicate that 10 ps resolution is feasible in gas-phase experiments.

Context with new sources and user community

The majority of ESRF pump-and-probe diffraction experiments are and will be performed between 15 to 40 keV where ESRF beam, for equivalent undulator technology and bunch charges, is 25 to 250 times more intense than at 2 to 3 GeV machines. Lower energy synchrotrons in Europe (such as SLS, DIAMOND, SOLEIL and ALBA) operate or will operate in the 2.4 to 3.0 GeV range and we must make sure that an ESRF time-resolved beamline truly exploits the higher energy X-rays from the 6 GeV electrons. In addition, the large ESRF circumference (844 m) makes it easier to accept a small (chopper) hole in the bunch structure than in smaller rings. PETRA-III could, in principle, rival the ESRF but no decision has yet been made to build a pump-and-probe station.

How does a future ID09B relate to the European XFEL? The pulse length is 10 to 120 ps at the ESRF and 100 fs at the XFEL and the intensities levels are 1×10^{10} and 1×10^{12} photons per pulse respectively. The unprecedented XFEL intensity and ultra-short pulses are expected to resolve the primary steps in molecular dynamics, the breakage and formation of bonds, coherent vibrations, etc. However the XFEL pulse will destroy the sample, which will have to be renewed for every single pulse. As it is going to require supersonic speeds to exchange the sample between two adjacent XFEL pulses in a macro bunch train, the next practically usable pulse will arrive 100 ms later, making the usable flux per second identical to that of ID09B. We therefore anticipate that XFEL pump-and-probe experiments will concentrate on single shots in the time window 100 fs to 100 ps and that (stroboscopic) storage rings will be used for all slower time kinetics, covering the range 10 ps to seconds. In addition, the beam position stability and pulse to pulse reproducibility will remain a strong advantage for storage rings.

ID09B has presently 50% access to beam due to time sharing with high pressure on ID09A. That gives users 200 shifts per year distributed over 20 experiments. The general feeling is that ten shifts per experiment is insufficient for fine tuning the parameters making it difficult for young researchers to make a career in

pump-and-probe experiments. As a result the French group in Rennes, the Danish group in Copenhagen and the Korean group in Daejeon are beginning to use the Photon Factory in Japan.

Technical considerations

A pump-and-probe beamline needs a very intense X-ray beam to minimise the number of laser and X-ray pulses needed to produce a high quality CCD image of the scattered radiation. It is of great importance to have two in-vacuum undulators, one for very high flux in a narrow energy range 15 to 20 keV and a second tuneable undulator for the 8 to 60 keV range. The key source parameters for pump-and-probe experiments are the bunch charge, the undulator magnet technology, the period, the length and the minimum gap. The undulators have to be in a low- β section to obtain a small focal spot.

The brightest sources at the ESRF are in-vacuum undulators that cover the energy range 8 to 40 keV with only three harmonics. The U17 undulator is a special mono-harmonic undulator with a very high spectral flux. Its spectrum is quasi-monochromatic at 15 keV and it can produce up to 10^{10} photons in one pulse in 4-bunch mode. The bandwidth of the first harmonic is 3%, which is very good for Laue diffraction and liquids. The second in-vacuum undulator, the U20, is tuneable between 8 to 40 keV. In the future we would like to use cryo-magnets to widen the tunability up to 60 keV and extend the undulator length to make full use of the longer straight sections now available with the new lattice. Finally the bunch charge should be kept constant in the 7/8 + 1 hybrid mode by frequent top ups of the current in the storage ring.

The heat load on the optics from two in-vacuum undulators in tandem at 300 mA is 600 to 800 W which would normally present a serious engineering problem. However the newly installed heat load chopper on ID09B will reduce the load by a factor of twenty, whilst maintaining the peak brightness of the pulses selected in the pump-and-probe experiment.

The new beamline should have two monochromators. An updated channel cut monochromator using the Si(111) and Si(220) reflections to cover the energy ranges 8 to 20 keV and 20 to 40 keV. A second vessel should house a monochromator with multilayer crystals, providing three bandwidths (0.1, 1 and 3%) to cater for different Q-resolutions. The natural dispersion in a liquid is compatible with a 3% bandwidth whilst the diffraction spots from proteins begin to broaden above 0.1%.

A toroidal mirror will focus the X-ray beam with a lower demagnification M than presently used, 0.45

instead of 0.70. Ray tracing shows that spherical aberrations are small for $M = 0.45$ and that a round focus of $50\ \mu\text{m}$ as compared with $110\ \mu\text{m} \times 60\ \mu\text{m}$ (horizontal by vertical) today can be achieved. The shorter distance between the mirror and the focus will also improve the stability. We also propose to make a very intense focused beam at 60 keV with focusing multilayer optics. A cylindrical multilayer crystal will focus horizontally and a bent multilayer crystal will focus vertically. By matching the number of multilayer periods to the 1.5% bandwidth of the fifth harmonic of the 20 mm period undulator, 2×10^{10} ph/s in a $50\ \mu\text{m}$ spot at 1 kHz should be obtainable, expanding Q_{max} in scattering experiments from $9\ \text{\AA}^{-1}$ today to $27\ \text{\AA}^{-1}$. The low X-ray absorption at 60 keV will also make it possible to study ultra-fast phase transitions in bulk materials, such as laser induced infrared melting of ice.

Another key issue is the high speed chopper which isolates single pulses of X-rays from the timing modes. In 16-bunch mode the chopper only extracts 1:5760 pulses when it rotates at 1 kHz. A new prototype rotor has shown the feasibility of pulse selection at 3 kHz using a new concept, tunnel-less chopping, which will reduce the data acquisition time by three. Note that the new National Institutes of Health femtosecond laser can run at 3 kHz without losing energy per pulse. However 3 kHz chopping in the 16-bunch mode is at the limit of being possible so the rotor radius should be increased from 100 to 150 mm to produce a cleaner pulsed beam without jitter from neighbouring satellite pulses.

The detector system should be upgraded with a fast readout Frelon CCD based camera. With readout times around 0.1 s for a 15 bit 2048×2048 image, it will be possible to collect up to 100 spectra $\Delta S(Q, t)$ from a liquid per hour as compared with 25 today.

An extensive laser facility is another key feature. Spectra Physics and Coherent have launched a new generation of tuneable picosecond lasers, which are better matched to the X-ray pulse length from a synchrotron. The lower peak electric fields in picosecond pulses are more gentle to the sample, which will improve the achievable excitation level and the sample lifetime. The laser should have an optical parametric amplifier to shift the wavelength from the UV to the IR at power level between 0.5 to 5 W.

Sample positioning is very important in crystallography and we propose to install a four-circle diffractometer for a more complete sampling of k -space. Finally the beamline should have a 2 to 4 m long detector arm for SAXS to reach a Q_{min} of $0.01\ \text{\AA}^{-1}$ in protein dynamics.

Support facilities

There is a great need for a chemistry and sample mounting laboratory near the beamline and a workshop with test benches for laser and X-ray optics. A small laser laboratory with an absorption spectrometer would be very useful. Finally, beamline staff should have offices near the beamline.

References

- Collet E., Lemée-Cailleau M.H., Buron-Le Cointe M., Cailleau H., Wulff M., Luty T., Koshihara S.Y., Meyer M., Toupet L., Rabiller P., and Techert S. (2003), Laser-Induced Ferroelectric Structural Order in an Organic Charge-Transfer Crystal, *Science*, **300**, 612-615.
- Ihee H M., Lorenc M., Kim T.K., Kong Q.Y., Cammarata M., Lee J.H., Bratos S., and Wulff M. (2005), Ultrafast X-ray Diffraction of Transient Molecular Structures in Solution, *Science*, **309**, 1223-1227.
- Kim T., Lorenc M., Lee J.H., Lo Russo M., Kim J., Cammarata M., Kong Q., Noel S., Plech A., Wulff M., and Ihee H. (2006), Spatiotemporal reaction kinetics of an ultrafast photoreaction pathway visualized by time-resolved liquid x-ray diffraction, *Proc. Natl. Acad. Sci. USA*, **103**, 9410-9415.
- Plech A., Wulff M., Bratos S., Mirloup F., Vuilleumier R., Schotte F., and Anfinrud P.A. (2004), Visualizing Chemical Reactions in Solution by Picosecond X-Ray Diffraction, *Phys. Rev. Lett.*, **92**, 125505-1.
- Schotte F., Lim M., Jackson T.A., Smirnov A.V., Soman J., Olson J.S., Phillips G.N., Wulff M., and Anfinrud P.A.. (2003), Watching a Protein as it Functions with 150-ps Time-Resolved X-ray Crystallography, *Science*, **300**, 1944-1947.

Introduction to the Conceptual Design Reports of the Soft Condensed Matter Group

Introduction: The five conceptual design reports of the Soft Condensed Matter Group summarise ideas on the future of soft condensed matter, both at the ESRF and also in a European environment. Whilst all beamlines of the Soft Condensed Matter Group have constantly evolved and been adapted to user requirements, the proposed upgrade projects represent a major development step. The general aim is to maintain and improve the unique capabilities in SAXS/WAXS, surface scattering and microbeam scattering to XPCS. Meanwhile, challenging new developments are proposed for USAXS, CDI, and nanobeam scattering.

Novel beamline features: Extra long canted undulator sections generate a new freedom in beamline design by providing space for new instrumental developments. This allows the beam properties to be optimised for the individual branches. Thus the splitting of the Troika beamlines ID10A/C,B into separate branches will permit optimisation of beam coherence for XPCS and CDI (XPCS-CXS). Surface and interface studies will profit from shorter wavelength and enhanced focusing capabilities (GISD). ID02 proposes a pinhole USAXS camera, which will open the field of time-resolved USAXS experiments (SAXS). The complimentary

Summary of individual CDRs

| | | |
|-----------------|--|---------|
| GISD | Grazing Incidence Scattering and Diffraction: This CDR proposes transferring the Troika ID10B branch to a new canted undulator branch in order to optimise grazing incidence techniques. The new location will (i) allow the flux and beam quality (small size and low divergence) to be increased; (ii) enable new non-scanning techniques that will shorten regular experiments, allowing time resolved measurements with reduced radiation damage; (iii) improve studies at buried liquid interfaces; (iv) provide more floor space. | page 50 |
| HISAXS | High Throughput Small Angle X-ray Scattering: A new bending magnet beamline is proposed with an emphasis on high throughput SAXS/WAXS solution scattering on topics ranging from proteins, soft condensed matter to materials science and chemistry. The beamline should provide turn key-style operation including mail-in data collection service and online data analysis capabilities. An important aspect would be to foster on-site and partnership collaborations as well as provide test beamtime in the context of long term projects or grant applications. | page 54 |
| MINADIF | Micro- and Nano-Diffraction: The proposal aims to provide two independently operating branches for micrometre and nanometre sized beams for SAXS/WAXS, as well as complimentary techniques such as μ Raman, μ X-ray fluorescence (μ XRF). With the proposed project new research opportunities spanning the range from micrometre to nanometres sized beams will be established. This will benefit a wide user community, in particular soft condensed matter (SCM), functional and structural biology (MX) in particular. | page 55 |
| SAXS | Small Angle X-ray Scattering: The proposed project aims to enhance SAXS/WAXS and USAXS performance. Non-traditional scattering and imaging methods such as near-field X-ray scattering will also be developed. The emphasis will be on quantitative scattering experiments, complex sample environments and advanced data analysis methods. | page 60 |
| XPCS-CXS | X-ray Photon Correlation Spectroscopy and Coherent X-ray Scattering: It is proposed to transfer the Troika ID10A/C branches to a new canted undulator branch. This will allow the coherent beam properties for X-ray photon correlation spectroscopy (XPCS), coherent SAXS and CDI. The beamline will host two experimental stations and associated laboratories. | page 63 |

NFXS technique will extend the lower Q-range by an order of magnitude. ID13 proposes to split nanobeam and microbeam R&D into two dedicated branches, thus providing the possibility of a better adaptation to specific user requirements (MINADIF). The HISAXS bending magnet project proposes high throughput capabilities with an emphasis on microfluidic experiments. The ESRF could benefit from this fast growing area due to the number of potential user groups, in particular those having a biological orientation.

Challenges in instrumentation and sample environments: The proposed beamline upgrades will require new developments in optics, detectors and sample environments. Particular challenges are the development and integration of nanofocusing optics into a beamline environment. This also applies to sample observation and manipulation tools (*e.g.* AFM). Fast framing pixel detectors will allow a breakthrough in XPCS but the development of "workhorse" CCDs should not be abandoned. Microfluidics promises fascinating scientific applications. However, this will require a technological base at the ESRF in order to develop custom-made cells.

Annexe facilities: the establishment of a "cluster" of SCM beamlines including shared laboratories and offices will make it possible to enhance collaborations between the beamlines themselves and also with external partners. The aim should be the development of science-driven partnerships with an emphasis on scientific excellence. Soft condensed matter specific data analysis and modelling capabilities should be incorporated. This could develop into a unique European platform for synchrotron based Research and Development in soft condensed matter.

GISD: Grazing Incidence Scattering and Diffraction

Summary

Grazing incidence surface X-ray scattering provides direct access to the structure of artificially and self ordered two dimensional inorganic, organic, biological and composite systems with characteristic length scales from a few tenths of a nanometre to several micrometres. The interest in grazing incidence X-ray scattering has been constantly increasing since the first demonstration of its efficiency in structural characterisation of films along the surface normal (reflectivity in 1950s) and in the film plane (grazing incidence diffraction in 1980s). Today the technique finds wide applications in characterisation of various nano- (self-assembling monolayers of molecules and macromolecules at the air-water interface), meso- (colloids and micelles at the interface) and micro- (thin films of polymer blends or block copolymers) structured surfaces. The studies of organic materials require a high X-ray flux because of the weak scattering. For example, the typical GIWAXS signal measured on Langmuir layers at aqueous surfaces is between 10^{-10} to 10^{-11} of the incident beam. Therefore synchrotron radiation sources play a very important role in the advancement of this field.

The Troika II (ID10B) beamline uses a semi-transparent diamond monochromator as a beam splitter, making it a quasi-independent unit of the multi-purpose, high brilliance open undulator Troika beamlines ID10. The Troika II beamline carries out a large variety of grazing incidence scattering experiments on hard condensed matter. Special emphasis, however, lies in the study of soft condensed matter. ID10B provides different types of scattering techniques and many sample environments for studies on gas/liquid interfaces. Recent upgrades of the beamline optics allow higher energies ($E_{\max} = 22$ keV) to be used and enable the investigations of buried liquid/solid and liquid/liquid interfaces (Konovalov *et al.*, 2005), a domain which, so far, has been largely unexplored.

We propose further development of the Troika concept by splitting the beam with canted undulators and building two independent beamlines moving from ID10 to ID28 (for example), which has the necessary space to accommodate a long and wide assembly of three stations. The proposed measures will: 1) increase the flux and beam quality (small size and low divergence); 2) enable new non-scanning techniques that will shorten regular experiments, allowing time-resolved measurements with reduced radiation damage; 3) considerably improve studies at buried liquid interfaces.

Scientific case

Overview

Soft condensed matter science involves studies in many branches of modern physics, biology, chemistry and material science and covers a large range of length scales from nanometre to several microns. Whereas many techniques characterise the bulk properties of soft condensed matter, the surface sensitive methods give access to the organisation and phenomena at interfaces where low dimensionality and surface energy either alter the bulk properties or bring a new character. ID10B carries out research in various directions and here we highlight only some of them.

Physics of interface between two media on short length scales. Liquid-vapour interfaces were first described as regions of continuous variation of density, caused by density fluctuations within the bulk phases. In contrast, the more recent capillary-wave model assumes a step-like local density profile across the liquid vapour interface, whose width is the result of the propagation of thermally excited capillary waves. The model has been validated for length scales of tenths of micrometres and larger, but the structure of liquid surfaces on sub-micrometre length scales – where the capillary theory is expected to break down – remains poorly understood. Grazing incidence X-ray scattering experiments on ID10B allowed a complete determination of the free surface structure and surface energy for water and a range of organic liquids (Fradin *et al.*, 2000). The interface between two liquids, where the role of surface energy is significantly reduced, may be different from the gas/liquid interface.

Low dimensional Physics. Langmuir and Gibbs monomolecular layers at the air/liquid interface are good models for studying thermodynamic phase transitions and structure of two dimensional systems. From the very beginning, the Troika beamline was involved in studies of phase transitions in fatty alcohols (Berge *et al.*, 1994; Legrand *et al.*, 1994) and effects of chirality on structural self organisation (Alonso *et al.*, 2001).

Crystalline structural biology. Protein structure determination by classical X-ray crystallography requires three dimensional crystals that can be challenging to obtain for many proteins and especially for membrane bound proteins. An alternative is to grow 2D crystals by adsorbing proteins on ligand-lipid monolayers at the surface of water. This confined geometry requires only small amounts of material and offers numerous advantages (*e.g.* fully hydrated proteins, possibility to observe them in action). Surface scattering techniques are unique tools in resolving the structure of 2D protein

crystals. Pioneering studies of 2D structures of several proteins were carried out at Troika (Lenne *et al.*, 2000). The importance of this subject increased with the recent demonstration on ID10B of the possibility to achieve subatomic resolution in the structure determination of 2D organic crystals formed at gas/liquid interface (Pignat *et al.*, 2006).

Biomimetic self-assembled systems. Langmuir layers are suitable model systems to mimic cell membranes through the precise control of lipid and protein composition and its structural organisation whilst keeping the natural biological activity. The Langmuir technique is used at ID10B to study structural and elastic aspects of interactions of antimicrobial peptides with bacterial and mammalian cell membranes (Konovalov *et al.*, 2002; Gidalevitz *et al.*, 2003; Saint Martin *et al.*, 2006) and neural cell adhesion and cellular tissue formation (Johnson *et al.*, 2005; Martel *et al.*, 2002). A wide horizon is open in this field with the possibility of studying liquid/liquid interfaces.

Materials science. Monolayers of functional surfactants at the gas/liquid interfaces yield unique opportunities to use them as organic templates for the growth of organic, inorganic and composite materials at the interface. Series of *in situ* studies of nucleation and growth of metal sulphide semiconductor on polydiacetylene Langmuir film were essential to elucidate the role of polydiacetylene in the determination of morphology, orientation and growth rate of the deposited materials (Lifshitz *et al.*, 2006).

Techniques

ID10B is a multi-purpose, high brilliance undulator beamline for high resolution X-ray surface scattering and diffraction on solid and particularly liquid interfaces, including buried interfaces (liquid/solid and liquid/liquid). The characteristic length scales range from sub-nanometre to 100 nm, in some cases even up to 1000 nm. Scattering experiments can be performed in both horizontal and vertical scattering geometries. Whereas the horizontal scattering geometry is exploited for liquid surfaces (with a Langmuir trough) and heavy sample environments (such as *in situ* UHV chambers), the vertical scattering geometry can be used for lightweight sample environments when a large angular access is required. A broad range of X-ray experimental techniques with a variable resolution and detection scheme (via point or linear detectors) is available on a single instrument, *e.g.*:

- Grazing incidence diffraction (GID);
- Grazing incidence diffuse scattering (GIS);
- Grazing incidence small angle X-ray scattering (GISAXS);
- X-ray reflectivity (XRR);
- High resolution X-ray diffraction (HXRDX);
- Total reflection X-ray fluorescence (TXRF).

Surface sensitive techniques applied to soft condensed matter will remain the key activity of Troika-II with emphasis on the field of buried liquid interfaces. So far grazing incidence techniques had limited applications to time-resolved studies because of relatively long measurement times (> tens of minutes) due to step by step scanning. One way to collect the data much faster is to replace the scanning techniques by the simultaneous acquisition of the entire scattering pattern on a large two dimensional (2D) detector. The application of 2D detectors for GID has inherent limitations due to the small grazing angles. For example, the foot print of a 100 micron beam on the sample surface at a grazing angle of 2 mrad is 50 mm. The latter together with the 0.5 m sample to detector distance, a detection angle of ~20 degrees and a pixel size of ~0.1 mm gives an angular resolution of several degrees. This is insufficient to resolve Bragg rods with a width less than 0.1 degree and separated by a distance of less than a degree. The resolution problem can be overcome by reducing the beam size down to 4 microns via focusing (flux is essential to measure a 10^{-11} signal) but still maintaining a low divergence (< 50 micro radians) to be surface sensitive. This is why we are developing non-scanning techniques by introducing focusing optics to achieve low divergence and a beam size of a few microns at the same time. However, further improvements are now limited by the present performance of the double crystal diamond monochromator that adds divergence to the beam. This problem could be solved by replacing the thin diamond crystals by thicker silicon crystals, which implies a splitting of the ID10B and ID10A/C branches at the source level by using two in-vacuum canted undulators. The availability of fast 2D detection systems and small beam sizes in grazing incidence experiments will naturally open the field of time-resolved studies presently missing in the field of soft condensed matter surface science. An additional advantage of fast non-scanning techniques is the reduction of radiation damage effects that are important at third-generation synchrotron radiation facilities. Micrometre size beams with low divergences are particularly essential for high energy studies of buried interfaces. Silicon (111) has a bandwidth two times larger than diamond (111) and matches better the horizontal source divergence. Hence, the replacement of diamond by silicon will increase both the beam quality and the total flux. The present GISAXS capabilities of ID10B are limited by the very small sample-to-wall distance in the experimental hutch (< 0.9 m).

Context with new sources and user community

The application of the grazing incidence scattering techniques to structural studies on "soft interfaces" (surfaces and interfaces of soft condensed matter materials/system) has steadily increased over the last decade both at the ESRF and at national synchrotron sources. For example the D41B beamline at LURE increased the beam time devoted to GID on liquid interfaces from 30% in 1997 to 100% in 2001 but nevertheless the demand remained substantially higher than the available beamtime until the shutdown of LURE. We notice the same growing demand at the Troika-II beamline with an over subscription of a factor of two or more. To satisfy the needs of the user community several new European national synchrotron sources (SOLEIL, ALBA, and DIAMOND) plan to operate beamlines dedicated to liquid surfaces studies by grazing incidence techniques.

However, thanks to the higher brilliance of the ESRF in the high energy range (compared to most other European sources) the proposed upgrade will keep Troika-II at a leading position in the field by providing access to a new, almost unexplored area - buried liquid interfaces using energies between 20 to 26 keV. Nowadays, buried solid/liquid interfaces are studied mostly with neutrons due to their high penetration abilities. However, low neutron flux limits the accessible momentum-transfer range. This is why a high energy option at ID10B could attract research groups used to neutron facilities. At the moment there is no neutron facility providing instrumentation for liquid/liquid interfaces. Therefore the possibility to study such systems with high energy X-rays will become especially fascinating. The improvement in beam quality by moving from thin diamond crystals to silicon based optics (high brilliance, micrometre size, low divergence) will allow implementation of non-scanning techniques, which reduce the measuring time and increase the throughput of the beamline.

Technical considerations

The whole complex of the Troika beamlines will benefit from the change to independent canted undulators.

Benefits for ID10B:

- Increase of monochromator flux throughput, specifically in the high energy range due to installation of upstream lenses to match source divergence and monochromator angular acceptance;
- Improvement of the beam focusing from the present 100 micrometres down to 3 to 5 micrometres via use of non-transparent high quality silicon

monochromator crystals;

- Extension of the high energy range up to 26 keV which is essential for studies of buried interfaces;
- Increase of sample to detector distance from the present 800 mm to a few metres to increase resolution in GISAXS and to accommodate bulky sample environments and large area two dimensional detectors;
- Implementation of non scanning techniques;
- Possibility to operate in anomalous scattering mode.

Apart from the continuation of the effective sharing of the staff and individual expertise in technical and scientific domains, there are additional organisational and technical advantages for all Troïka branches:

- Elimination of interference between the beamlines during change of energy and optics settings – no longer necessary to synchronise the beginning and end of experiments at the two beamlines;
- Improvement of the beam quality for Troïka I and III with respect to coherence and flux due to remove of the splitting monochromator that absorbs 30% to 50% of the beam and degrades the coherence.

The technical aspects of the proposed modifications are:

- Installation of a UHV chamber with a set of compound refractive lenses (CRL), both one and two dimensional, operating in the white beam upstream of the monochromator to match beam divergence and monochromator crystal acceptance;
- A complete redesign and manufacturing of a UHV compatible double crystal Si monochromator system yielding one metre offset of the monochromatic beam with respect to the white beam. To achieve this a two metre long high precision translation stage of the second crystal is required;
- Installation of two UHV vessels in the monochromatic beam with a set of remotely controlled beryllium CRL, which can be used as zoom lenses to tune beam size and divergence on the sample in the entire energy range;
- Non-scanning techniques will require large area two dimensional detectors with high quantum efficiency.

According to our experience a precise control of the humidity in the experimental hutch is absolutely necessary to avoid vapour condensation on the windows of the chamber containing large area liquid sample. Dust particles on the liquid sample distort the flatness of the surface and, if they get in the X-ray beam path, they spoil the scattered signal completely. Special care must therefore be taken to construct the experimental hutch with control of temperature, relative humidity and dust levels.

References

- Alonso C., Artzner F., Suchod B., Berthault M., Konovalov O., Pecaut J., Smilgies D., and Renault A. (2001), Two and three dimensional stacking of chiral

alcohols, *J. Phys. Chem. B.*, **105**, 12778-12785.

- Berge B., Konovalov O.V., Lajzerowicz J., Renault A., Rieu J.P., and Vallade M. (1994), Melting of Short 1-Alcohol Monolayers on Water: Thermodynamics and X-Ray Scattering Studies, *Phys. Rev. Lett.*, **73**, 1652-1655.
- Fradin C., Braslau A., Luzet D., Smilgies D., Alba M., Boudet N., Mecke K., and Daillant J. (2000), Reduction in the Surface Energy of Liquid Interfaces at Short Length Scales, *Nature*, **403**, 871-874.
- Gidalevitz D., Ishitsuka Y., Muresan A.S., Konovalov O., Waring A.J., Lehrer R.I., and Lee K.Y.C. (2003), Interaction of antimicrobial peptide protegrin with biomembranes, *Proc. Natl. Acad. Sci. USA*, **100**, 6302-6307.
- Johnson C.P., Fragneto G., Konovalov O., Dubosclard V., Legrand J.-F., and Leckband D.E. (2005), Structural Studies of the Neural-Cell-Adhesion Molecule by X-ray and Neutron Reflectivity, *Biochemistry*, **44**, 546-554.
- Konovalov O., Myagkov I., Struth B., and Lohner K. (2002), Lipid discrimination in phospholipid monolayers by the antimicrobial frog skin peptide, PGLa. A Synchrotron X-ray grazing incidence and reflectivity study. *Europ. Biophys. J.*, **31**, 428-437.
- Konovalov O., Saint-Martin E., Daillant J., Luzet D., and Padmanabhan V. (2005), New possibilities at ID10B: high energy for surface studies at liquid/liquid interfaces, *ESRF Newsletter*, **41**, 22.
- Legrand J.F., Renault A., Konovalov O.V., Chevigny E., Als-Nielsen J., Grubel G., and Berge B. (1994), X-ray grazing incidence studies of 2D crystallization of monolayers of 1-alcohols at the air-water interface, *Thin Solid Films*, **248**, 95-99.
- Lenne P.F., Berge B., Renault A., Zakri C., Venien-Bryan C., Courty S., Balavoine F., Bergsma-Schutter W., Brisson A., Grubel G., Boudet N., Konovalov O.V., and Legrand J.F. (2000), Synchrotron radiation diffraction from two-dimensional protein crystals at the air/water interface, *Biophys. J.*, **79**, 496-500.
- Lifshitz Y., Konovalov O., Belman N., Berman A., and Golan Y. (2006), Template Growth of Nanocrystalline PbS, CdS, and ZnS on a Polydiacetylene Langmuir Film: An *in situ* Grazing Incidence X-ray Diffraction Study, *Advanced Functional Materials*, **16**, 2398-2404.
- Martel L., Johnson C., Boutet S., Al-Kurdi R., Konovalov O., Robinson I., Leckband D., and Legrand J.F. (2002), X-ray reflectivity investigations of two-dimensional assemblies of C-cadherins: First steps in structural and functional studies, *J. Phys. IV France*, **12**, 365-371.
- Pignat J., Daillant J., Leiserowitz L., and Perrot F. (2006), Grazing Incidence X-ray Diffraction on Langmuir Films: Toward Atomic Resolution, *J. Phys. Chem. B.*, **110**, 22178-22184.
- Saint Martin E., Konovalov O., and Daillant J. (2006), Studies of Phospholipid Monolayer at Liquid/Liquid Interface in Presence of an Antimicrobial Peptide, *Thin Solid Films*, **515**, 5687-5690.

HISAXS: High Throughput Small Angle X-ray Scattering

Summary

A new bending magnet beamline is proposed with an emphasis on high throughput SAXS/WAXS solution scattering on topics ranging from proteins, soft condensed matter to materials science and chemistry. The beamline should provide turn key operation including mail-in data collection services and online data analysis capabilities. An important aspect would be to foster on-site and partnership collaborations as well as provide test beamtime in the context of long term projects or grant applications.

Scientific case

Overview

Structural Biology: there is a growing demand for high throughput solution scattering experiments on proteins, which often does not require an undulator beamline but a very stable setup and online data analysis techniques. Solution scattering data are of particular interest for understanding the structure, association and aggregation of proteins, which are difficult or cannot be crystallised (Svergun, 2000 and 2003). This applies, for example, to the formation of many fibrillar proteins such as amyloidic fibrils (Thiyagarajan *et al.*, 2000).

Soft Condensed Matter and Functional Biology: heavy over booking of public soft condensed matter beamlines with proposals requiring the highest possible brilliance does mean that novel science and user groups are often lost to the ESRF. In addition, novel techniques, such as microfluidics, require considerable test beam time, which is difficult to schedule at the highly demanded undulator beamlines. A core bending magnet SAXS/WAXS beamline would provide more flexibility in beam time allocation, which is of particular interest for soft condensed matter beamlines such as ID02 and ID13.

Chemistry and Materials: a beamline optimised for solution scattering would be the ideal place for a strong research and development programme on microfluidic reactors. One application, as an example, would be the high temperature synthesis of CdSe nanocrystals (Chan *et al.*, 2003 and 2005). Such topics could be best developed in the context of a long term project if enough test beam time were available. The beamline would also be of interest for scanning high-throughput catalyst libraries in order to systematically check for parameters such as porosity (Kaneko *et al.*, 2003).

Organisation:

We propose to reduce the fraction of scheduled user beamtime to about one-third and to increase correspondingly several other modes of access:

- **proprietary research:** an attractive price per shift should be offered in case the bending magnet beam time is coupled with beam time on one of the undulator beamlines. This could attract companies interested in screening experiments prior to using a high brilliance beamline. A mail-in data collection service should be available for these applications.
- **partnerships** with external groups and on-site institutes such as the Partnership for Structural Biology, the Grenoble Outstation of the European Molecular Biology Laboratory, the Institut Laue Langevin and the Institut de Biologie Structurale. test beam time for long term proposals
- **in-house** research and development.

Techniques

The aim is to develop a highly automated bending magnet beamline with turn key operation capability, optimised for high quality SAXS/WAXS experiments and, in particular, high throughput solution scattering. A sample changer with an integrated scanner would allow the mapping of pellet libraries for combinatorial chemistry (Senkan and Ozturk., 1999), microfluidic chips and chip arrays (Pfohl *et al.*, 2003) and online chromatography for protein fractionation (Mathew *et al.*, 2004).

The ESRF is well prepared for these developments as several work packages by a consortium of European third-generation SAXS beamlines including the ESRF

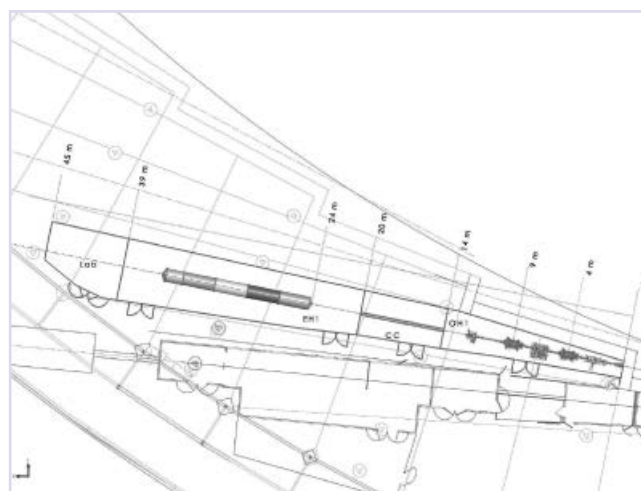

Figure 1: Possible layout of HISAXS bending magnet beamline with optics hutch (OH1), spacious SAXS hutch (EH1), annex control cabin and sample preparation laboratory. The distances are relative to the exit of the shielding wall (~22 m from the X-ray source).

within the FP6 SAXIER grant (www.saxier.org) are directly related to the HISAXS proposal. Thus an integrated software system for solution scattering allowing automated data analysis is being developed at EMBL Hamburg. Online gel filtration techniques for macromolecular solutions are being developed at SOLEIL (the SWING beamline). Microfluidic systems are being developed at IBR-Graz/ELETTRA (the Austrian SAXS beamline) and at ESRF ID13/ID10B. High-throughput data reduction routines for solution scattering are available at ID02 (www.esrf.eu/UsersAndScience/Experiments/SCMatter/ID02/BeamlineDescription/DataReduction) and for solid polymers/biopolymers at ID13 (Davies, 2006).

A possible layout of the beamline is shown in **Figure 1**. The beamline would be equipped with a tuneable channel cut monochromator and a complimentary double multilayer monochromator. The aim will not be to reach the smallest Q-values but to find a compromise between flux density and Q-range using 1:2 demagnifying optics. Focusing could be based either on mirror optics or on beryllium refractive lens optics or a combination of both providing the highest possible stability and the lowest background. A particularly interesting focusing optics combining stability and focal spot tunability could be crossed refractive beryllium lenses in combination with a planar mirror for energy cut off.

In view of the low background requirements, 2D gas filled detectors (*e.g.* Bruker) are currently the best choice. This might evolve as pixel detectors become available. Separate detectors for SAXS and WAXS would be available. The vacuum tube between sample and detector would be up to 10 m long in order to provide a range of Q-values.

Context with new sources and user community

Bending magnet SAXS/WAXS beamlines are installed at all European synchrotron radiation sources. The availability of new sources such as PETRA-III and DIAMOND does not make these beamlines obsolete. A highly automated and high throughput SAXS/WAXS beamline will even be constructed at DIAMOND. This shows that undulator SAXS/WAXS beamlines cannot cover the full range of SAXS/WAXS applications.

Technical considerations

Most technical solutions have already been developed on ESRF undulator beamlines. The development of linear refractive beryllium lenses could be handled within the ESRF nanotechnology platform.

Support facilities

The beamline will require an integrated laboratory for the testing of sample environments and standard sample preparation facilities. Access to ancillary laboratories specialising in rheology, spectroscopy (light scattering, IR, Raman...), microfluidics and biology will be required. These could be located in a Soft Condensed Matter Partnership structure, for example jointly with the Institut Laue Langevin.

References

- Chan E.M., Alivisatos A.P., and Mathies R.A. (2005), High Temperature Microfluidic Synthesis of CdSe Nanocrystals in Nanoliter Droplets, *J. Am. Chem. Soc.*, **127**, 13854-13861.
- Chan E.M., Mathies R.A., and Alivisatos A.P. (2003), Controlled Growth of Semiconductors Nanocrystals in Microfluidic Reactors, *Nanoletters*, **3**, 199-201.
- Davies R. (2006), A new batch-processing data-reduction application for X-ray diffraction data, *J. Appl. Cryst.*, **39**, 267-272.
- Kaneko E.Y., Pulcinelli S.H., Santilli C.V., Craievich A.F., and Chiaro S.S.X. (2003), Characterization of the porosity developed in a titania-alumina catalyst support prepared by the sol-gel route, *J. Appl. Cryst.*, **36**, 469-472.
- Mathew E., Mirza A., and Menhart N. (2004), Liquid-chromatography-coupled SAXS for accurate sizing of aggregating proteins, *J. Synch. Rad.*, **11**, 314-318.
- Pfohl T., Mugele F., Seemann R., and Herminghaus S. (2003), Trends in Microfluidics with Complex Fluids, *Chem. Phys. Chem.*, **4**, 1291-1298.
- Senkan S.M. and Ozturk S. (1999), Discovery and Optimization of Heterogeneous Catalysts Using Combinatorial Chemistry, *Angew. Chem. Int. Ed.*, **38**, 791-795.
- Svergun D.J. (2000), Advanced solution scattering data analysis methods and their applications, *J. Appl. Cryst.*, **33**, 530-534.
- Svergun D. and Koch M. (2003), Small-angle scattering studies of biological macromolecules in solution, *Rep. Prog. Phys.*, **66**, 1735-1782.
- Thiagarajan P., Burkoth T.S., Urban V., Seifert S., Benzinger T.L.S., Morgan D.M., Gordon D., Meredith S.C., and Lynn D.G.J. (2000), pH dependent self assembly of β -amyloid(10-35) and β -amyloid(10-35)-PEG3000, *J. Appl. Cryst.*, **33**, 535-539.

MINADIF: Micro- and Nano-Diffraction

Summary

The proposed project aims at the provision of two independently operating branches for micrometre and

nanometre sized beams for SAXS/WAXS and complimentary techniques such as μ Raman, μ X-ray fluorescence (μ XRF). With the proposed project new research opportunities spanning the range from micrometre to nanometres sized beams will be established from which a wide user community, in particular soft condensed matter (SCM), functional and structural biology (MX), will benefit.

Microbranch

- A highly flexible branch for μ SAXS/WAXS;
- Single crystal and scanning techniques down to about 0.5 μ m beam size;
- Automation of scanning techniques including online data analysis tools;
- Rapid turnover of special equipment such as optical tweezers, stretching cells, etc.;
- Integrated μ Raman setup with short and medium focal distance optical heads;
- Online μ XRF setup;
- Integrated laboratory with confocal Raman microscope.

Nanobranh

- A research and development branch for nanodiffraction and complimentary techniques;
- Single crystal and scanning techniques down to 50 nm and less;
- Use of coherent, divergent nanometre sized beams
- nanotomographies: *e.g.* SAXS tomography, XRF tomography;
- Integrated nanoimaging and nanomanipulation: AFM, near-field optics, nanofluidics;
- Integrated laboratory with nanoimaging and nanomanipulation tools.

Scientific case

Overview

History: small and wide angle X-ray scattering (SAXS/WAXS) techniques with micro and nanobeams have been developed at the microfocus (ID13) beamline (Riekkel, 2000). Beam sizes proposed for user experiments currently span the range from 5 μ m to 300 nm and 50 nm spot sizes have been demonstrated (Schroer, 2005).

Applications: scientific applications cover a wide range of hierarchically organised materials with an emphasis on polymers and biopolymers. Techniques used allow both top-down analysis (scanning μ SAXS/WAXS) as well as bottom-up analysis (single crystal μ diffraction). Micro- and nano-beams are used in polymer science (*e.g.* scanning μ SAXS/WAXS on bulk polymers - Zafeiropoulos *et al.*, 2005), functional biopolymers (*e.g.* *in vivo* silk extrusion from spiders - Riekkel and Vollrath, 2001), single crystal microdiffraction on proteins (*e.g.* amyloid fibres -

Nelson *et al.*, 2005) and small unit cell compounds (*e.g.* kaolinite - Neder *et al.*, 1996). Complimentary techniques, such as μ XRF (Flynn *et al.*, 2006) or μ Raman (Davies *et al.*, 2005), are available to users. ID13 has also been involved in research and development on many X-ray focusing devices (*e.g.* waveguides - Jark *et al.*, 1996). The interest of the community in these techniques has led to the installation of microdiffraction beamlines or end-stations at several European third-generation synchrotron radiation sources for soft condensed matter (SCM), functional biopolymers or macromolecular crystallography (MX).

Beamline characteristics: a characteristic feature of the ID13 beamline is its high flexibility allowing experiments with complex sample environments such as: stretching, indentation, microfluidics etc. New sample environments, such as optical tweezers (Amenitsch *et al.*, 2006), are constantly being commissioned. In addition, complimentary tools for microfluorescence (μ XRF) and μ Raman are proposed for user experiments.

During the first part of 2007 the new ID13 nanofocus end-station has started developing science and instrumentation for beams of 50 nm and smaller, which will have a high degree of coherence. The end-station has been optimised for stability and precise movements, which implies highly specialised sample environments.

Many user experiments will, however, continue to require an end-station with a 0.5 to 1 μ m beam and a flexible sample stage. A highly automated beamline control and online data collection routines are recurrent requirements from user groups, which are not specialised in synchrotron radiation experiments. This is typical for cultural heritage applications such as archeological/historical Chinese silk gowns (Hermes *et al.*, 2006).

Microbeams also provide, in general, access to smaller q-values than nanobeams, which can be important for the study of hierarchical materials.

Proposal: it is proposed to split the ID13 beamline into two independently operating branches thus providing the possibility of a better adaptation to the specific user requirement. A close collaboration between both branches should, however, be maintained. Research and development on both branches can be defined as follows:

- **Microbranch (0.5 to 1 μ m beams):** for complex sample environments with optimum optical sample observation tools. This applies, for example, to the field of microfluidics, which is closely linked to microrheology (Waigh, 2005) The development of microfluidic technologies will allow development of

new approaches in biomimetics (artificial silks - Vollrath and Knight, 2001, artificial muscles - Geoghegan *et al.*, 2006). μ SAXS/WAXS data collection should be highly automated including online "image" generation from which microscopic information can be extracted (Riekell and Davies, 2005; Davies, 2006; Gourrier *et al.*, 2006). Rapid information on local structures is of interest for polymeric materials (*e.g.* composites) and biomaterials (*e.g.* bones, biomineralisation). Research and development will develop more and more towards *in situ* techniques, which require special setups (*e.g.* microindentation - Gourrier *et al.*, 2005); microdrop - Rössle, *et al.*, 2003). Complimentary online techniques, such as X-ray fluorescence (Berlund *et al.*, 1999) and μ Raman (Davies *et al.*, 2005) will be available. μ Raman can provide local molecular information in combination with μ SAXS/WAXS experiments (Davies *et al.*, 2006). Single crystal μ diffraction will be an integral part of the microbranch. ID13 has thus recently demonstrated single crystal protein μ diffraction with an about $1 \times 1 \mu\text{m}^2$ beam (Moukhametzianov, *to be published*). This will allow systematic exploration of the Henderson limit for proteins and biopolymers (Henderson, 1990) ID13 is ideally placed for exploring the limits of single crystal microdiffraction, which requires a different approach than high throughput crystallography performed on the MX beamlines. It is, however, evident that such topics will increase the potential for collaboration between ESRF groups but will also require long term external collaborations.

- **Nanobranch (50 to 500 nm beams):** As for μ SAXS/WAXS in the past, one can expect that completely new fields of applications will develop with nanobeams. Many current μ SAXS/WAXS experiments will, however, also profit from the higher positional resolution of nanobeams. This has already been shown by the use of 300 nm beams on ID13 for the study of hierarchical materials such as bones or the interfaces between spherulitic materials. Nano-SAXS/WAXS will require the implementation of specialised nanotools such as nanoindentation. This will allow, for example, studies of local strain fields in biominerals. Nano-GISAXS has already been performed at ID13 with a 300 nm beam (Roth, *to be published*). It is tempting to speculate that this technique could be applied to cell membranes. Nanobeam experiments will, however, also develop towards 3D imaging via nano-XRF techniques or nano-SAXS tomography (Schroer *et al.*, 2006). Research and development in this area will extend our know-how on skin core layers in synthetic polymers and the complex morphologies of biopolymers. Finally, the use of coherence will become an important aspect for applications such as magnifying diffraction imaging (DiFonzo *et al.*, 2000) or phase projection microscopy (Pfeiffer *et al.*, 2003). The aim should be to visualise domains of a few tens of nanometres size, which are common to many polymer and biopolymer architectures.

Techniques

Nanobeams will be generated by various nanofocusing optics such as KB mirrors, KB refractive lenses, Fresnel lens systems, waveguides etc. Each focusing system to be installed at the nanofocus end-station will be integrated into an "optics package" including alignment and beam defining elements. "Optics packages" can be exchanged via a common interface structure located together with the sample goniometer on a common granite support structure. The sample goniometer is composed of a horizontal air bearing x/y scanning system, an air bearing rotation axis and a mini-hexapod with nanometre positional accuracy. The mini-hexapod will serve for scanning and alignment purposes including nano-GISAXS. Microscopy and AFM tools will be integrated into the setup. The detection system will be positioned via a robotic arm (or equivalent) allowing large amplitude (≤ 2.5 m) linear movements (SAXS/WAXS) and angular movements (single crystal or GISAXS). Complimentary XRF detection and possibly a near-field Raman will be available. The number of vacuum windows in the beamline will be minimised in order to optimise coherent scattering. The high flux density of nanobeams will induce extreme radiation damage problems, which will require optimising signal to noise ratios as far as possible, the use of "stitching" techniques and to speed up data collection in order to minimise secondary radiation damage. This will also require the use of a vacuum chamber with a cryo-stage.

Microbeams will be generated by KB mirror optics and/or parabolic refractive beryllium lenses. A combination of both is currently in use at ID13. The sample stage will be highly modular and comprise an x/y/z module with optional air bearing rotation stage. SAXS/WAXS experiments will be performed in scanning mode with integrated optical alignment and sample positioning stages. A large area 2D detector (*e.g.* CCD or equivalent) will be installed on a linear translation stage with 2.5 m stroke. Automated data reduction routines will allow the generation of online "images" based on specific parameters (WAXS intensities, Invariant...) from mesh scans using peak fitting routines. An online μ Raman system and an XRF detector will be integrated into the setup.

Context with new sources and user community

Several μ SAXS/WAXS beamlines, end-stations or μ MX beamlines are to be installed or operational at European third-generation synchrotron radiation sources:

- DIAMOND: μ SAXS/WAXS end-station; μ MX beamline;

- SOLEIL: μ SAXS/WAXS beamline and μ SAXS/WAXS end-station;
- PETRA-III: μ /nanoSAXS/WAXS-beamline and μ MX beamline;
- BESSY-II: μ SAXS/WAXS end-station;
- ALBA: μ SAXS/WAXS end-station.

The micro- and nano-branch of the MINADIF proposal puts forward a range of beam sizes and experimental possibilities not available in this combination at national facilities. The close association of both branches would provide a high flexibility in user operation. An increase of beamtime for long term proposals and partnership collaborations could be envisaged in view of complex research and development projects in functional biology and soft condensed matter requiring extended preparation and testing periods and the interaction of several groups. The proposed SAXS bending magnet beamline (CDR HISAXS) will also be an important asset for ESRF with respect to such projects.

Technical considerations

There are no particular new technical challenges for the proposed project. The ID13 beamline nanofocus end-station started its commissioning period at the beginning of 2007. Setting aside the splitting up of the beamline into two branches by using canted undulators, the main modification will be an increase of the distance of the nanofocus extension hutch from currently about 100 m (optics position) to about 140 m at the (for example) ID31 location (Figure 1). This will provide more flexibility in reaching the smallest spot sizes but also in increasing the optics to sample distance for complex sample environments requiring space. The ID13 nanofocus goniometer (to be commissioned from September 2007) will be the most advanced scanning diffractometer ever installed at the ESRF and will allow new concepts of sample positioning and manipulation to be tested.

The nanobranch will be equipped with a channel-cut monochromator providing the possibility for energy tuning and a multilayer monochromator for pink beam applications. Whether the microbranch will be operated at a fixed energy or with a variable energy is open for discussion. A fixed energy of about 13 keV would be sufficient for most SCM-applications and provide the highest beam stability. A double crystal setup would provide tunability for μ XRF and anomalous dispersion applications. It would, however, require an extended travelling range of the second crystal. Thus for a Si(111) crystal placed at 1 m laterally from the nanobranch beam, the travelling range would be 2.4 m for 8 to 17keV.

The availability of nanofocusing optics has to be assured. At the current stage, the ESRF has a

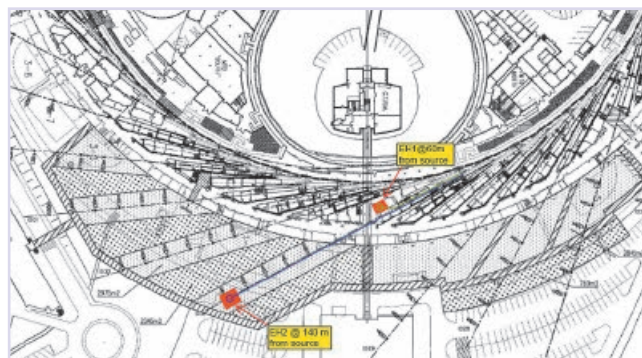

Figure 1: Possible location of the microbranch (EH1) at 60 m and the nanobranch (EH2) at 140 m from the low- β undulator source for the ID31 position.

competitive KB mirror technology for nanofocus applications and nanofocus refractive lenses are at an advanced commissioning stage. Other optical systems (e.g. Fresnel, waveguides, capillaries) should, however, also become available as standard beamline components through international collaborations.

Support facilities

Microbranch

Support laboratory: sample manipulation, preparation and visualising tools: optical microscopy, micromanipulators etc. The laboratory will also house a confocal Raman setup.

Nanobranch

Support laboratory: sample manipulation, preparation and visualising tools: optical microscopy, AFM, near-field techniques etc.

On-site nanotechnology laboratory: electron microscopy (SEM, TEM), focused ion beam (FIB), laser cutting; sample manipulation: microlithography and sputtering techniques; support facilities for testing and integration of nanotools (e.g. nanoindenter).

Both branches

Ancillary laboratories: for advanced sample environments: optical tweezers, microfluidics, inkjet systems, mechanical testing, rheology, indentation. These laboratories would principally serve the SCM Group but would also be accessible to other beamlines and groups. The labs should be close to the SCM Group beamlines and could be an integral part of a SCM partnership structure.

Biology laboratories: access to standard analytical biology techniques available in the Partnership for Structural Biology.

References

- Amenitsch H., Cojoc D., Rappolt M., Sartori B., Laggner P., Ferrari E., Garbin V., Burghammer M., Riekel C., and Fabrizio E.D. (2007), Optical Tweezers for

Sample Fixing in Micro-Diffraction Experiments, *AIP Conf. Proc.*, **879**, 1287-1290.

- Berlund A., Brelid H., Rindby A., Engström P. (1999), Spatial distribution of metal ions in spruce wood by synchrotron radiation microbeam x-ray, *Holzforschung*, **53**, 474-480.
- Davies R. (2006), A new batch-processing data-reduction application for X-ray diffraction data, *J. Appl. Cryst.*, **39**, 267-272.
- Davies R., Burghammer, M., and Riekkel C. (2006), Simultaneous micro-Raman spectroscopy and microfocus X-ray diffraction, *Macromolecules*, **39**, 4834-4840.
- Davies R., Burghammer M., and Riekkel C. (2005), Simultaneous microRaman and synchrotron radiation microdiffraction: Tools for materials characterization, *Appl. Phys. Lett.*, **87**, 264105-264101 - 264105-264103.
- DiFonzo S., Jark W., Lagomarsino S., Giannini C., DeCaro L., Cedola A., and Müller M. (2000), X-ray waveguides as high resolution microscope objectives: 100 nm lateral resolution for the non-destructive determination of local strain under buried interfaces, *Nature*, **403**, 638-640.
- Flynn G.J., Bleuet P., Borg J., Bradley J.P., Brenker F.E., Brennan S., Bridges J., Brownlee D.E., Bullock E.S., Burghammer M., Clark B.C., Dai Z.R., Daghlian, C.P., Djouadi Z., Fakra S., Ferroir T., Floss C., Franchi I.A., Gainsforth Z., Gallien J.-P., Gillet P., Grant P.G., Graham G.A., Green S.F., Grossemy F., Heck P.R., Herzog G.F., Hoppe P., Hörz F., Huth J., Ignatyev K., Ishii H.A., Janssens K., Joswiak D., Kearsley A.T., Khodja H., Lanzirotti A., Leitner J., Lemelle L., Leroux H., Luening K., MacPherson G.J., Marhas Kuljeet K., Marcus M.A., Matrajt G., Nakamura T., Nakamura-Messenger K., Nakano T., Newville M., Papanastassiou D.A., Pianetta P., Rao W., Riekkel C., Rietmeijer F.J.M., Rost D., Schwandt C.S., See T.H., Sheffield-Parker J., Simionovici A., Sitnitsky I., Snead C.J., Stadermann F.J., Stephan T., Stroud R.M., Susini J., Suzuki Y., Sutton S.R., Taylor S., Teslich N., Troadec D., Tsou P., Tsuchiyama A., Uesugi K., Vekemans B., Vicenzi E.P., Vincze L., Westphal A.J., Wozniakiewicz P., Zinner E., and Zolensky M.E. (2006), Elemental Compositions of Comet 81P/Wild 2 Samples Collected by Stardust, *Science*, **314**, 1731-1734.
- Geoghegan M., Ruiz-Pérez L., Dang C.C., Parnell A.J., Martin S.J., Howse J.R., Jones R.A. L., Golestanian R., Topham P.D., Crook C.J., Ryan A.J., Sivia D.S., Webster J.R.P., and Menelle A. (2006), The pH-induced swelling and collapse of a polybase brush synthesized by atom transfer radical polymerization, *Soft matter*, **2**, 1076-1080.
- Gourrier A., Gutiérrez M.C.G., and Riekkel C. (2005), Investigation of the Structural Deformation Mechanisms induced by Microindentation in a Thermotropic Liquid Crystalline Copolyester using Synchrotron X-ray Microdiffraction, *Macromolecules*, **38**, 3838-3844.
- Gourrier A., Wagenmaier W., Burghammer M., Lammie D., Gupta H.S., Fratzl P., Riekkel C., Wess T.J., and Paris O. (2007), Scanning X-ray imaging with small-angle scattering contrast *J. Appl. Cryst.*, **40** (Supplement), s78-s82.
- Henderson R. (1990), Cryo-Protection of Protein Crystals against Radiation Damage in Electron and X-Ray Diffraction, *Proc. Roy. Soc. B*, **241**, 6-8.
- Hermes A.C., Davies R.J., Greiff S., Kutzke H., Lahli S., Wyeth P., and Riekkel C. (2006), Characterising the decay of ancient silk fabrics by microbeam synchrotron radiation diffraction, *Biomacromolecules*, **7**, 777-783.
- Jark W., DiFonzo S., Lagomarsino S., Cedola A., Fabrizio E. D., Bram A., and Riekkel C. (1996), Submicrometre resolution phase-contrast radiography with the beam from an X-ray waveguide, *J. Appl. Phys.*, **80**, 4831-4836.
- Moukhametzianov R., Burghammer M., Edwards P., Fransen M., Petidmange S., Popov D., Rieke, C., and Schertler, G. to be published.
- Neder R.B., Burghammer M., Grasl T., Schulz H., Bram A., Fiedler S., and Riekkel C. (1996), Single crystal diffraction by submicrometer sized kaolinite; observation of Bragg reflections and diffuse scattering, *Zeitschrift f. Kristallographie*, **211**, 763-765.
- Nelson R., Sawaya M.R., Balbirnie M., Madsen A., Riekkel C., Grothe R., and Eisenberg D. (2005), Structure of the cross- β spine of amyloid-like fibrils, *Nature*, **435**, 773-778.
- Pfeiffer F., David C., and Salditt T. (2003), 1D and 2D X-ray waveguides: Optics and applications, *J. Phys. IV*, **104**, 211-216.
- Riekkel C. (2000), New avenues in x-ray microbeam experiments, *Rep. Prog. Phys.*, **63**, 233-262.
- Riekkel C. and Davies R. (2005), Applications of synchrotron radiation micro-focus techniques to the study of polymer and biopolymer fibers, *Current Opinion in Colloid & Interface Science*, **9**, 396-403.
- Riekkel C. and Vollrath F. (2001), Spider silk fibre extrusion: combined wide- and small-angle X-ray microdiffraction experiments, *Int. J. Mol. Biol.*, **29**, 203-210.
- Rössle M., Flot D., Engel J., Riekkel C., and Chanzy H. (2003), Fast Intracrystalline Hydration of β -Chitin Revealed by Combined Microdrop Generation and On-Line Synchrotron Radiation Microdiffraction, *Biomacromolecules*, **4**, 981-986.
- Schroer C.G., Kuhlmann M., Roth S.V., Gehrke R., Stribeck N., and Lengeler B. (2006), Mapping the local nanostructure inside a specimen by tomographic small-angle X-ray scattering, *Appl. Phys. Lett.*, **88**, 164102.
- Schroer C.G., Kurapova O., Patommel J., Boye P., Feldkamp J., Lengeler B., Burghammer M., Riekkel C., Vincze L., Hart A.v.d., and Kuchler M. (2005), Hard x-ray nanoprobe based on refractive x-ray lenses, *Appl. Phys. Lett.*, **87**, 124101-124103.
- Vollrath F. and Knight D.P. (2001), Liquid crystalline spinning of spider silk, *Nature*, **410**, 541-548.
- Waigh T.A. (2005), Microrheology of Polymeric Solutions using X-ray Photon Correlation Spectroscopy, *Rep. Prog. Phys.*, **68**, 685-742.
- Zafeiropoulos N., Davies R.J., Roth S.V., Burghammer M., Schneider K., Riekkel C., and Stamm M. (2005), Microfocus X-Ray Scattering Scanning Microscopy for Polymer Applications, *Macromol. Rapid Comm.*, **26**, 1547-1551.

SAXS: Small Angle X-ray Scattering

Summary

The possible evolution of the small-angle scattering beamline (ID02) is described. The new beamline not only enhances the performance of conventional techniques such as small-angle X-ray scattering (SAXS), wide-angle X-ray scattering (WAXS) and ultra small-angle X-ray scattering (USAXS) but also introduces non-traditional scattering and imaging methods. The emphasis will be on quantitative scattering experiments which together with advanced sample environments and data analysis methods could open new avenues in soft matter, non-crystalline structural biology, material and environmental sciences.

Scientific case

Overview

Soft matter and many biological materials possess a microstructure that responds easily to an external deformation (Lubensky, 1997). Scattering techniques are ideally suited for probing these structures which often extend to multiple levels. Developments over the last decade have promoted applications of SAXS and related techniques such as WAXS and USAXS in soft matter and non-crystalline structural biology (Narayanan, 2007). Scattering experiments are often combined with a variety of thermophysical and rheological techniques. As a result, not only are equilibrium structures revealed but also non-equilibrium dynamics can be studied down to the sub-millisecond range. For instance, quantitative scattering experiments have allowed probing rapid growth kinetics in very dilute systems (volume fraction $< 10^{-6}$) (Beaucage *et al.*, 2004) and low contrast samples (Weiss *et al.*, 2005).

Despite the significant progress over the last decade, scattering methods are somewhat overshadowed by the parallel advancements in real space (*e.g.* confocal microscopy) (Leunissen *et al.*, 2005) and manipulation techniques (*e.g.* optical tweezers) (Grier, 2003). The success of these techniques can be largely attributed to the ability to design appropriate model systems and data analysis based on advanced computer simulations. Nevertheless, real space methods are susceptible to various artefacts and have limitations when quantitative structural or kinetic information is desired. As a result, scattering techniques remain essential for quantitative studies. The most powerful approach is to combine scattering and real space methods in a complementary fashion.

In order to make scattering techniques more attractive, not only are instrumental developments desired but a major emphasis on designing model systems and formulating advanced data analysis methods based on analytical theories and computer simulations are also required. The latter aspects necessitate much broader and interactive collaboration between the user community and large facilities.

In the following, representative fields are outlined, in which scattering techniques are likely to remain dominant in the coming decades.

Soft matter: microstructure and non-equilibrium dynamics

Soft matter physics continues to pose new experimental and theoretical challenges. Understanding the complex phase behaviour and underlying microstructures is crucial in resolving these issues. Many soft matter systems are composed of highly self-organised complex macromolecules. Although the equilibrium structure of a large variety of such systems has been widely investigated, the kinetic pathways of self-assembly remain largely unexplored (Robinson, 2003). Examples include surfactants, block copolymers, and lipid-biopolyelectrolytes (*e.g.* DNA, actin, etc.) complexes. In addition, a comprehensive understanding of soft matter self-assembly is primordial in many nano/biotechnological applications. The true character of soft matter is best demonstrated when driven out of equilibrium (*e.g.* in shear flows). The relationship between macroscopic rheology and microscopic structure and dynamics is reasonably well understood in homopolymer and model colloidal systems (Larson, 1999). However, self-assembled block copolymer or amphiphilic systems and anisotropic colloids impose fresh questions some of which can be readily addressed using combined shear flow and scattering experiments. Soft matter in complex flows (*e.g.* in a microfluidic environment) has been little explored by synchrotron scattering methods. Recently, the different kinetically arrested states in systems dominated by competing repulsive and attractive interactions (*e.g.* globular proteins) have received considerable attention (Sciortino and Tartaglia, 2005). In this case, scattering experiments together with appropriate theoretical modelling can provide new insights (*e.g.* the enigma of long-ranged forces in globular protein solutions).

Non-crystalline structural biology: structure-function relationships

The key advantage of SAXS for studying biological systems is that it can provide physiologically relevant structural information. The widely studied system is muscle where a molecular level understanding of the structure and mechanical function can be reached (Piazzesi *et al.*, 2002). Similar investigations are being

extended to excitable membranes (*e.g.* axonal membranes in nerve) and many other soft tissues. The success of these studies critically depends on the improvement in scattering detection, since the structural changes are rapid and at the same time samples are very susceptible to radiation damage. Other topics include protein-protein interactions, folding and conditions for protein crystallisation and self-assembly.

Biomimetic and bio-inspired self-assembled systems: structure and kinetics

This is an interdisciplinary area between soft matter and biology and involves extremely complex systems (Bar-Cohen, 2005). One of the less understood questions is how self-assembly brings unique structural and dynamical features which are different from their building blocks. Time-resolved scattering allows one to learn about the recipes optimised by Mother Nature over millions of years. The underlying problems (*e.g.* biomineralisation) involve multiple length and timescales. A combination of USAXS, SAXS and WAXS techniques reveals a wealth of structural information in biomimetic systems (Valery *et al.*, 2003). These studies can address questions such as how the kinetic competition in the self-assembly process leads to structures with unique mechanical properties (*e.g.* biological tissues, bones, etc.).

Green chemistry and environmental sciences: chemical reactions and open non-equilibrium systems

New material synthesis largely depends on novel synthetic routes which are often constrained by increased environmental concerns. A way to overcome this issue is to perform the reactions in miniature volumes (*e.g.* microfluidic devices) (Chan *et al.*, 2005). Scattering techniques offer interesting possibilities in monitoring such reactions in nanoscale and thereby allowing conditions to be optimised. In environmental sciences, the control of aerosols resulting from the combustion of fossil fuels is a major issue. Recently, synchrotron scattering experiments have been used to elucidate the mechanism of particle nucleation and the formation of multiscale structures in open non-equilibrium conditions (*e.g.* spray pyrolysis, exhaust of a diesel engine, etc.) (Beaucage *et al.*, 2004). In this case, an appropriate combination of SAXS and USAXS provides insight to structural development from a few nanometres to micron scale.

Techniques

Combined SAXS and WAXS

The aim is to improve the detection limit of these techniques to unprecedented levels. In the SAXS range, the present limit is of the order of 0.1% of water scattering (10^{-6} mm^{-1}) (Narayanan, 2007). An improvement by an order of magnitude would allow more quantitative investigations of dilute and

radiation sensitive samples, increase the time resolution in kinetic studies and the recording of weak scattering features of low contrast samples. Advanced data analysis methods will be crucial for exploiting these technical developments. These improvements would also benefit anomalous scattering methods applied to soft matter systems.

USAXS

Bonse-Hart USAXS has now emerged as a matured technique providing a high intensity dynamic range ($> 10^8$), low background, absolute intensity scales and high scattering vector (q) resolution ($\Delta q \sim 10^{-3} \text{ nm}^{-1}$) (Narayanan, 2007). It is important to maintain this technique as complimentary to SAXS and light scattering. However, this is a scanning method which provides only one dimensional scattering profile. Therefore, it is desirable to have a long pinhole USAXS instrument with similar q resolution and intensity dynamic range of a Bonse-Hart camera. This instrument will be suitable for investigating ordered samples with lattice spacing in the micron range (*e.g.* photonic crystals), self-organised growth kinetics in non-equilibrium systems (*e.g.* spray pyrolysis) and radiation sensitive biological specimens (*e.g.* protein complexes, tissues, etc.). The long pinhole camera will also be useful for performing SAXS at high energies and extending ASAXS to small q values. In addition, the combination of USAXS and imaging will be a powerful approach to study hierarchically ordered systems in medical applications (Levine and Long, 2004).

Near-field X-ray scattering (NFXS)

In the optical region, near-field scattering has been demonstrated as a viable alternative to conventional scattering methods (Ferri *et al.*, 2004). This technique is based on the analysis of heterodyne speckle formed by the mixing of strong transmitted and scattered beams. The scattered intensity is given by the power spectrum of the fluctuating component of the recorded signal (Ferri *et al.*, 2004). A key advantage of this approach is that it provides direct access to the scattering amplitude as opposed to intensity in conventional scattering methods. This technique is complimentary to USAXS and extends the q range to an order of magnitude lower (10^{-4} nm^{-1}).

Context with new sources and user community

Upcoming sources such as DIAMOND, PETRA-III, SOLEIL, etc. have dedicated SAXS/WAXS beamlines. Whilst these new beamlines attempt to incorporate advanced technology, there is less emphasis on the quantitative aspects of SAXS techniques. In this respect, ID02 is unique in Europe for highly quantitative synchrotron SAXS/WAXS/USAXS

experiments. In addition, USAXS is a specialised technique which requires some experience to reach the same data quality as that currently obtained at ID02.

The present user community is very diverse and during the last several years, more than sixty proposals were received per allocation period. Only about 30 to 35% of these proposals were awarded beamtime and in some cases with a significantly reduced number of shifts than those requested. With the introduction of new methods such as NFXS, the diversity of the user community is likely to broaden. The number of proposals from existing users is also likely to increase if there is more beamtime available and advanced data analysis tools are provided.

Technical considerations

At present, the main limiting factor for SAXS techniques is the detector. A two dimensional detector with adequate sensitivity, spatial and time resolution, and dynamic range is not yet available. The scientific exploitation of the existing and future beamlines largely depends on the availability of a suitable detector. To overcome this bottleneck, a significant investment will be required. Pixel array detectors seems to offer a promising future scenario but to fulfil the SAXS requirements, the detector should have a defect free detecting area and read out structure, fast read out and stable continuous operation at high count rates. Direct coupled CCD based detectors have the advantage of higher spatial resolution and maintenance free operation for a longer period, which make them a workhorse detector for SAXS. However, to realise adequate sensitivity and detection area, a system based on the tiling of four or more large CCDs (fibre optic coupled or three side buttable) will be required. This could be realised as a continuation of the ongoing CCD detector developments at the ESRF. High count rate

gas detectors still remain as an option for time-resolved SAXS experiments. For the NFXS, high spatial resolution ($1 \mu\text{m}$) and dynamic range ($> 10^5$) are essential but the high signal level (transmitted beam) makes it possible to compromise on efficiency.

Focusing optics capable of fully maintaining the low emittance and the stability of the source is critical for USAXS and high resolution SAXS. This is another aspect requiring more efforts since the currently attainable figure errors and mechanical stability of focusing mirrors do not permit reaching close to the ideal source divergence and size. Refractive optics has the disadvantage of higher background, absorption and dispersion. As a result, the reflective optics is still preferred for SAXS and USAXS applications.

The potential applications of long pinhole USAXS instrument include probing transient processes in dilute systems, long-range correlations in plasmas, metastable emulsions, large biological complexes, etc. As a result, the parasitic background of the instrument needs special consideration. In order to gain significant improvements over the existing pinhole instrumentation ($\Delta q \sim 3 \times 10^{-3} \text{ nm}^{-1}$ and $q_{\text{Min}} \sim 6 \times 10^{-3} \text{ nm}^{-1}$ in the vertical direction), for the given source size and divergence, the sample to detector distance has to be increased to 40 to 50 m. This means that to curtail the parasitic background and thereby allowing a reasonable beamstop size ($\sim 3 \text{ mm}$; $q_{\text{Min}} \sim 2 \times 10^{-3} \text{ nm}^{-1}$), the optical elements have to be placed at 40 to 50 m distance before the sample (Narayanan, 2007). As a result, the length of the beamline will have to be more than 110 m. The pinhole USAXS setup would use a magnifying focusing optics (1:2) which demagnifies the beam divergence and allows to obtain $\Delta q \sim 1.5 \times 10^{-3} \text{ nm}^{-1}$ with low background. A high intensity dynamic range ($> 2^{18}$) two dimensional detector will be essential for covering a wide q range. In addition, the beam centre should be stable to

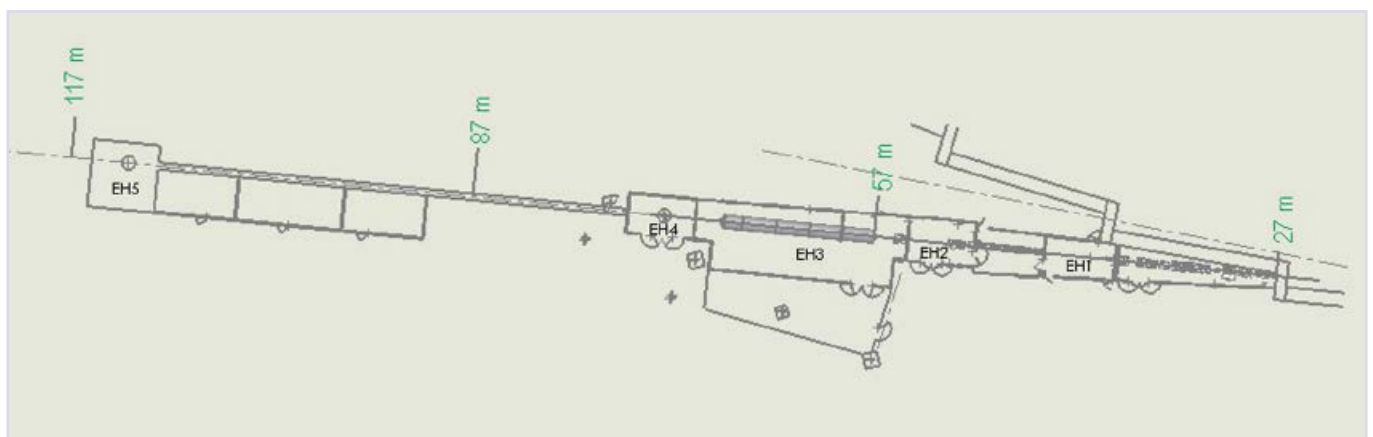

Figure 1: Schematic layout of the proposed beamline for SAXS/WAXS and USAXS applications. Scattering setups NFXS, Bonse-Hart and combined SAXS/WAXS are located in EH1, EH2 and EH3, respectively. The long pinhole USAXS instrument extends from EH4 (sample) to EH5 (detector).

within 0.5 mm at the beamstop position. For strongly scattering colloidal crystalline systems, there is an alternative scheme for high angular resolution studies (Petukhov *et al.*, 2006). This method would also gain by having a longer sample to detector distance.

Figure 1 presents the schematic layout depicting the experimental stations for NFXS, Bonse-Hart USAXS, SAXS/WAXS and long pinhole USAXS instruments. Experimental hutches (EH) 2 and 3 (Bonse-Hart and SAXS/WAXS instruments, respectively) are similar to the existing beamline. To preserve the coherence for NFXS in EH1, it is proposed to use an unfocused monochromatic beam. The channel cut crystals of the Bonse-Hart setup (EH2) could be used to condition the beam for the long pinhole USAXS instrument located in EH4 and EH5. In the USAXS q-range, it is important to discriminate the contributions to scattering and diffraction from reflection and refraction (crossover region). For this purpose, the Bonse-Hart instrument will be a good diagnostic tool.

Finally, it should be recognised that the high quality data produced by these SAXS instruments can be quantitatively exploited only if there are appropriate data analysis tools.

Support facilities

Advanced laboratories for sample environments, sample preparation and pre-characterisation are required. The sample environment and preparation laboratories need to be attached to the beamline. The laboratory for sample characterisation could be within the soft matter infrastructure on-site. Required facilities include static and dynamic light scattering, high precision rheology, confocal microscopy, etc. Development of data analysis will rely on a dedicated computing environment located close to instruments.

References

- Bar-Cohen Y. (2005) (Ed.), *Biomimetics: Biologically Inspired Technologies* (CRC Press).
- Beaucage G., Kammler H.K., Strobel R., Mueller R., Pratsinis S.E., and Narayanan T. (2004), Probing the dynamics of nanoparticle growth in a flame using synchrotron radiation, *Nature Materials*, **3**, 370-373.
- Chan E.M., Alivisatos A.P., and Mathies R.A. (2005), High-Temperature Microfluidic Synthesis of CdSe Nanocrystals in Nanoliter Droplets, *J. Am. Chem. Soc.*, **127**, 13854-13861.
- Ferri F., Magatti D., Pescini D., Potenza M.A.C., and Giglio M. (2004), Heterodyne near-field scattering: A technique for complex fluids, *Phys. Rev. E*, **70**, 041405.
- Grier D.G. (2003), A revolution in optical manipulation, *Nature*, **424**, 810-816.
- Larson R.G. (1999), *The Structure and Rheology of*

Complex Fluids (Oxford University Press, Oxford).

- Leunissen M.E., Christova C.G., Hynninen A.-P., Royall C.P., Campbell A.I., Imhof A., Dijkstra M., van Roij R., and van Blaaderen A. (2005), Ionic Colloidal crystals of oppositely charged particles, *Nature*, **437**, 235-240.
- Levine L.E. and Long G.G. (2004), X-ray imaging with ultra-small-angle X-ray scattering as a contrast mechanism, *J. Appl. Cryst.*, **37**, 757-765.
- Lubensky T.C. (1997), Soft condensed matter physics, *Solid State Comm.*, **102**, 187-198.
- Narayanan T. (2007), *Synchrotron Small-Angle X-Ray Scattering in "Soft Matter: Scattering, Imaging and Manipulation"*, Vol III, Eds. R. Borsali and R. Pecora (Springer).
- Petukhov V., Thijssen J.H.J., Hart D.C., Imhof A., van Blaaderen A., Dolbnya I.P., Snigirev A., Moussaid A., and Snigireva I. (2006), Microradian X-ray diffraction in colloidal photonic crystals, *J. Appl. Cryst.*, **39**, 137-144.
- Piazzesi G., Recondit M., Linari M., Lucii L., Sun Y.-B., Narayanan T., Boesecke P., Lombardi V., and Irving M. (2002), Mechanism of force generation by myosin heads in skeletal muscle, *Nature*, **415**, 659-662.
- Robinson B.H. (2003) (Ed.), *Self-Assembly*, (IOS Press, Amsterdam).
- Sciortino F. and Tartaglia P. (2005), Glassy colloidal systems, *Adv. Phys.*, **54**, 471-524.
- Valery C., Paternostre M., Robert B., Gulik-Krzywicki T., Dedieu J.-C., Keller G., Narayanan T., Torres M.-L., Cherif-Cheikh R., Calvo P., and Artzner F. (2003), Biomimetic organization: Octapeptide self-assembly into nanotubes of viral capsid-like dimension, *Proc. Natl. Acad. Sci. USA*, **100**, 10258-10262.
- Weiss T.M., Narayanan T., Gradzielski M., Panine P., Finet S., and Helsby W. (2005), Dynamics of the Self-Assembly of Unilamellar Vesicles, *Phys. Rev. Lett.*, **94**, 038303.

XPCS-CXS: X-ray Photon Correlation Spectroscopy and Coherent X-ray Scattering

Summary

The ID10A and ID10C stations specialise in applications of coherent X-ray scattering and X-ray photon correlation spectroscopy (XPCS), including coherent SAXS and coherent diffraction imaging (CDI). As the coherent properties of the beam are degraded by the multiplexed ID10B side station, we propose to separate these branches into two independent beamlines and to reconstruct them on a sector (*e.g.* ID28) where sufficient floor space (width and length) is available. The coherence beamline described here will use in-vacuum undulator technology on a canted branch (*e.g.* ID28A) and host two experimental stations.

Scientific case

Overview

Soft Condensed Matter is a scientific field characterised by its extremely diverse character and crosses borders between the classical disciplines such as physics, chemistry and biology. Typically, the length scales of interest in soft matter range from ~ 1 nm to $10\ \mu\text{m}$ and hard X-ray scattering experiments are performed in the small angle regime. X-ray, (visible) light and neutron scattering have contributed with pioneer work in soft condensed matter, *e.g.* colloidal, polymer and liquid crystal sciences. In addition, scattering experiments continue to provide new insights into liquid surfaces/interfaces and thin film studies. The dynamics of soft matter can be relatively slow (~ 1 ns to 1000 s) due to its hydrodynamic character and the mesoscopic length scales involved. Topics such as gelation, jamming and the glass transition continue to receive considerable amounts of interest beyond the usual soft matter community.

Scattering Experiments with Coherent Light enable the dynamics on distinct length scales to be followed by characterising the temporal evolution of the speckle pattern at various momentum transfers, Q . For length scales above $1\ \mu\text{m}$ this can be achieved by dynamic light scattering (DLS) of visible laser light, a standard technique in soft matter science. Since 1994 the ID10A team has pioneered the use of coherent X-rays to perform dynamics measurements by X-ray photon correlation spectroscopy (XPCS) (Grübel *et al.*, 2007), the X-ray counterpart to DLS. XPCS has the obvious advantages of smaller wavelength (larger possible Q), no multiple scattering, penetration power, surface sensitivity, etc. The drawbacks are the limited coherent flux compared to optical lasers and the difficulty of having an efficient and fast XPCS detector. Over the years, the efficiency of XPCS experiments on ID10A has increased by almost two orders of magnitude due to reduced machine emittance and improved beamline optics. Soft matter is often subject to beam induced damage and therefore the high flux imposes new experimental challenges in reducing the dose received by the sample without compromising the quality of the acquired data.

X-ray Photon Correlation Spectroscopy (XPCS) highlights from ID10A constitute the foundation for the scientific case of the new beamline. Recently, several experiments have addressed non-equilibrium dynamics, which is only possible by multi-speckle XPCS using a fast, high resolution and high sensitivity 2D detector (Caronna *et al.*, 2006). Interestingly, common dynamic phenomena known as *jamming* and *aging* are observed in fundamentally different systems such as *colloidal glasses* (Robert *et al.*,

2006) and *gels* (Fluerasu *et al.*, 2007). The study of interactions and dynamics in colloidal systems was, from the very beginning, an active research field at the beamline and here XPCS continues to provide new insights. Recent highlight examples include studies of magneto-hydrodynamics in *ferrofluids* (Robert *et al.*, 2006), many-body interactions in *charge stabilised suspensions* (Banchio *et al.*, 2006) and *microrheology* by nanoparticle tracer diffusion in complex fluids (Papagiannopoulos *et al.*, 2005). Recently, XPCS was used to study equilibrium *bulk fluctuations in a lyotropic lamellar phase* (Constantin *et al.*, 2006). *Surface dynamics* is another topic where XPCS was successfully applied with the beam impinging at the surface under grazing angles to study capillary waves and surface diffusion (Madsen *et al.*, 2005; Streit *et al.*, 2007). XPCS has also been used in grazing incidence geometry to characterise the dynamic modes of *smectic liquid crystal membranes* (Sikharulidze *et al.*, 2005) and references therein for a complete overview). In parallel with the ongoing soft matter applications, there have also been many successful XPCS experiments in hard condensed matter. Recent examples comprise the study of mixing and unmixing kinetics and *diffusion in alloys* (Pfau *et al.*, 2006) and critical dynamics related to *ordering* (Ludwig *et al.*, 2005) and *displacive transitions* (Ravy *et al.*, 2007).

Coherent Diffraction Imaging (CDI), also denoted X-ray diffraction microscopy, was initiated during 2006. Working with XPCS, the ID10A team has gained considerable experience in tailoring coherent X-ray beams and using them for CDI experiments. Up to now, three user experiments have been successfully conducted in close collaboration with the ID10A team. Here, the high degree of coherence in the setup is used to record static speckle patterns, which, if taken under the right conditions, can be inverted by a phase retrieval algorithm to obtain the real space structure. Recently, 17 nm resolution was demonstrated in CDI experiments with 5 keV X-rays at SPRING-8 (Miao *et al.*, 2006). The scientific case for CDI in the SAXS regime includes problems of border line feasibility for electron diffraction and optical microscopy (for example 3D nanoimaging of single cells and bacteria (Shapiro *et al.*, 2005) and hierarchical structures such as collagen and cellulose). CDI has also been applied to map out strain fields inside nanocrystals by recording speckles around the Bragg reflections (Pfeifer *et al.*, 2006). The applications of anomalous and polarisation effects still need to be developed for CDI and XPCS, for instance to study magnetic structures in the future.

There is still a large unexplored potential for XPCS, both when it comes to attracting new user groups and concerning the possible site developments (for example the Soft Matter Partnership with ILL). With the forthcoming machine and detector upgrades it is believed that XPCS will expand its capabilities to

even weaker scattering objects, for instance enabling the study of biological samples which, nowadays, is at the borderline of feasibility. Beam damage will become an increasing problem and it is important that the new beamline has a better performance at 12 to 18 keV than it does presently. CDI is still largely unexplored in the soft-matter and bio-domains where there is a huge development potential, as well as in the study of (buried) interfacial structures.

Techniques

X-ray Photon Correlation Spectroscopy (XPCS) will remain a key activity at the proposed new beamline. Since it is not restricted to any particular scattering geometry it is important that the upgraded beamline remains very versatile with SAXS, WAXS and GID capabilities. This is best accomplished by having two experimental hutches. At present XPCS is detector limited, especially for SAXS and GID applications: the available, CCD-based area detectors have insufficient frame rates. We anticipate that, in the future, pixel detectors will become the standard detector for XPCS. Their larger pixel size must be taken into account in the beamline design, as it puts requirements on the minimum sample to detector distance. For the fastest timescales, APD detectors with 1 ns dead time are required and the storage ring must operate in uniform filling mode.

Coherent Diffraction Imaging (CDI) experiments have, in general, quite different requirements to coherence and flux than XPCS. It is essential to fine tune the Q-resolution and the field of view in a CDI experiment to fulfil the over sampling criterion. This requires a large, movable area detector at a distance up to ~7 m from the sample. Optimum focusing and beam tailoring is crucial for CDI, and an increased source to sample distance would increase the exploitable Q-range of the beamline towards smaller Q, allowing studies of micrometre sized structures.

In summary, we propose to reconstruct the ID10A/C stations with a larger source to sample distance, larger experimental hutches on an independent beamline without the upstream semi-transparent ID10B diamond monochromator (which distorts the wavefront).

Context with new sources and user community

Several coherent scattering beamlines will become operational in Europe within the next five years. There are detailed plans at SLS (under commissioning), PETRA III (beamline approved), DIAMOND (beamline approved) and SOLEIL (several beamlines planning to include coherence

techniques). This will certainly boost the field as such, but also significantly sharpen the competition within Europe. In the 7 to 12 keV range, the coherent flux of the new sources will be comparable to that of the ESRF.

The ESRF will retain its competitive advantage if it capitalises on the following points:

- The ESRF already has extensive know how in all the technical fields related to coherent X-rays, in particular optics, detection and vibration control.
- The ID10A team pursues an in house research programme 100% devoted to the applications of X-ray coherence in condensed matter science (dynamics and more recently imaging) in close collaboration with leading European institutes and universities.
- The ESRF caters to a very diverse user community and covers many different scientific fields. Cross fertilisation between them has led to the emergence of new applications for XPCS and CDI (for example in biophysics, chemistry and biology).
- The different soft condensed matter activities at the ESRF could be grouped sensibly in terms of space and co-ordination in order to profit from shared laboratory facilities, preparation areas, etc and from idea and development sharing. Transverse links between groups have already started, particularly between this proposal and the Macromolecular Crystallography Group proposal **MX-BIB** for a biology imaging beamline based on coherent diffraction imaging.
- A fast track beam time application could be useful to promote activities during the critical start-up phase of a serious ESRF push on coherent diffraction techniques. This could allow rapid testing of foundation technology.
- The idea of a Soft Condensed Matter Partnership including the ILL should be strongly supported.

Technical considerations

Significant advances in coherence techniques for soft matter applications will require the building of a new dedicated beamline. The multiplexing of a side branch onto the XPCS beamline should be avoided for the following reasons:

- The upstream, semi-transparent monochromator degrades the X-ray wave front and thus decreases the coherence of the beam.
- The type and operational settings of insertion devices, ring-side optics, primary slits, etc, can be optimised, whereas on a multiplexed beamline a compromise has to be found for all optical elements up to the beam splitter.

These advantages could be realised if the two Troika branches, ID10A/C and ID10B were to share a sector as canted beamlines. The downside of this arrangement is a reduction in (coherent) flux.

Nowadays, the limiting factor for XPCS on ID10 is mostly the detector (size, speed, efficiency). The rapid development of a new generation of pixel detectors is therefore the most urgent need.

Further problems may arise from beam induced sample damage. This effect can be minimised by a judicious choice of the photon energy. We envisage to extend the energy range over which an intense, coherent beam can be delivered to 7 to 18 keV. This requires a redesign of the beamline optical scheme, which today is optimised for ~8keV. An end-station should be constructed in the proposed new experimental hall extension, at a distance of approximately 110 m from the source. In this hutch up to 7 m detector-sample distance must be foreseen. A submicron precision positioning system with sphere of confusion to the order of 100 nm is required for manipulation of micron sized samples, as well as an on-axis sample viewing system with high resolution.

An upstream hutch (~55 m from the source) should house a six circle diffractometer with heavy load capacity for coherent WAXS and GID purposes. Keeping a layout with two hutches will provide the maximum flexibility in choosing energy, beam size, and scattering geometry for every XPCS and CDI experiment. Both stations will have extended focusing capabilities (7 to 16 keV), including the possibility to define a secondary "coherent" source by double focusing in a so-called eye-piece geometry that exploits the chromaticity of compound refractive lenses. Such operation is clearly favourable at an extended beamline providing the optimum of flexibility and source-sample distance. All optical components must be of the highest possible quality in order to control and tailor the wave front from source to sample. Windowless operation should be an option.

Specialised online data visualisation and data reduction tools need to be integrated into the beamline operation system. In designing optics, instrumentation and the two hutches, special care must be taken to eliminate vibrations and electrical noise which are the worst enemies of XPCS and CDI.

References

- Banchio A.J., Gapinski J., Patkowski A., Häubler W., Fluerau A., Sacanna S., Holmqvist P., Meier G., Lettinga M.P., and Nägele G. (2006), Many-Body Hydrodynamic Interactions in Charge-Stabilized Suspensions, *Phys. Rev. Lett.*, **96**, 138303.
- Caronna C., Chushkin Y., Fluerau A., Ponchut C., and Madsen A. (2006), Multi-speckle XPCS using a pixelated 2D detector, <http://www.esrf.eu/news/spotlight/spotlight39/spotlight39xpcs/>.
- Constantin D., Brotons G., Salditt T., Freyssingas E., and Madsen A. (2006), Dynamics of bulk fluctuations in a

lamellar phase by coherent X-ray scattering, *Phys. Rev. E*, **74**, 031706.

- Fluerau A., Moussaïd A., Madsen A., and Schofield A. (2007), Dynamics during a transient gelation process studied by XPCS, *Phys. Rev. E*, **76**, 010401(R).
- Grübel G., Madsen A., and Robert A. (2007), X-ray Photon Correlation Spectroscopy (XPCS) in Soft Matter Scattering, Imaging and Manipulation; Borsali, R.; Pecora, R. (Eds.), Springer.
- Ludwig K.F., Livet F., Bley F., Simon J.-P., Caudron R., Le Bolloc'h D., and Moussaïd A. (2005), XIFS Studies of Ordering Kinetics in a Cu-Pd Alloy, *Phys. Rev. B*, **72**, 144201.
- Madsen A., Seydel T., Tolan M., and Grübel G. (2005), Grazing incidence scattering of coherent X-rays from a liquid surface, *J. Sync. Rad.*, **12**, 786-794.
- Miao J., Chen C.-C., Song C., Nishino Y., Kohmura Y., Ishikawa T., Ramunno-Johnson D., Lee T.-K., and Risbud S.H. (2006), Three-dimensional GaN-Ga₂O₃ core shell structure revealed by X-ray diffraction microscopy, *Phys. Rev. Lett.*, **97**, 215503.
- Papagiannopoulos A., Waigh T.A., Fluerau A., Fernyhough C., and Madsen A., (2005), Microrheology in Polymeric Solutions using XPCS, *J. Phys.: Condens. Matter*, **17**, L279.
- Pfau B., Stadler L.-M., Sepiol B., Weinkamer R., Kantelhardt J.W., Zontone F., and Vogl G. (2006), Coarsening dynamics in elastically anisotropic alloys, *Phys. Rev. B*, **73**, 180101.
- Pfeifer M.A., Williams G.J., Vartanyants I.A., Harder R., and Robinson I.K. (2006), Three-dimensional mapping of a deformation field inside a nanocrystal, *Nature*, **442**, 63-66.
- Ravy S., Le Bolloc'h D., Currat R., Fluerau A., Mocuta C., and Dkhil B. (2007), The SrTiO₃ displacive transition revisited by coherent X-ray diffraction, *Phys. Rev. Lett.*, **98**, 105501.
- Robert A., Wandersman E., Dubois E., Dupuis V., and Perzynski R. (2006), Glassy dynamics and aging in a dense ferrofluid, *Europhys. Lett.*, **75**, 764-770.
- Shapiro D., Thibault P., Beetz T., Elser V., Howells M., Jacobsen C., Kirz J., Lima E., Miao H., Neiman A.M., and Sayre D. (2005), Biological imaging by soft x-ray diffraction microscopy, *Proc. Natl. Acad. Sci. USA*, **102**, 15343-15346.
- Sikharulidze I., Dolbnya I.P., Madsen A., and de Jeu W.H. (2005), XPCS in a reflection geometry: coherence and resolution, *Optics Communications*, **247**, 111-124.
- Streit S., Gutt C., Chamard V., Robert A., Sprung M., Sternemann H., and Tolan M. (2007), Two-dimensional dynamics of metal nano-particles on the surface of thin polymer films studied with coherent X-rays, *Phys. Rev. Lett.*, **98**, 047801.

Introduction to the Conceptual Design Reports of the Surface and Interface Science Group

The three Conceptual Design Reports of the Surface and Interface Science (SIS) Group build upon the present strengths and capabilities of the three beamlines ID01, ID03 and ID32, which will be very strongly enhanced. Surface Science has always been nanoscience by definition, with one relevant dimension being on the nanometre scale. The consequent upgrade of the three beamlines proposed here will allow routine sample characterisation with resolution in all three dimensions on the nanometre scale.

Surface science is traditionally multidisciplinary. The three CDRs are relevant for soft matter and biology (*e.g.* in view of hard matter/soft matter interfaces and functionalisation of surfaces). An important issue will be the investigation of structure and chemistry in view of catalysis. Self-organisation and/or band structure tailoring via surface stress can be studied, as well as dynamic and electronic properties induced or modified by nanostructuring. The CDRs will have a strong bearing on fundamental (*e.g.* self organisation) and applied science (*e.g.* microelectronic devices).

The **SURF** CDR represents a strongly accelerated evolution of the capabilities of the surface diffraction beamline ID03, which has just recently been completely refurbished and newly commissioned. Accessing the time dependence of catalytic reactions and micrometre sized surface features are the key aspects of this CDR.

The **CDI** CDR represents an important and consequent upgrade of the scientific potential of beamline ID01 allowing the (lensless) diffraction

imaging of nanometre scale objects, based on coherent microdiffraction, phase retrieval and oversampling.

The **HXPM** CDR demands a complete rebuild of ID32. Whilst retaining the present X-ray standing wave (XSW), X-ray photoelectron spectroscopy (XPS) and surface X-ray diffraction (SXRD) capabilities, the realisation of this CDR will allow hard X-ray photoelectron spectroscopy (HAXPES) on the nanometre scale. This requires a significant increase of the length of the beamline in order to obtain chemical and electronic information with ~30 nanometre resolution, complementary to absorption or fluorescence spectroscopy.

The three CDRs will lead to a highly attractive European synchrotron (hard) X-ray centre in surface and interface science, with the ability to routinely tackle problems in nanoscience and nanotechnology. This centre would be unique in Europe, since a concerted effort in surface and interface science is not foreseen at the upcoming second European third-generation hard X-ray machine (PETRA-III).

The extended buildings and renewed infrastructure created as the consequence of the ESRF Upgrade Programme will allow the synergy of existing surface science equipment to be enhanced and the present equipment to be extended to prepare, handle and use complementary techniques to characterise nanometre sized samples. The CDRs can only be successfully put into practice with the accompanying advancements in X-ray optics, mechanical stability and detector technology, as well as the envisaged improvement in machine performance.

Summary of individual CDRs

| | | |
|-------------|---|---------|
| CDI | Coherent X-ray Diffraction Imaging and Microdiffraction: Extending lensless coherent X-ray diffraction imaging to the nanoscale. | page 68 |
| HXPM | Hard X-ray Photoelectron Microscopy: Chemical and electronic characterisation by hard X-ray photoelectron spectroscopy on the nanoscale. | page 72 |
| SURF | Surface Diffraction: Extending surface X-ray diffraction into the time domain and to micron sized objects. | page 74 |

CDI: Coherent Diffraction Imaging and Microdiffraction

Summary

The proposed project will establish new research opportunities on ID01, from which a wide user community will benefit:

- Provide an upgraded instrument with a stable beam for μ -X-ray diffraction (μ -XRD) and to use the coherence of the beam;
- Provide trained staff and modular setups to support user demands with sub- μ m and coherent diffraction experiments (static and dynamic speckle analysis);
- Provide sample positioning routines with nm resolution;
- Develop analysis routines for μ -XRD data from individual objects;
- Provide a chamber for sputter erosion, thin film deposition and annealing for *in situ* studies using the sub- μ m focused beam and surface sensitive X-ray photon correlation spectroscopy (XPCS) on nanometre length scales.

The current high flux option for anomalous small angle X-ray scattering (SAXS) and wide angle X-ray scattering (WAXS) will remain fully available to ID01 users.

As the characteristic dimensions of semiconductor devices decrease into the regime of self-organised nanostructures with sizes of about 100 nm, advanced characterisation tools are crucial in understanding and controlling their properties. To this end, several different routes using synchrotron radiation have been pursued. X-ray diffraction measurements on large nanostructure ensembles have been very successful in determining shape, chemical composition and strain distribution. On the other hand, the focusing of X-rays has now progressed to beam diameters below the 100 nm range with their partial coherence being exploited for a model free conversion of reciprocal space intensity distribution to the real space sample structure. So far, this has been mainly used in coherent diffraction imaging of almost strain free micro- and nano-particles.

This project aims to combine these different approaches for the characterisation of single semiconductor nanostructures. We would like to push the conventional analysis methods into the nanobeam regime, and expand the capabilities of coherent diffraction so that it will yield not only shape and size, but also internal strain and extended defects in nanostructures, by measuring an individual and particular object using the focused nanobeam. For this purpose, ID01 will be significantly upgraded with new optical elements, and experimental equipment.

The X-ray results can then be correlated with the results from other techniques on the same object. The new setup will also open up other possibilities such as X-ray photon correlation spectroscopy to study critical fluctuations in confined geometries and nanostructure evolution at various time and length scales, making the facility attractive to a large user community.

Scientific case

Overview

Nanomaterials, *i.e.* materials being different from their bulk phase due to the small size, are within the focus of intense research. The progress in nanoscience and nanotechnology requires tools to characterise the structure of objects both on the mesoscopic and atomic levels. This is especially relevant in semiconductor devices based on heterostructures, where the user community together with ID01 have already developed techniques to study the average structural properties of large ensembles of nanostructures ("quantum structures"). One big challenge in this field is the investigation of individual nanostructures, which is important in quantifying differences in self-assembled structures and to correlate these differences with the particular nanostructure location on the sample. This will be increasingly relevant for nanostructures embedded into electronic devices.

In order to reach this goal, we propose to refurbish ID01 to obtain a sub-micron focused beam. In microfocus experiments, real space mapping (*i.e.* some analogy to a scanning point-probe image of the surface) at a constant scattering vector (specific for the nanostructure) will be combined with diffraction experiments in reciprocal space. This will allow the strain, size and chemical composition of individual nanostructures to be measured with the methods developed for large nanostructure ensembles (Krause. *et al.*, 2006). On the other hand, the coherence of the beam will be exploited to study the structure of objects on the nanometre scale by coherent X-ray diffraction imaging (CXDI). The potential of using a coherent source of X-rays in diffraction experiments has recently been realised in several experiments carried out on ID01 (Schropp *et al.*, 2006; Chamard *et al.*, 2006). This novel technique uses over-sampling for phase retrieval to reconstruct the investigated objects in real space, without using an elaborate model of the structure. Both spatially resolved microdiffraction (μ -XRD) and CXDI from low-dimensional systems will play an important role in the understanding of the structure, fabrication and functionality of many nanomaterials (see for example Krause *et al.*, 2006).

The advancement of CXDI will have wide ranging applications including the investigation of self-assembled semiconductor nanostructures, surfaces and interfaces, extended defects, granular materials and many other systems. In general, CXDI can be anticipated as a versatile tool to determine the full 3D spatial arrangement of scattering objects beyond crystalline unit cells.

Techniques

Microdiffraction on Nanostructures

XRD has proven to be a powerful tool for the determination of composition and strain distribution in nanostructures. Several methods have been established, based on measuring the diffuse intensity distribution with a high resolution in reciprocal space (Stangl *et al.*, 2004; Kegel *et al.*, 2001; Schüllli *et al.*, 2003; Malachias *et al.*, 2005; Metzger *et al.*, 2005; Malachias *et al.*, 2003). Whilst conventional local probe techniques such as transmission electron microscopy (TEM) typically reach lattice parameter resolutions of about $\delta a/a = 10^{-2}$, XRD experiments easily reach values of $\delta a/a = 10^{-3}$ to 10^{-4} . So far, large ensembles of typically 10^5 to 10^6 nanostructures have been investigated by XRD, providing statistically well averaged properties with a spatial resolution in the nanometre range for the average object under investigation. These XRD techniques consequently only yield meaningful results for ensembles with low dispersion in their nanostructure properties. However, the interest in studying single, individual nanostructures is increasing.

Considering their typical dimensions, an area with an extension of not more than about 100 nm has to be illuminated. In order to achieve detectable scattered intensities, focusing of the incident beam is required to concentrate the X-ray flux onto a very small area. Considerable progress has been made in recent years with X-ray focusing devices, and several groups have demonstrated focus sizes around or even below 100 nm (Schroer and Lengeler, 2005; David *et al.*, 2002; Di Fonzo *et al.*, 2000; Pfeiffer *et al.*, 2001). We therefore propose to exploit such focused "nanobeams" and use them for the analysis of individual nanostructures (Krause *et al.*, 2006). The same specific nanostructure can then be investigated with several techniques, *i.e.* μ -XRD, μ -EXAFS, μ -DAFS, μ -photo-luminescence, ... or using microscopy methods.

Coherent X-ray Diffraction Imaging (CXDI)

In order to obtain the real space structure from XRD experiments, structural models have to be assumed. The use of the coherence of third-generation synchrotrons offers a different approach, which allows a model free reconstruction directly from reciprocal to real space. If a nanostructure is illuminated by an X-ray beam with a transverse

coherence length at least of the same size as the nanostructure, coherent diffraction fringes appear, which can be over sampled and used to reconstruct a model free real space image of the nanostructure. The technique of coherent diffraction imaging has been applied in the forward direction to determine the 3D morphology of objects. In case of coherent diffraction close to Bragg reflections, additional information is obtained on strain and extended defects. CXDI has so far mainly been applied to metallic (sub)micron-sized crystals, which are almost strain free (Williams *et al.*, 2003). We propose to further develop CXDI on single islands of semiconductors coherently grown on a substrate (such as SiGe dots on Si). The main goal is to be able to determine, model free, the anisotropic strain distribution in a single island and the substrate.

X-ray Photon Correlation Spectroscopy (XPCS)

With the nanobeam setup, not only will the techniques mentioned above become feasible but other applications will also benefit. One example is X-ray photon correlation spectroscopy (XPCS) which requires a coherent beam. XPCS allows the study of dynamics as the speckle pattern is related to the exact positions of the scatterers relative to each other. So far, it has been used principally to study bulk systems, for instance order-disorder phase transitions (Fluerasu *et al.*, 2005) and the surface structure of liquids (Gutt *et al.*, 2003). We intend to study the nanostructure formation and dynamics during ion-beam erosion of surfaces as function of time, substrate temperature and ion energy. The combination of XPCS with grazing incidence techniques (GISAXS and GID) will reveal the dynamics of nanostructure formation from the morphological density fluctuations to the crystalline core, respectively.

Context with new sources and user community

Beamlines for the use of microfocus and/or coherence are planned or are in construction at DIAMOND (I. Robinson), PETRA-III (O. Leupold), the Swiss Light Source (F. Pfeiffer), SOLEIL (S. Ravy) and ALBA (M. Capitane).

DIAMOND: The techniques that will be used at the Coherent X-ray Diffraction and XPCS Beamline at the DIAMOND are similar to those of the ID01 project. On ID01, CDI in the forward direction can be performed with much higher resolution, due to the long SAXS channel. Beamline ID01 will be optimised for semiconductor nanostructures, whilst at DIAMOND the scientific areas will cover also soft condensed matter issues.

PETRA-III: Due to the outstanding brilliance of the storage ring, conditions for coherence based

techniques will be superior to any existing source. A beamline is planned for applications of coherent synchrotron radiation for studying both the static and dynamic properties of matter, applying coherent imaging techniques and XPCS. In spring 2009 the commissioning phase for the first beamlines will start. First user operation is foreseen for late summer 2009.

SWISS LIGHT SOURCE: The scientific case of the cSAXS beamline is focused on conventional small angle X-ray scattering, lensless imaging/coherent diffractive imaging, and XPCS. It is thus a perfectly complementary instrument to our setup, because at ID01 the diffractometer allows also for CDI at wide angles. The schedule of cSAXS will be ahead of the ID01 project with the start of commissioning being 1 February 2007 and the start of user operation 1 August 2007.

SOLEIL: CRISTAL is planned as a versatile instrument for diffraction on nanostructures, phase transitions in low dimensional systems, dynamics (*e.g.* XPCS) and time-resolved studies. The instrument is not dedicated to either the use of coherence or nanofocusing.

ALBA: Proposal WS04 describes a diffraction beamline for nanostructures, thin films and surfaces and interfaces very similar to ID01, but not focused on the use of coherence and microfocusing. The proposal was submitted to the ALBA SAC in February 2005. The timescale for its realisation is in the order of five years.

USER SUPPORT: Several user groups have given us written support for the project, since it offers new opportunities for science on a nanometre scale, like CDI on nanocrystals at Bragg peaks and nonperiodic (buried) objects in the forwards direction, the use of one dimensional waveguides for imaging and for spatially resolved strain investigations on device related structures.

List of interested users:

- Coherent small angle diffraction (lenseless imaging) on artificial objects (C. Schroer, Desy)
- Nanofocusing with refractive (planar) lenses (C. Schroer, Desy)
- Characterisation of the beam coherence and wave front analysis by state-of-the-art interferometry (C. David, PSI and ID01)
- Development of highly coherent divergent X-ray waves based on 2D wave guides for nano imaging:
 - Lithographically fabricated wave guides (T. Salditt, University Goettingen).
 - Waveguides based on rolled up nanotubes (O. Schmid, MPI Stuttgart)
- Structure-function relations of organic thin film transistors (TFTs) (B. Nickel, LMU Munich).
- Spatially resolved μ -XRD and CXDI on fibres under

in situ tensile stress (J. Keckes, Uni Leoben).

- Dynamics of critical fluctuations in crystalline materials (Fe_3Al) using incoherent microbeams.
- Studies in confined geometries (C. Mocuta, ID01, H. Reichert, MPI Stuttgart).

Technical considerations

So far, most experiments with X-ray nanobeams are performed for imaging or small angle scattering purposes, where the focusing element can be placed very close to the sample and often the experiments are carried out in transmission mode. The main complications in these experiments are the conditioning of the beam and the detector resolution.

For μ -XRD experiments on single crystal semiconductor samples, rotations around several axes over wide angular ranges are required, whilst keeping a specific nanostructure at the X-ray focus. The samples are typically several millimetres wide (*e.g.* when a whole chip is investigated or for future "*in vivo*" experiments on devices), restricting the minimum distance between focusing element and sample to several centimetres. With these restrictions a smallest theoretical focus size results of about 150 nm horizontally and 50 nm vertically.

In preliminary experiments, two main obstacles have been identified that need to be overcome in order to actually reach this sub- μm focus size: (i) instabilities of the monochromator lead to a virtual source size larger than the actual source size by a factor of two and six in the horizontal and vertical directions, respectively. This currently limits the achievable focus size to about 4 μm for a 1 m focal distance (expected value $\sim 1 \mu\text{m}$). Furthermore, the sagittal focusing of the second monochromator crystal reduces the lateral coherence lengths by the same factor of six, limiting the coherent diffraction imaging capabilities; (ii) vibrations of the whole diffractometer setup ($\sim 1.5 \mu\text{m}$ amplitude) inside the big vacuum vessel, adding to the apparent focus size; (iii) so far the sample and the last focusing element have had to be mounted on two separate bases, giving rise to vibrations between them with a magnitude of about 1 to 2 μm , which additionally "smears out" the X-ray spot on the sample. Hence for a sub-micron diffraction experiment, the existing focusing schemes have to be optimised, allowing for the required degrees of freedom, whilst maintaining a sufficiently small footprint.

We will therefore install a new nanobeam setup at ID01. In order to solve the first obstacle, a new monochromator is needed to improve the beam stability and to permit a low divergence beam to reach large transverse coherence lengths and for sub-micron focusing. Secondly, a new setup in the

experimental hutch is proposed, where the focusing optics and a high precision micro-diffractometer are placed on the same vibration-damped support to minimise vibrations. A 2D detector will be decoupled from this setup and positioned by a heavy-duty robot arm on a separate support.

The new setup will fit into the current experimental hutch without the need to remove existing setups, *i.e.* the "old" diffractometer in the big vessel. In particular, the versatile and highly flexible setup for small and wide angle scattering experiments will be kept in combination with anomalous scattering. The small angle X-ray scattering (SAXS) option at ID01 can be further used for CXDI in the forwards direction with detector-to-sample distance up to 7 m. The new monochromator is sufficiently compact to be placed in the optics hutch without interfering with the existing monochromator, so that both setups can be used alternatively.

For μ -XRD and CXDI, 2D detectors are needed with a high spatial resolution, single photon counting ability and large dynamic range. To this end, direct illumination CCDs are available. Currently, the CCD chips are restricted to an area of about 25 x 25 mm² and 20 μ m pixel size and a dynamic range of 16 bits. Larger, more efficient and faster CCD based or pixel detectors will become available soon.

Once a small beam footprint is achieved, it is important which particular area on the sample is illuminated. Whilst for many imaging applications it is not very important which particular area of the sample is under investigation, for device structures it is crucial to illuminate, for example, the strained silicon of a transistor channel, but not the source region. This requires a sample stage with fine sample translations and the means to detect the position on the sample.

If the structures are in the nanometre range, pre-alignment with an optical microscope is not possible and only larger alignment marks can be used. Within the *X-Tip FP6* project (coordinated by the ESRF), X-ray spectroscopy is combined with local probe analysis. In collaboration with the project partners, a new setup is being developed with an atomic force microscope (AFM) coupled to the diffractometer. With the AFM tip in the microfocus beam, the sample surface can be imaged and the nanostructure positions be determined. Hence any particular spot of the sample can be translated into the beam and investigated by μ -XRD/CDXI. This allows XRD to be performed on one specific nanostructure.

Support facilities

To carry out the project technical support (engineering, infrastructure, cabling, computing, electronic etc.) from the ESRF will be needed.

References

- Chamard V., Dolle M., Baldinozzi G., Livet F., de Boissieu M., Bley F., Donnadiou P., Metzger T.H., Mocuta C., Picca F., Labat S., and Thomas O. (2006), Distribution of local strain and density in a nanocrystal reconstructed from coherent x-ray diffraction with a focused beam, *Phys. Rev. Lett.* Submitted.
- David C., Nöhammer B., and Ziegler E. (2001), Wavelength tunable diffractive transmission lens for hard x-rays, *Appl. Phys. Lett.*, **79**, 1088.
- Di Fonzo S., Jark W., Lagomarsino S., Giannini C., De Caro L., Cedola A., and Müller M. (2000), Non-destructive determination of local strain with 100-nanometre spatial resolution, *Nature*, **403**, 638-640.
- Fluerasu A., Sutton M., and Dufresne E.M. (2005), X-Ray Intensity Fluctuation Spectroscopy Studies on Phase-Ordering Systems, *Phys. Rev. Lett.*, **94**, 055501.
- Gutt C., Ghaderi T., Chamard V., Madsen A., Seydel T., Tolan M., Sprung M., Grübel G., and Sinha S.K. (2003), Observation of Heterodyne Mixing in Surface X-Ray Photon Correlation Spectroscopy Experiments, *Phys. Rev. Lett.*, **91**, 076104.
- Kegel I., Metzger T.H., Lorke A., Peisl J., Stang J., Bauer G., Nordlund K., Schoenfeld W.V., and Petroff P.M. (2001), Determination of strain fields and composition of self-organized quantum dots using x-ray diffraction, *Phys. Rev. B*, **63**, 035318.
- Krause B., Mocuta C., Metzger T.H., Deneke Ch., and Schmidt O.G. (2006), Local Structure of a Rolled-Up Single Crystal: An X-Ray Microdiffraction Study of Individual Semiconductor Nanotubes, *Phys. Rev. Lett.*, **96**, 165502.
- Malachias A., Schüllli T.U., Medeiros-Ribeiro G., Cançado L.G., Stoffel M., Schmidt O.G., Metzger T.H., and Magalhães-Paniago R. (2005), X-ray study of atomic ordering in self-assembled Ge islands grown on Si(001), *Phys. Rev. B*, **72** 165315.
- Malachias A., Kycia S., Medeiros-Ribeiro G., Magalhães-Paniago R., Kamins T.I., and Stanley W.R. (2003), 3D Composition of Epitaxial Nanocrystals by Anomalous X-Ray Diffraction: Observation of a Si-Rich Core in Ge Domes on Si(100), *Phys. Rev. Lett.*, **91**, 176101.
- Metzger T.H., Schüllli T., and Schmidbauer M. (2005), X-ray methods for strain and composition analysis in self organized semiconductor nanostructures, *C. R. Physique*, **6**, 47-59
- Pfeiffer F, David C., Burghammer M., Riekel C., and Salditt T. (2002), Two Dimensional X-ray Waveguides and Point Sources, *Science*, **297**, 230-234.
- Schroer C.G. and Lengeler B. (2005), Focusing Hard X Rays to Nanometer Dimensions by Adiabatically Focusing Lenses, *Phys. Rev. Lett.*, **94**, 054802.
- Schropp A., Vartanyants I., Schroer C.G., Weckert E., Mocuta C., Metzger T., and Kurapova O. (2006), Coherent

X-ray Diffraction Imaging Experiment on ID01 at ESRF. *Proc. 8th Int. Conf. X-ray Microscopy. IPAP Conf. Series, 7, 383-385.*

- Schüllli T.U., Stangl J., Zhong Z., Lechner R.T., Sztucki M., Metzger T.H., and Bauer G. (2003), Direct Determination of Strain and Composition Profiles in SiGe Islands by Anomalous X-Ray Diffraction at High Momentum Transfer. *Phys. Rev. Lett.*, **90**, 066105.
- Stangl J., Holý V., and Bauer G. (2004), Structural properties of self-organized semiconductor nanostructures, *Rev. Mod. Phys.*, **76**, 725-783.
- Williams G.J., Pfeifer M.A., Vartanyants I.A., and Robinson I.K. (2003), Three-Dimensional Imaging of Microstructure in Au Nanocrystals, *Phys. Rev. Lett.*, **90**, 175501.

HXPM: Hard X-ray Photoelectron Microscopy

Summary

We propose to implement a new long (150 m) X-ray photo-electron spectroscopy nanoprobe beamline at the ESRF. The beamline will work in the X-ray range (≥ 1 to 25 keV) and be optimised for investigating, by electron spectroscopy, the chemical and electronic properties of bulk, interfaces, buried objects, nanocrystals and gas exposed surfaces and nano catalysts. Photoelectrons up to 15 keV will be detected with down to 10 meV resolution.

Microscopy can be performed by scanning the sample with nanometre accuracy. Photoelectron imaging can be combined with the X-ray standing wave (XSW) technique to simultaneously obtain spatial resolution on the atomic scale. Spin detection could be a further option. For efficient use of beamtime and complementary structural information, a diffractometer will be installed in the first experimental hutch.

Scientific case

Overview

This is a proposal for an X-ray photoelectron spectroscopy nanoprobe beamline. In order to achieve sub-micrometre special resolution the beamline must be long, with the sample position at least 150 m from the source. The beamline will operate in the tender and moderately hard X-ray range (≥ 1 to 25 keV). The photoelectron spectrometers will allow electrons up to 15 keV kinetic energy to be analysed down to 10 meV resolution. The instrument will be optimised for investigating, by electron spectroscopy, the chemical and electronic properties of the bulk of small objects,

interfaces, buried objects, and gas exposed surface, with lateral dimensions down to the 50 nm range (and below) and with depth information greater than 20 nm. Microscopy can be performed by scanning the sample with nanometre resolution. Photoelectron imaging would be a further option and in this case microscopy can also be utilised in conjunction with the X-ray standing wave (XSW) technique to gain atomic resolution. Investigation of magnetism via spin detection would be a further option. The HXPM instrument is complementary to nano-XAFS and nanofluorescence, since XPS allows access to light elements (C, N, O, etc.), important for soft condensed matter and environmental science, and has chemical specificity with (very) high resolution. The beamline needs an optics concept that allows the energy resolution to be matched as is necessary for the experiment from several eV down to about 10 meV (above about 6 keV) with close to 100% throughput at any resolution. Similarly the focal spot size should be adjustable to the problem under study from millimetres down to 50 nm (and below, depending on the available length for the beamline).

The first area of application is material science:

The instrument will be able to perform scanning electron spectroscopy for chemical analysis (ESCA) with better than 50 nm spatial and 100 meV to few eV electron energy resolution for analysis of the local chemical composition (nano-ESCA). This is relevant for micro-/nano-electronic devices, grains and grain boundaries, clusters, dots, and domains in thin films, buried interfaces and more.

The second area of application is physical science/solid state physics:

Valence band and conduction band spectroscopy with about 20 meV to 500 meV energy resolution can be performed to determine local electronic properties of (compound) materials, devices, grains, grain boundaries, interfaces, nanodots, and exotic (small) crystals with spatial resolution down to 50 nm from near surface areas down to depths exceeding 20 nm.

The third area of application is catalysis and sensor technology:

Using hard X-rays, the chemical (and electronic) specification of gas/solid interface reactions during gas exposure is possible, thereby obtaining information on typical nanosized metal catalysts. The high electron kinetic energy and small sample size would permit, in conjunction with suitable differential pumping, the investigation of catalytic processes at gas pressures up to (and even above) 10 mbar.

Techniques

First technique in second experimental hutch

In the second experimental hutch will be a UHV chamber with a photoelectron spectrometer for hard

X-ray photoelectron spectroscopy (HAXPES) allowing electrons to be analysed with kinetic energies up to 15 keV and with an energy resolution down to 10 meV. The sample will be in UHV on a three circle manipulator with a high resolution x-y scanning stage (nm resolution). The electron lens of the HAXPES instrument will have a focal spot size of about 20 to 50 μm . The last vertically (horizontally) focusing element is foreseen to be at a distance of about 100 mm (50 mm) in front of the sample. With an effective source size of 20 μm (150 μm , for a high beta section achieved by a front end aperture) this would permit a vertical (horizontal) focus of about 20 nm (50 nm). In the selected spot fast data acquisition with high energy resolution is possible, but area mapping is time consuming.

Second technique in second experimental hutch

Another UHV chamber with a photoelectron spectrometer for hard X-ray photoelectron spectroscopy (HAXPES) will be in the second hutch and allow the analysis of electrons with kinetic energies up to 15 keV and with an energy resolution down to 10 meV. Appropriate differential pumping stages allow the studied sample to be in up to a 10 mbar gas atmosphere. The X-ray beam will enter this chamber through a thin window. Sample manipulator and optics will be similar to as described above, however, with compromised resolution because of the high pressure high temperature requirements.

Third technique in the third experimental hutch

A HAXPES PEEM instrument would allow a combination of HAXPES microscopy with the X-ray standing wave (XSW) technique. The spatial resolution is in this case achieved not with the X-ray beam, but with the electron optics. A HAXPES PEEM (without XSW option) is presently commissioned at SPRING-8. In combination with the XSW technique, structural studies with atomic resolution and chemical specificity can than be performed on a (few) nanometres scale. The advantage is in obtaining the field of view in one shot with high spatial resolution, but locally the signal is low, thus resulting in long counting times and a very moderate energy resolution.

Fourth technique in the first experimental hutch

High resolution X-ray diffraction is proposed to be performed in the first experimental hutch. A state-of-the-art six circle diffractometer will be installed for surface/interface studies in the first experimental hutch as it is presently the case at ID32. UHV equipment frequently needs service and bake-out periods and, in order to utilise the synchrotron X-ray beam efficiently, a non-UHV instrument positioned upstream could efficiently use the beam to avoid the beamline being unnecessarily idle. GIXRD is a useful complement to HAXPES and XSW for studying interfaces and thin films.

Context with new sources and user community

The ESRF will remain the most brilliant European synchrotron in the hard X-ray regime (with the possible exception of PETRA-III). A HAXPES station at PETRA-III is in the planning stage but there are no plans for a nano focusing HAXPES microscope. Soft X-ray PEEM instruments with sub-micrometre resolution are available at other facilities (ELETTRA, BESSY-II, ALS, etc.) but they lack the necessary information depth and the energy resolution, that can be achieved with the proposed HXPM instrument. This is extremely interesting for the micro-/nano-electronics industry, with device dimensions reaching the 20 nm size within a few years. The present XPS facilities at ID32 are already experiencing a strong increase in interest from the semiconductor industry (ST, LETI, Philips, Freescale). Other customers will come from the materials science community and from chemistry industry and departments, since the HAXPES technique is complementary and partially superior to other chemical specification techniques such as absorption spectroscopy and X-ray fluorescence spectroscopy, due to access to low-Z elements and higher energy resolution. Finally, environmental scientists and, last but not least, solid state and surface physicists will be attracted by the instruments proposed.

Technical considerations

A windowless beamline will be needed to cover the energy range from about 1.5 to 30 keV, with the peak performance around 15 keV. The optical design of the beamline has to allow for a high degree of flexibility. It should provide:

- Tunability of the photon energy from 1.5 to 30 keV;
- High beam stability;
- Flexible bandpass (several eV down to 10 meV);
- Maximum throughput for a given bandpass;
- Variable focal spot sizes down to < 50 nm.

The first optical element at a source distance of about 30 m will be a set of compound refractive lenses (CRLs) with rather long focal distances acting as collimators. CRLs can be manufactured accepting the full horizontal beam size (about 1.5 mm) from a high beta undulator source (at 30 m). The CRLs will only work efficiently down to about 5 keV. Mirror focusing might be an option (for low energies), if stability issues for the about 150 m long beamline can be solved.

The second optical element at a distance of about 15 m from the first experimental station will be (a) a high heat load, fixed offset multilayer monochromator and (b) a high heat load, fixed offset,

high stability Si(111) double crystal monochromator. The monochromators are placed relatively close to the experiment to minimise stability problems. Otherwise it would be preferable to place the monochromators closer to the source to shorten the white beam path.

The third optical element is a two axis, high resolution post-monochromator, which allows a variable bandpass down to 10 meV to be selected with maximum throughput (similar to the one which exists at ID32).

The fourth optical element is again a set of CRLs at a distance of about 6 m from the first instrument (the six circle diffractometer) providing a minimum spot size of about $20 \times 2 \mu\text{m}^2$ on the diffractometer.

The last optical elements are zone plates (ZPs) and/or CRLs at short focal distance right before the HXPM and the high pressure HXPS.

Support facilities

An off-line characterisation laboratory with XPS would be useful. A laboratory with "standard" surface analysis tools (STM, LEED, AES, ...) and deposition facilities (MBE, PLD, sputtering, ...) would be needed. Similar to the demand by other nanofocusing projects, nanocharacterisation facilities with complementary instruments (electron, STM/AFM, infrared, confocal microscopes, nanomanipulation, deposition systems, etc.) are needed.

References

- Dallera C., Braicovich L., Du L., Paolicelli G., Cowie B.C.C., and Zegenhagen J. (2005), Hard X-ray Photoelectron Spectroscopy: Sensitivity to Depth, Chemistry and Orbital Character, *Nuc. Instr. Meth. A*, **547**, 113-123.
- Dallera C., Panaccione G., Paolicelli G., Cowie B., Zegenhagen J., and Braicovich L. (2004), Looking 100 Å Deep into Spatially Inhomogeneous Dilute Systems with Hard X-ray Photoemission, *Appl. Phys. Lett.*, **85**, 4532-4534.
- Kunz C., Thiess S., Cowie B.C.C., Lee T.-L., and Zegenhagen J. (2005), Outer Sub-Shell Cross-Sections Determined by X-ray Photoelectron Spectroscopy up to 14.5 keV, *Nuc. Instr. Meth. A*, **547**, 73-86.
- Martinez E., Clavelier L., Renault O., Le Royer C., Cosnier V., Hartmann J.-M., Zegenhagen J., Lee T.-L., Campidelli Y., and Loup V. (2007), Interface Chemical Characterization of Novel W/HfO₂/Ge Stacks, *ICM106 proceedings, J. Vac. Sci. Technol.*, **25**, 86-90.
- Yasufuku H., Yoshikawa H., Kimura M., Vlaicu A.M., Kato M., Kudo M., Fujikata J., and Fukushima S. (2006), On the wide-energy-range tuning of x-ray photoemission electron microscope optics for the observation of the photoelectrons excited by several keV x-rays, *Rev. Sci. Instr.*, **77**, 033702.

SURF: Surface Diffraction

Summary

The characterisation of the structure terminating a solid is fundamental for the understanding of surface and interface properties. The recent upgrade of the surface diffraction beamline of the ESRF has been carried out with this aim in mind and will further evolve in order to provide the user community with a state of the art beamline allowing several experimental techniques. The main technical objectives of the beamline can be summarised as:

- to provide a high intensity, stable and energy tuneable X-ray beam with micrometric dimension;
- to offer high quality instrumentation for *in situ* surface studies;
- to increase the diffractometer speed in order to study surface reactions with a finer time resolution;
- to implement new data collection methodologies giving the possibility of faster data acquisition;
- to adapt the ESRF instrumentation in order to integrate equipment from users.

The beamline exploits several surface sensitive techniques applicable to systems under ultra-high vacuum (UHV) conditions as well as to liquid-solid and solid-solid interfaces or to systems under "high" gas pressure (up to several bars) and high temperature.

Samples are studied *in situ* and, for this reason, the ESRF instrumentation must have sufficient flexibility to adapt to the needs of users. The first hutch is equipped with a versatile vertical axis diffractometer able to host user equipment of limited size and weight (up to 100 kg). The second hutch contains a large horizontal diffractometer hosting a UHV chamber. In the framework of the Upgrade Programme we will develop and improve the existing instrumentation providing the users with:

- A new experimental flow reactor dedicated to heterogeneous surface catalysis studies with a computer controlled gas line and an RGA system;
- An experimental chamber directly connected to the windowless beamline in order to perform GISAXS experiment avoiding background scatter from beryllium windows;
- An upgrade of the existing horizontal diffractometer to install micropositioning devices to carry out experiments on micrometric samples such as whiskers;
- An upgrade of the horizontal diffractometer to allow the installation of user experimental chambers.

The techniques available on the beamline will be surface diffraction, grazing incidence small angle scattering and coherent imaging and photon correlation spectroscopy.

Scientific case

The first surface X-ray diffraction (SXRD) experiments were carried out in the 1980s with the aim of solving the three dimensional termination structure of solids or determining the adsorption geometry of atoms deposited under UHV conditions. The technique has made enormous progress with the development of dedicated X-ray synchrotron sources and the concomitant increase in the available flux and improvements in beam collimation, allowing shorter acquisition times and larger signal to noise ratios. Further development on the instrumentation, together with advances in the data analysis, resulted in the possibility of solving complex systems with a large number of atoms in each unit cell.

The ID03 beamline optics have been updated recently, gaining in stability, energy tuning, focalisation and flux. The scientific fields covered by the beamline have grown over time and, for the medium and long term, we intend to further develop the existing instrumentation in order to cover the following scientific topics:

- **Surface crystallography** under UHV and moderate pressure conditions (for example high pressure, liquid-liquid environments). The characterisation of a crystallographic structure termination or the adsorption geometry of atoms and molecules is fundamental for the comprehension of the system properties. Surface X-ray crystallography is a unique tool making it possible to determine the structure of the buried interface non destructively, which is not achievable with other techniques. The complexity of the systems being studied is growing with time and it is now possible to determine the structures of ordered surfaces involving a large number of atoms, as demonstrated by the case of fullerene molecules on noble metal surfaces, where unique information on the adsorbate-surface bonds and on induced substrate deformation has been obtained (Felici *et al.*, 2005). In the future, this technique will be applied principally to determine the structure of complex molecules adsorbed onto surfaces and to highlight the role of the interaction between the substrate and the adsorbate in the formation of new systems. For this purpose a specialised chamber is required to handle organic compounds and to prepare the samples *in situ*.
- **Reactions at surfaces** occur at well defined thermodynamic conditions. Recent technical developments have made it possible to overcome the so called pressure gap, allowing surface X-ray diffraction to be used in understanding the role of the catalyst. Time dependent SXRD experiments under realistic operating conditions have shown the crucial active role of metal oxides in catalytic reactions, whereas the oxide was previously believed to be a pollutant and inhibitor of the reaction (Ackermann *et*

al., 2005). However, the explorable time-frame of the dynamics of the system is still limited by the large volume of the existing reactor and many phenomena occur on a timescale much shorter than presently accessible. To improve the experimental setup (in the frame of an existing collaboration with Leiden University), a new chamber will be designed with a much smaller volume, thus offering the possibility of fast computer controlled gas exchange together with a residual gas analyser connected to the acquisition electronics. A second class of experiment will concern looking at surface morphology depends upon the surrounding atmosphere. These studies will be carried out on nanoparticles by GISAXS to look at evolution in shape and on metal whiskers for performing surface crystallography.

The study of time dependant phenomena at surfaces is a new class of experiments crucial to measure *e.g.* the evolution of surface structure during growth. For this purpose new data acquisition methodologies will be developed based on the use of area detectors, in order to optimise data acquisition and intensity integration (Schlepütz *et al.*, 2005). This approach is effective when it is possible to improve the signal to noise ratio in order to gain time resolution. A new class of experiments will then be possible such as the study of phase transition between two surface phases, characterisation of the friction between two solids (Rubinstein *et al.*, 2004), initial stages of corrosion (Renner *et al.*, 2006) and the evolution of surface nanostructures Molle *et al.*, 2005).

The beamline is equipped with two experimental hutches arranged in-line. The incident beam energy ranges between 5 to 30 keV. The beamline must be windowless to limit the background and to preserve the coherence of the beam. The typical beam focus size depends on the experiment and ranges from about 20 microns with a flux of at least 10^{13} ph/s/100mA in the case of diffraction experiments, when the diffractometer sphere of confusion is the limiting factor, to 1 micron or less in the case of nanoimaging at surfaces (Robinson *et al.*, 2001). Both hutches will be equipped with high precision (micron) diffractometers: the upstream one in a vertical geometry and the downstream one with a main horizontal axis to be coupled with UHV systems. Both hutches will be equipped with 2D detectors for GISAXS experiments. Since the speciality of the beamline is the *in situ* preparation and characterisation of the systems under study, both experimental apparatus must be able to accept user chambers.

Context with new sources and user community

Almost every X-ray synchrotron source has at least one beamline dedicated to surface studies and the

new European synchrotrons also plan to build such facilities *e.g.*:

- DIAMOND: beamline I07 dedicated to surface studies is planned for 2009. The beamline consist of two experimental stations, one for UHV studies and one for liquid surfaces.
- SOLEIL: beamline SIXS will be dedicated to surfaces and interfaces. The beamline will consist of two experimental stations.
- ALBA: A beamline mainly conceived for surface magnetism is under consideration.
- ANKA: A beamline for surface diffraction is under construction.

Similarly to the ESRF, these beamlines will allow the possibility of interchangeable equipment. They will offer a comparable flux for beam energies up to only 10 keV, meaning that ESRF has a unique capability at higher energies, giving the possibility of improved studies of buried interfaces and access to a wider region of space (more resolution in the direct space).

Till now, surface diffraction has been a technique used by physicist or material scientists. However, by extending the applicability of the techniques closer to "real" conditions new classes of scientists such as organic chemists and geologists will be able to gain from the improvements to the ESRF surface science beamline.

Technical considerations

The present surface diffraction beamline optics is based on a liquid nitrogen cooled monolithic channel cut monochromator and on a cylindrical mirror on a bender assuring beam focus in both experimental hutches. This optics design will be maintained because it has shown remarkable performances in terms of beam stability, energy tuning, focusing and heat load dissipation. This optics design can be coupled with other focusing optics placed just before the sample to provide a submicron X-ray beam coupled with a very high flux.

The evolved beamline does not need to be longer than 77 m, *i.e.* the limit of the present experimental hall. It needs, however, the full beam power of a full straight section. For the future, the use of revolving undulators is highly recommended. The size of the experimental hutches, however, should be increased. This will allow some present limitations for the installation of user instrumentation to be overcome. Finally, in order to prevent the source coherence and to limit the background, the beamline must be windowless.

References

- Ackermann M.D., Pedersen T.M., Hendriksen B.L.M., Robach O., Bobaru S.C., Popa I., Quiros C., Kim H., Hammer B., Ferrer S., and Frenken J.W.M. (2005), Structure of surface oxides on Pt(110) during catalytic CO oxidation, *Phys. Rev. Lett.*, **95**, 255505-1.
- Felici R., Pedio M., Borgatti F., Iannotta S., Capozzi M., Ciullo G., and Stierle A. (2005), X-ray-diffraction characterization of Pt(111) surface nanopatterning induced by C60 adsorption, *Nature Materials*, **4**, 688-692.
- Molle A., Buatier de Mongeot F., Boragno C., Moroni R., Granone F., Sekiba D., Buzio R., Valbusa U., Felici R., and Quirós C. (2005), Dense arrays of Co nanocrystals epitaxially grown on ion-patterned Cu(110) substrates, *Appl. Phys. Lett.*, **86**, 141906-1.
- Renner F.U., Stierle A., Dosch H., Kolb D.M., Lee T.-L., and Zegenhagen J. (2006), Initial corrosion observed on the atomic scale, *Nature*, **439**, 707-710.
- Robinson I.K., Vartanyants I.A., Williams G.J., Pfeifer M.A., and Pitney J.A. (2001), Reconstruction of the shapes of gold nanocrystals using coherent x-ray diffraction, *Phys. Rev. Lett.*, **87**, 195505.
- Rubinstein S.M., Cohen G., and Fineberg J. (2004), Detachment fronts and the onset of dynamic friction, *Nature*, **430**, 1005-1009.
- Schlepütz C.M., Herger R., Willmott P.R., Patterson B.D., Bunk O., Brönnimann Ch., Henrich B., Hülsena G., and Eikenberry E.F. (2005), Improved data acquisition in grazing-incidence x-ray scattering experiments using a pixel detector, *Acta Cryst.*, **A61**, 418-425.

Introduction to the Conceptual Design Reports of the Technical Beamline Support Group

The Upgrade Programme of the ESRF relies on the development of instrumentation, expert technical support and an adapted infrastructure in order to provide state-of-the-art experimental setups that will open up possibilities for a new class of experiments.

The optical elements, detectors, beam conditioners and sample environments necessary to carry out the Upgrade projects will require the integration of hierarchically nested intelligent components rather than the traditional method of lining up discrete, independent components.

On the nanofocusing beamlines of the future, the sample will no longer be a static object. Instead, it will be a highly dynamic element at the centre of a complex hierarchy of devices. This will imply the integration of tools for visualising, handling and characterising samples that are invisible to the optical microscope. Remote manipulation will be mandatory to guarantee the reliability of the setups, the safety of the installations and the consistency of the operations. It will also be mandatory to actively position the beam onto the sample region of interest under study and to integrate other characterisation tools that complement the X-ray analysis. The optical elements, detectors, sample positioning devices and sample environment will use some of the most advanced technologies available including embarked metrology and embedded software.

The multidisciplinary approach to science and the integration of diverse technologies around the same sample environment means that developing, integrating and testing instrumentation is an effort that will go beyond the capabilities of the ESRF. The instrumentation will therefore need to be envisaged within a larger collaborative scheme. Whilst it is desirable to maintain flexibility in instrumentation, it is also essential to converge towards a standard way of using facilities. For the synchrotron radiation instrumentation of the future a coordination effort

amongst European facilities and an infrastructures network for the support of development activities are both necessary.

As a contribution to this infrastructures network the ESRF proposes two facilities for testing, assessing and improving instrumentation: a white beam station (**WIBIDI**) for assessing all the variety of white beam instrumentation (silicon, diamond and multilayer monochromators, beam position monitors, slits and attenuators, radiation endurance of components, cooling and thermal stability issues, etc.) and another one with monochromatic beam (**TIBIDI**) for testing instrumentation in its real conditions.

Since a large part of future science will see the integration of a variety of techniques on the same physical sample, these test beamlines should also serve as test benches for this multimodal approach. The beamlines should be open on a competitive basis to challenging and risky projects that would not receive time allocation through standard proposal paths.

Last but not least, these test beamlines should be used for training a new generation of engineers and scientists who, because of the high specialisation of the beamlines of today, risk being more and more removed from real hands-on experience in instrumentation.

The project **OPTICS** is of different nature: the difficulties of finding commercially good aspherical substrates as a basis for advanced optics prompted the idea of using the know-how accumulated at the ESRF over the last few years for profiling substrates by ion beam figuring and selective deposition under *in situ* X-ray interferometry. The project cannot be hosted on an undulator beamline, because it needs the stability and the angular opening of a bending magnet. Nevertheless, as a manufacturing plant, it could be damaging to other activities on a bending magnet beamline.

Summary of individual CDRs

| | | |
|---------------|--|---------|
| OPTICS | Facility for Surfacing Mirror Substrates: <i>In situ</i> and real time ion beam surfacing, thin film growth and temperature annealing in mirror/multilayer structures. | page 78 |
| TIBIDI | Technical Beamline for Instrumentation Development: A test bench where the innovative instrumentation required for new science may be tested, improved and assessed. | page 79 |
| WIBIDI | White Beam Technical Development Beamline: A white beam test beamline as an inherent part of the ESRF instrumentation development infrastructure open to European developers. | page 81 |

OPTICS: Facility for Surfacing Mirror Substrates

Summary

The ESRF has operated a bending magnet beamline (BM05) for over ten years that has served as a test bed for new X-ray characterisation methods and instrumentation, and particularly for the development and testing of X-ray optical elements. For these purposes the lower flux of an ESRF bending magnet source as compared to the one delivered by an insertion device is compensated by a greater stability, which is a key parameter in (X-ray) metrology.

Meanwhile, the competitiveness present in both the fields of science and technology calls for an evolution of the role of synchrotron beamlines in the development of instrumentation including a greater specialisation. In this CDR, a project to be implemented on a bending magnet beamline is described, which makes use of the experience acquired on surface characterisation to help understand processes such as ion beam surfacing, thin film growth, and temperature annealing in multilayer structures. The originality of the approach will consist of performing these studies *in situ* and in real time, which implies the development of dedicated instruments.

Scientific case

Overview

Due to the complexity of any modern synthesis process, including ion beam surfacing and thin film growth, it becomes important to implement state-of-the-art characterisation methods including X-ray reflectometry, diffuse scattering and X-ray wavefront analysis directly onto the systems where surface processes are performed. Thus, the study of the dependence of any given property of interest (magnetic, optical, etc) on the surface or the interface topography of a sample can be made online. This integrated approach offers several advantages over the usual development approach consisting of preparing a series of samples under various conditions in a laboratory and of characterising their properties *a posteriori*. It eliminates side effects such as contamination and structural and chemical transformation of the materials that may build up with time, which create dispersion in the results. The *in situ* and real time characterisation provides useful insights on a process directly, instead of mapping the multi-parameter space that describes a process. More generally, the online approach offers a more efficient way of using the synchrotron light and of

synthesising new materials, thus speeding up the advent of new devices once the first observation of a new physical property has been reported.

One major activity proposed will consist of producing X-ray nanofocusing reflective optics, as many fields are expected to benefit from such extreme focusing conditions, including scanning and full field X-ray imaging and magnified phase imaging in particular. However, obtaining diffraction limited performance requires mirror surfaces with figure errors of not more than a few nanometres over length scales spanning from a few hundred micrometres up to the mirror length. To produce mirrors with the adequate stigmatic shape and surface quality, a mirror surfacing tool will be combined with an online metrology instrument. The surfacing method will be either an ion beam figuring process (Mercier *et al.*, 2001; Schindler *et al.*, 2003) or the differential deposition of a coating (Ice *et al.*, 2000). As these methods are non-contact techniques, it then becomes possible to integrate an online metrology method to control the mirror figure and finish levels during the machining process. With X-rays as the online metrology probe, the effects of all process parameters on the mirror performance can be studied by looking at the outgoing wavefront. The combination of an online, at-wavelength, monitoring of the mirror figure and finish with a surfacing tool is essential in realising a short feedback loop and to progressively reach the ultimate mirror performance.

Techniques

The experimental setup, installed at BM05, is presently unique in the world (Ziegler *et al.*, 2006). It combines an apparatus equipped with an ion-beam etching device, thin-film sputter sources and an online metrology tool based on real time measurements of the X-ray scattered beam for surface figure (Weitkamp *et al.*, 2005) and surface finish diagnostics (Pevevini *et al.*, 2005). The surface figure is obtained from the shape of the wavefront downstream of the sample as measured by an X-ray shearing interferometer. The finish level can be investigated by diffuse X-ray scattering measurements. For example, in the case of X-ray optical surfaces, sub-micrometre features on the surface would reduce the reflectivity of the mirror and degrade the image quality. Therefore, it is important to characterise the surface at these spatial scales. The passage from one technique to the other is made without modifying the environment and geometry at the sample level. With these two diagnostic methods mentioned above, the topography of the surface will be accessed within an extremely wide spatial frequency range, up to nine orders of magnitude (cm^{-1} to nm^{-1}).

Methods for measuring accurately an X-ray wavefront and to detect distortions well below the nanometre

regime are being developed. Preliminary measurements with the shearing interferometer indicate a slope error repeatability of at least 30 μ rad. Alternative methods, for example based on speckle interferometry, could also be developed.

In the case of magnetic films, Kerr effect measurements can be performed, for example to link magnetisation properties to surface roughness and conformity.

Context with new sources and user community

Since traditional polishing methods are not sufficient in reaching the specifications required for nanooptics, several approaches are being investigated throughout the world for manipulating the surface materials at or near the atomic level (final figuring): differential deposition technique at APS, elastic emission machining (EEM) at Osaka University (collaboration with SPRING-8), ion beam figuring at Zeiss. However, none of them have access to online at-wavelength characterisation as proposed here, which allows reduced risk for the optics and faster figuring. For example, it takes one month to produce a mirror with the present EEM method, an unattractive proposition for industry.

In this context, the proposed online mirror surfacing facility will allow the ESRF to play a key role in the manufacturing of nano reflective optics, hence securing the supply of elements that are crucial to the whole ESRF Upgrade Programme. This will open up the possibility of collaboration with the European synchrotron and FEL communities through the platform, and possibly attract industry (both mature and start-up) interested in new markets.

Technical considerations

In the long run the present experimental setup will need to be replaced by a system designed to accommodate the size of the mirrors required by the various partners. The adequate synchrotron light source is a bending magnet both for its beam stability and for the large beam width it delivers, thus avoiding any motion of the metrology tool (*e.g.* interferometer) during process and allowing a mirror sector size up to 100 mm to be measured in one go.

A robust iterative algorithm needs to be developed (collaboration with I. Kozhevnikov, Crystallography Institute, Russia) to realise a feedback loop between the wavefront information delivered online by the interferometer and the surfacing tool that guarantees performance and time effectiveness.

Speckle metrology and near-field scattering using X-rays are new fields and will need further development before they may be used effectively for X-ray beam diagnostics, directional stability monitoring and wavefront analysis.

References

- Ice G.E., Chung J.S., Tischler J.Z., Lunt A, and Assoufid L. (2000), Elliptical x-ray microprobe mirrors by differential deposition, *Rev. Sci. Instrum.*, **71** (7), 2635-2639.
- Mercier R., Mullot M., Lamare M., and Tissot G. (2001), Ion beam milling fabrication of a small off-axis ellipsoidal mirror, diffraction limited to 1 μ m resolution at 14 nm, *Rev. Sci. Instrum.*, **72**(2), 1559-1564.
- Peverini L., Ziegler E., Bigault T., and Kozhevnikov I.V. (2005), Roughness conformity during tungsten film growth: An *in situ* synchrotron x-ray scattering study, *Phys. Rev. B*, **72**(4), 045445.
- Schindler A., Haensel T., Nickel A., Thomas H.-J., Lammert H., and Siewert F. (2003), "Finishing procedure for high-performance synchrotron optics" in *Optical Manufacturing and Testing V*, edited by H. Philip Stahl. SPIE Conference Proceedings 5180, International Society for Optical Engineering, San Diego, CA, pp.64-72.
- Weitkamp T., Nöhammer B., Diaz A., David C., and Ziegler E. (2005), X-ray wavefront analysis and optics characterization with a grating interferometer, *Appl. Phys. Lett.*, **86**, 054101.
- Ziegler E., Peverini L., Kozhevnikov I., Weitkamp T., and David C. (2006), "On-line mirror surfacing monitored by X-ray shearing interferometry and X-ray Scattering", Ninth International Conference on Synchrotron Radiation Instrumentation, J.-Y. Choi, S. Rah, Eds, *AIP Proc.* vol. **879**, pp.778-81, Daegu, Korea.

TIBIDI: Technical Beamline for Instrumentation Development

Summary

In the framework of the ESRF Upgrade Programme, unprecedented characteristics in terms of stability and focal dimensions will be required for many beamlines, in addition to a large choice of sample environments and instrumentation for fast data acquisition and reduction. On the instrumentation side, this represents a real challenge for merging, integrating and validating a large variety of instrument scenarios. Indeed, the development areas of synchrotron radiation instrumentation for the future include optics, nanopositioning, automatic control, on-the-fly data acquisition and reduction, vibration damping and temperature control, extreme sample conditions, visible light spectroscopies and pump-and-probe, to name just a few. Advancements in these areas and

especially component integration cannot be made efficiently without a test bench, whereby the innovative instrumentation required for new science may be tested, improved and assessed.

Scientific case

Overview

The **TIBIDI** project is dedicated to the development and assessment of innovative instrumentation for synchrotron radiation and the testing of new methodologies in science with a special emphasis on multimodal research based on the combination of synchrotron light with other characterisation techniques. The project should be the basis of a wide collaborative effort with all interested facilities and research centres.

TIBIDI is intended for the test, assessment and improvement of the experimental setups resulting from the integration of various separate synchrotron radiation related technologies and engineering. Not only would the line be open instrumentation, but it would also aim to test new combinations of techniques aiming to optimise the scientific impact of synchrotron radiation. Important space should also be dedicated to the training of young scientists and engineers on the key present and future technologies for synchrotron radiation.

The proximity of large facilities for the production of nanoelectromechanical systems (NEMS) to the ESRF should encourage the integration of these devices in all the areas relevant to synchrotron radiation, from nanooptics to microfluidics, from microreactors to nanopositioning devices.

Technique 1: Test of integrated systems

The core of the beamline is constituted of modular instrumentation benches open to all European facilities for test and assessment purposes. The structure of the beamline will be flexible enough to host the variety of technologies that are at the basis of synchrotron radiation instrumentation.

A non-exhaustive list includes:

- Optical elements for beam conditioning: focusing, cleaning and shaping;
- Precision mechanics for optical elements;
- Recognition and navigation on samples below the micron scale;
- Parallel nanorobotics for nanomanipulation;
- A multimodal approach: parallel Local Probe Microscopy, MicroRaman, IR;
- Extreme sample environments in combination with the three points above;
- Beam position monitors and beam steerers;
- 2D detector development and test;

- Instrumentation integration;
- Fast data acquisition and online data reduction and compression.

High heat load instrumentation will be tested on a separate beamline.

Technique 2: Development of new experimental methodologies

Instrumental development constitutes a key element for the development of new science. Nevertheless, the development of new experimental methodologies, by integrating novel instrumentation or introducing new characterisation methods, is equally important. **TIBIDI** therefore entails a second hutch where both in-house and external users could check the feasibility, the limits and the possibilities offered by new methodologies that could not be tested in the frame of the beam time normally allocated to long term proposals. The architecture of the beamline will take in account its peculiar exploratory character and make possible the installation of user defined equipment for long periods of time.

An example of this could be the possibilities offered by the combination of high speed reciprocal space mapping with electron microscope holography and local probe manipulation or beam manipulation by of high speed NEMS arrays. This type of feasibility study require resources that go beyond the possibilities offered by a single facility, but the availability of the proper infrastructures should prompt an aggregation of resources that would be largely rewarding.

Another example is related to the ever expanding synchrotron user community: as more and more scientists adopt synchrotron radiation characterisation tools it will become increasingly important to offer easy access to operate beamlines and run experiments through user friendly software control. To this end, new software methodologies for user modifiable software and graphical user interfaces are to be developed in collaboration with novice users.

Training

An instrumentation culture cannot be maintained without a consistent programme of training. Instrumentation training for scientists and engineers is increasingly necessary since the configurations of standard beamlines are kept essentially frozen for optimising their throughput. To this end, the project **TIBIDI** wants to offer a high end "hands-on" training tool for young engineers and instrument scientists at European level. In time, **TIBIDI** could be the core of a Master training in synchrotron radiation instrumentation.

Context with new sources and user community

ESRF has acquired a leadership in some areas of synchrotron instrumentation development and testing. This advantage can be kept only by interpreting the needs of the new sources and proposing collaborative efforts for a European growth of instrumental culture.

Technical considerations

The project should be technically associated to beamlines likely to be affected by instrumental development, which could offer alternative facilities for extreme condition testing. (Very long optical arms, special sample environments, etc).

Support facilities

The area around the selected beamline should not be remote from the instrumentation and nanotechnology development areas. Ideally it should be at the heart of the instrumentation development group.

WIBIDI: White Beam Technical Development Beamline

Summary

The availability of white beams is essential to the development of new synchrotron radiation instrumentation. Future beamlines will need high precision and stable upstream devices for beam conditioning (for example: slits, attenuators, filters) and active devices (such as large bandpass monochromators) capable of preserving the beam characteristics in terms of emittance and coherency. These devices should also, at the same time, reduce the impact of the thermal load on downstream components. In a global approach to improve beamlines it is also essential to develop beam position monitors good enough to feedback information to the beam steering system of the storage ring.

WIBIDI is a white beam test beamline and an inherent part of the ESRF instrumentation development infrastructure open to all European developers in the field.

Overview

The development and test of high heat load components will receive increasing attention in the next generation of synchrotron radiation installations where

stability of the beams and coherency will be a prime asset. An optimal layout for the next generation beamlines will envisage a first optical element capable of transferring downstream beams characterised by high geometrical stability and minimum power. Under the thermal loads typical of the ESRF, silicon monochromator are almost at their physical limits and diamonds are still quite unstable in the beam. It is therefore necessary to explore the concept of broadband pre-monochromators as archetypes for more stable beamlines. Research and development will be necessary for the manufacturing and assessment of the optical components capable of withstanding the full power of the X-ray beams, whilst preserving their brilliance and coherency. The optimisation of stable slits and coherence preserving attenuators and filters is still far from being reached, and development is still necessary for bolometers, beamsplitters and high power beam position monitors. New mechanics, and in particular active mechanics, have to be developed and tested.

A white beam test line would be also very useful for testing the radiation endurance of beamline components as cameras, electronic components and seals, and for quickly screening diamond and multilayer optics.

Structure

The beamline would serve a variety of European communities. Availability of space, rail construction and operational flexibility is of prime importance. The beamline structure would be essentially based on benches equipped with appropriate hydraulic manifolds, thermal control apparatuses, infrared cameras, beam position monitors, gas lines and detectors. Beam Position Monitors and cameras will need their appropriate radiation shielded enclosure.

Context with new sources and user community

The ESRF is the only operational European high energy facility. This means that tests and developments on high energy, high heat load beams can only be carried out at the ESRF. In this regard, the experience accumulated at **WIBIDI** is unique and of exclusive importance for all European facilities.

Technical considerations

The beamline has to take in account the safety constraints imposed by the use of white beam in and out of vacuum. This may have a secondary impact on the structure of the local shielding for electronics and microelectronics components in general.

Introduction to the Conceptual Design Reports of the X-ray Absorption and Magnetic Scattering Group

The Conceptual Design Reports included here reflect in depth thinking with regards to the evolution of experimental facilities at the ESRF and how significant steps in the science that could be performed in the future could be made. The ideas are certainly only a subset of what is possible but would already represent a radical change from what is available today. All of these projects would require significant resources, but it should be clear that the proposal to have very high static magnetic fields represents a major advancement compared with what is available today and could only happen within the context of an Upgrade Programme and in collaboration with other local and European partners.

All of the five priority areas highlighted by the ESRF Scientific Advisory Committee are covered to a greater or lesser extent. Although *Structural and*

Functional Biology and Soft Condensed Matter applications are not those that the emphasis will be put on, absorption spectroscopy can and will contribute in the future. *X-ray Imaging* is also only explicitly dealt with in the "microprobe" proposal (EDXAS-S). However, many of the projects fall strongly into the important areas of *Nanoscience and Nanotechnology* (DICHRO, EDXAS-L, EDXAS-S, MAGSCAT, PMF, RIXS-PES, SMS), *Pump-and-Probe and Time-Resolved Science* (DICHRO, EDXAS-L, EDXAS-S, PMF, SMS) and *Science at Extreme Conditions* (DICHRO, EDXAS-S, EXAFS, MAGSCAT, PMF, SMS).

The CDRs presented here are examples of significant steps that could be made in the development of the Group beamlines. All of the ideas presented would open up new possibilities for science in the future. In particular, the projects requiring very high static

Summary of individual CDRs

| | | |
|-----------------|--|----------|
| DICHRO | Polarisation Dependent X-ray Spectroscopy: High precision X-ray spectroscopy beamline using optical activity for the study of magnetic materials. The proposed high magnetic field end-station will offer magnetic fields more than two times higher than presently available. | page 83 |
| EDXAS-L | Energy Dispersive Absorption Spectroscopy (large spot): <i>In operando</i> time resolved studies of functional materials and processes on the millisecond timescale, exploiting the parallel data acquisition inherent to the energy dispersive XAS method. | page 87 |
| EDXAS-S | Energy Dispersive Absorption Spectroscopy (small spot): Microprobe applications such as fluorescence mapping and absorption spectroscopy under high pressure, exploiting the small focal spot and ultimate stability of the energy dispersive XAS method. | page 87 |
| EXAFS | Extended X-ray Absorption Fine Structure Spectroscopy: High throughput X-ray absorption spectroscopy up to very high photon energies and under extreme conditions. | page 92 |
| MAGSCAT | Magnetic Scattering: Resonant scattering using polarised X-rays for the investigation of correlated electron systems under extreme conditions. The proposed high magnetic field end-station will enable diffraction studies of quantum criticality. | page 96 |
| PMF | Pulsed Magnetic Fields: The extrapolation of recent pilot studies based on optimised magnet and power supply designs with the goal to supply pulsed magnetic fields up to 60 T to X-ray diffraction and spectroscopy experiments. | page 99 |
| RIXS-PES | High Resolution Resonant Inelastic X-ray Scattering and Photoelectron Spectroscopy: Small spots and very high energy resolution would open up new possibilities in studies of the electronic properties of materials based on 3d transition metals, lanthanides and technological semiconductors. | page 103 |
| SMS | Resonant Soft X-ray Magnetic Scattering: Diffraction studies of single crystals, multilayers and nanostructured materials exploiting the giant magnetic resonances occurring in the soft X-ray range. | page 106 |

DICHO: Polarisation Dependent X-ray Spectroscopy

Summary

magnetic fields (DICHO, MAGSCAT) are radical steps towards these possibilities and cannot be envisaged under current circumstances. Totally new science would result and would lead to significant improvements of our understanding of the dynamical properties of matter and under extreme conditions.

These CDRs should not be considered in isolation, as there are links with other design reports and the microprobe proposal (EDXAS-L) is proposed jointly with the X-ray Imaging Group. In addition, there are many synergies between projects. One example is absorption spectroscopy where synergy with other design reports (*e.g.* SMILE, XMAN, XAS-XES) could provide a unique absorption spectroscopy platform. In general there is synergy across groups in all the investigations of the electronic, chemical and magnetic properties of materials.

On the one hand the future projects will require significant improvements to the detectors, optics and the source and, on the other hand, infrastructure to enable and cope with new experiments. X-ray optics beyond the state-of-the-art optics currently used and detectors with unprecedented properties will both be mandatory. All experiments will gain from improved source stability, most from a higher brilliance source and new long straight sections and the option of implementing canted undulators with a brilliance similar to today's full length 5 m straight sections. In addition, the experiments of the future will require *in situ* nanohandling and characterisation tools as well as proper off-line support facilities around the experiment. For example, if we are to meet the demands of *in operando* experiments for academic and industrial research, such significant investment in infrastructure is a necessity. Finally, dedicated power lines, purpose built buildings and support facilities are required for the very high static magnetic field project.

This proposal is for an upgrade of the present ID12 beamline, which is dedicated to polarisation dependent X-ray spectroscopy in the medium to hard X-ray region. This upgrade is aimed at the further development of methods and instrumentation that have been initiated at the beamline and have already provided clear evidence of the importance of polarised X-rays to study fundamental properties of matter via various order parameters (*e.g.* spin and orbital moments, electric dipole moment, orbital anapole). To deepen our understanding of these order parameters and to elucidate their role in magnetic phase transitions, it is highly desirable to perform dichroism experiments under very high static magnetic fields of up to 35 Tesla. Dynamic responses in magnetic systems, with chemical selectivity and with separate determination of the dynamics of spin and orbital magnetisations, would be possible with a completely new technique based on the X-ray detection of magnetic resonance.

With the proposed upgrade, new and unique research opportunities will be open, from which a wide user community will benefit. This upgrade should allow the beamline to remain an outstanding facility devoted to research at the ultimate limits of X-ray spectroscopy with polarised synchrotron radiation.

Scientific case

With the advent of the third-generation synchrotron radiation facilities, X-ray spectroscopies have been undergoing a continuous expansion, as illustrated by the discovery of a variety of new experimental techniques associated with the exploitation of the polarisation properties of synchrotron radiation. The detection of X-ray magnetic linear and circular dichroism (XMLD, XMCD) in ferro-, ferri- and paramagnetic systems (for a recent review, see Rogalev *et al.* (2006) and references therein), the discovery of X-ray natural circular dichroism (XNCD) in gyrotropic single crystals (Goulon *et al.*, 1998) and, more recently, the observation of non-reciprocal X-ray linear dichroism (XnrLD) (Goulon *et al.*, 2000) and X-ray magneto-chiral dichroism (XM χ D) (Goulon *et al.*, 2002) in magnetoelectric antiferromagnets are particularly interesting.

These new spectroscopies featuring element and orbital selectivities have proved to be remarkable tools for the investigation of the electronic and magnetic structure of various materials: crystals,

molecules, multilayers, monolayers, nanoparticles etc. The major strength of XMCD is the capability of this technique to disentangle orbital and spin contributions to the total magnetic moment carried by the absorbing atom (Thole *et al.*, 1992; Carra *et al.*, 1993) and to measure the anisotropy of the magnetic moment. Three other techniques are manifestations of X-ray optical activity (XOA) and are very valuable in studying systems with broken inversion symmetry. Such systems play a fascinating role not only in physics but also in chemistry and in life sciences, where molecular recognition processes are controlled by chirality. Moreover, X-ray optical activity appears as a new, element specific spectroscopy to study orbital magnetism in parity non-conserving solids and offers unique experimental access to orbital anapole moments and to related operators (Goulon *et al.*, 2003).

External magnetic fields in X-ray dichroism experiments are mainly used either to align magnetic domains or to grow preferentially one type of domain with magneto-electric annealing. The required field is rather low and the largest part of the H-T phase diagram of matter remains unexplored. To get new insights into microscopic origin of magnetic phase transitions and new magnetic states we propose to extend XMCD and XM χ D experiments to paramagnetic systems under a *static* magnetic field of up to 35 Tesla. The use of high magnetic fields has already opened new directions in solid state physics research and its combination with X-ray dichroism should contribute to the understanding of complex physical phenomena, such as meta-magnetism, exchange bias, magneto-electric and magneto-caloric effects and many others. Studies of paramagnetic chiral systems under high magnetic field would provide us with a unique possibility to study space-time symmetry violations that are of fundamental interest in atomic, molecular and solid state physics.

Sub-picosecond magnetism and spin dynamics are new domains of science and time-resolved XMCD at this timescale should become a state-of-the-art technique at the XFEL facilities. At the third-generation facility, like the ESRF, the use of the frequency domain is more favourable, whilst the underlying physics remains the same. It has been recently illustrated by the first measurements of X-ray detected magnetic resonance (XDMR) (Goulon *et al.*, 2005) on a ferri-magnetic thin film of yttrium iron garnet. This pump-and-probe technique is the only spectroscopy that allows one to study dynamic aspects of orbital magnetism and, therefore, could be seen as the dynamic extension of XMCD. To date, our XDMR experiments operate at 10 GHz, but, if we could transpose them to a standard superconducting 6 Tesla magnet, XDMR spectra could be recorded at 100 to 140 GHz using a pulsed gyrotron synchronised with the X-ray pulses. This would open

new possibilities to study with element and orbital selectivity of XMCD the *ferro-, para- and anti-ferromagnetic* resonances, and perhaps *nuclear magnetic resonances* enhanced via dynamic nuclear polarisation. There is no doubt that extension of XDMR to higher magnetic fields is extremely attractive. This indeed will make sense only if high power THz sources are available.

Context with new sources and user community

Polarised X-rays in the soft and intermediate energy range are and will be used at any medium energy (3 GeV) third-generation synchrotron facility, so that one may question the specificity of the ESRF in this important field of research. The reply to this question is not new: these new facilities will not be able to compete with the ESRF in terms of *stability* which will be the critical issue for the years to come: they will not have the capability to offer a beam life time of 60 hours as delivered everyday at the ESRF. Topping up does not currently look to be a solution to maintain electron beam stability. Moreover the sensitivity of the electron beam position to external perturbations is much higher for low energy machines. These two issues are of paramount importance regarding differential techniques requiring full control of the polarisation by the users.

Time-resolved XMCD experiments with a sub-picosecond resolution are under way at many third-generation facilities and are expected to become even more effective with use of the XFEL facilities. Since at the moment there is no easy way to generate shorter X-ray bunches at the ESRF without a significant loss of flux, we propose to work in the *frequency domain* (which is in any case more comfortable for spectroscopists) rather than in the time domain: the underlying physics *remains the same*.

As far as X-ray experiments under high magnetic fields are concerned, the strongest steady state magnet (15 T) is installed at SPRING-8. Moreover, there are active research programmes at both the ESRF and SPRING-8 concentrated on use of pulsed magnets producing fields up to 60 T. We have to mention a proposal from APS to develop and use a high static magnetic field (30 to 40 T) produced by a hybrid magnet. All these magnets are used or intended to be used for hard X-ray scattering studies. Our proposal concerns the development of a 35 T magnet dedicated for X-ray spectroscopy in the intermediate and hard X-ray range.

Technical considerations

X-ray source

The originality and the specificity of the beamline derive from the "exotic" nature of the sources: helical undulators. Using the full benefit of a long straight section, four different helical undulators, either of EMPHU (ElectroMagnet/Permanent magnet Hybrid Undulator) or of HELIOS type, can be installed. The undulators will be optimised to complement each other and would allow users to have full control of the polarisation state of the X-ray beam over a wide energy range (1.5 to 20 keV). To provide users with higher fluxes of polarised X-rays in a given spectral range, we consider it a possibility to phase two HELIOS undulator segments which could be mounted on revolver type mechanics. The 10 mm vacuum chamber allows one to use a rather short period helical undulator to generate high flux of polarised X-rays in the energy range below 4 keV.

Beamline optics

The optical layout of the beamline is not going to be significantly different from the existing one. In order to preserve its good performance in the soft or intermediate X-ray ranges, the beamline remains as windowless with clear implications regarding the design of UHV compatible components. As the first optical component of the beamline we propose to keep a pair of CVD-SiC mirrors set in an antiparallel (+,-) configuration but to replace the existing four mirror device with an improved, more efficient two mirror system. The role of this system becomes even more important with the prospect of extending the energy range of the beamline below 2 keV: it will be essential to reject as much as possible of the unwanted higher order harmonic emissions with a pair of SiC mirrors in order to reduce the heat load on the first crystal of the monochromator and minimise the eventual radiation damage.

The key component of the beamline is a UHV compatible double crystal, double cam monochromator equipped with two pairs of crystals. In a standard configuration we would use a pair of Si(111) crystals, whilst for the experiments with circular polarisation in the intermediate energy range (1.5 to 4 keV) we envisage using a pair of crystals with larger 2d spacings, *e.g.* beryl or KTiOPO_4 (KTP). In order to be able to fully characterise the polarisation state of the monochromatic beam downstream of the monochromator a UHV compatible X-ray phase plate chamber equipped with a diamond single crystal is permanently installed at the beamline.

A pair of focusing mirrors (VF-2M device) is also installed downstream of the monochromator. The choice of this configuration was dictated by two considerations:

- (i) the VF-2M device should not affect the energy resolution of the monochromator
- (ii) large demagnification factors could be obtained for samples located close enough to the mirrors assuming that the curvature of the mirrors can be increased without damaging their figure slope error. Vertical focus sizes down to 20 micrometres (FWHM) have to be routinely obtained at the sample location whilst using the full undulator beam.

Detectors

All standard fluorescence detectors, all beam intensity monitors or beam position monitors at the beamline are (single- or multi-anode) ion implanted Si PNN⁺ photodiodes operated mostly in the photovoltaic mode. Over the past 15 years, these detectors have been carefully optimised for our specific applications (Goulon *et al.*, 2005). Very high efficiency, fast response time, excellent linearity, full UHV compatibility and insensitivity to magnetic fields make photodiodes the most suitable detectors for X-ray spectroscopy. Much effort has been invested over more than ten years by the beamline staff in order to develop new solid state detectors optimised for our specific applications. A typical example is development of fast detectors which should give us the capability to fully exploit at least the macrobunch time structure of the X-ray beam. Special photodiodes featuring a very low capacitance have been produced in close collaboration with Canberra Semiconductors and a very fast preamplifier has now been developed within our team. The data acquisition system exploits a powerful multi-channel Vector Signal analyser (AGILENT) equipped with 23 bit, 100 MSa/s digitisers developed mainly for telecommunication (and military) applications. This equipment made it possible to detect the XDMR signals smaller than 10^{-6} with respect to the edge jump. Moreover it is in use to analyse the non-statistical noise power spectral density of the ESRF X-ray source. We hope to equip the beamline with detectors which could detect modulated signals of very low intensity at frequency up to 40 MHz, or even 352 MHz. This is of interest not only for XDMR but also for the detection of X-ray circular dichroism in magnetoelectric (ME) systems using a high frequency modulation of the electric field: again we hope to push the sensitivity of such measurements below the ppm limit.

For experiments requiring energy resolution, a 35 element silicon drift diode (SDD) detector array has been developed in collaboration with Eurisys-Mesures (now Canberra Eurisys). This detector consists of an array of 7 x 5 cylindrical SDDs with an active area of 10 mm² for each diode. It is operated systematically windowless: this allowed us to extend the operation of the detector down to the soft X-ray range where there is a lack of good energy resolved detectors. Seen from the users' side, this development has opened the possibility to investigate with XMCD the

magnetic properties of buried submonolayers, nanoparticles, the paramagnetism of impurities in diamagnetic matrices, the magnetism of ad-atoms on surfaces etc.

New experimental end-stations

• X-ray Magnetic Dichroism under High Magnetic Field

The key element of this end-station is a superconducting solenoid producing a static magnetic field in the horizontal plane and set to be parallel to the incoming X-ray beam. One can consider at this point two possible scenarios. A conservative one is based on the use of a commercial superconducting solenoid with maximum magnetic field of about 20 Tesla. Another, ambitious scenario consists of developing a "non-standard" hybrid electromagnet capable of producing a magnetic field of 35 Tesla or even higher. This type of device is expensive and demands considerable infrastructure to bring 10 to 20 MW of electrical power and rectify it as well as a good and efficient cooling system. This action will make sense only if the infrastructure is shared between few magnets installed at different beamlines and/or shared with the ILL.

• X-ray Detected Magnetic Resonance

X-ray detected magnetic resonance is a novel spectroscopy in which X-ray magnetic circular dichroism is used to *probe* the resonant precession of the magnetisation caused by absorption of strong microwave *pump* radiation. The frequency range of the pump waves is huge since it starts from a few MHz with NMR and extends up to the THz range for AFMR on superconductors in the far-IR. Based on our present analyses, we expect XDMR to develop simultaneously in different directions:

(i) Regarding *ferromagnetic materials and thin films*, the needs will develop principally in the low frequency domain: *i.e.* from the RF range (few tens of MHz) up to the so-called Q-band (40 GHz). These experiments will require a very high pump power that could be obtained by using microwave amplifier modules based on a travelling wave tube. To avoid thermal drifts caused by the microwave losses in the sample at resonance, one should use very short microwave pulses with high peak power but at a rather low duty cycle. The selection of the pulse length and of the pulse repetition rate will, however, strongly depend on the filling pattern of the ESRF machine.

(ii) Regarding *paramagnetic materials*, the limitations have a different origin: the XDMR signal is expected to be very small unless the experiments can be performed at very low temperature, high bias magnetic field and high microwave frequency. Even though it has not been observed yet, we are quite confident that the XDMR signal of paramagnetic

samples could be recorded in the longitudinal geometry using a strong pump power in the mm-wave range using a high magnetic bias field. For example, X-ray detected electron spin resonance could be detected in a standard superconducting magnet at 100 to 140 GHz using a pulsed gyrotron with modest average power. Besides direct measurements of relaxation times T_1 and T_2 , one can dream of accessing to the hyperfine structures of XDMR spectra. Moreover, this would open as well new possibilities of studying dynamics of orbital polarisation in systems with high magneto crystalline anisotropy and, perhaps, X-ray detected nuclear polarisation.

(iii) The case of ferrimagnetic or *anti-ferromagnetic materials* is most fascinating but, unfortunately, also the most complicated one. Whereas XMCD cannot be measured for antiferromagnetic materials, it may look paradoxical to try to detect XDMR on antiferromagnets. Nevertheless, this is possible because the precession angles of the two coupled sublattices are different. Technically, the problem is that AFMR is usually observed in the THz region where high power sources of radiation are very few. As far as XDMR experiments are concerned, a compact "table-top" THz free-electron laser source delivering 10 – 100 W average power seems to be the most attractive. However, to perform these experiments, a rather high external magnetic field is again required.

References

- Carra P., Thole B.T., Altarelli M., and Wang X. (1993), X-ray Circular Dichroism and Local Magnetic Fields, *Phys. Rev. Lett.*, **70**, 694-697.
- Goulon J., Goulon-Ginet Ch., Rogalev A., Gotte V., Malgrange C., Brouder Ch., and Natoli C.R. (1998), X-ray Natural Circular Dichroism in a Uniaxial Gyrotropic Single Crystal of LiIO_3 , *J. Phys. Chem.*, **108**, 6394-6403.
- Goulon J., Rogalev A., Goulon-Ginet Ch., Benayoun G., Paolasini L., Brouder Ch., Malgrange C., and Metcalf P.A. (2000), First Observation of Nonreciprocal X-ray Gyrotropy, *Phys. Rev. Lett.*, **85**, 4385-4388.
- Goulon J., Rogalev A., Wilhelm F., Goulon-Ginet Ch., Carra P., Cabaret D., and Brouder Ch. (2002), X-ray Magnetochiral Dichroism: A New Spectroscopic Probe of Parity Nonconserving Magnetic Solids, *Phys. Rev. Lett.*, **88**, 237401.
- Goulon J., Rogalev A., Goujon G., Gauthier Ch., Moguiline E., Sole A., Feite S., Wilhelm F., Jaouen N., Goulon-Ginet Ch., Dressler P., Rohr P., Lampert M.-O., and Henck R. (2005), Advanced Detection Systems for X-Ray Fluorescence Excitation Spectroscopy, *J. Synch. Rad.*, **12**, 57-59.
- Goulon J., Rogalev A., Wilhelm F., Goulon-Ginet Ch., Carra P., Marri I. and Brouder Ch. (2003), X-Ray Optical Activity: Applications of Sum Rules, *J. Exp. Theor. Phys.*, **97**, 402-431.
- Goulon J., Rogalev A., Wilhelm F., Jaouen N., Goulon-Ginet Ch., Goujon G., Ben-Youssef J., and Indenbom M.V.

(2005), X-Ray Detected Magnetic Resonance: First Evidence of Forced Precession of Polarized Orbital Components, *JETP Lett.*, **82**, 696-791.

- Rogalev A., Wilhelm F., Jaouen N., Goulon J., and Kappler J.P. (2006), X-ray Magnetic Circular Dichroism Historical Perspective and Recent Highlights, in: Beaurepaire E., Bulou H., Scheurer F. and Kappler J.P. (Eds.), *Magnetism: A Synchrotron Radiation Approach*, Lecture Notes in Physics, Vol. 697, p. 71, Berlin: Springer Verlag.
- Thole B.T., Carra P., Sette F., and van der Laan G. (1992), X-ray Circular Dichroism as a Probe of Orbital Magnetization, *Phys. Rev. Lett.*, **68**, 1943-1946.

a) EDXAS-S: Energy Dispersive Absorption Spectroscopy (small spot)

b) EDXAS-L: Energy Dispersive Absorption Spectroscopy (large spot)

Summary

We propose to add to the present ESRF capabilities a new energy dispersive XAS (EDXAS) beamline, working in the hard X-ray range (5 to 30 keV), optimised to perform XAS with a sub micron spatial resolution. The beamline offers opportunities for a large variety of user communities that require the combination of an X-ray spectroscopic tool, spatial mapping and fast timescales. We give here one example of application in the field of Earth science.

We also propose to optimise the present EDXAS beamline (ID24) for time-resolved studies of functional materials and processes and all related activities not compatible with a small spot due to intrinsic particle size limitations. For clarity, in the following we will refer to these two beamlines as EDXAS-S (small spot: ~ 1 μm full size) and EDXAS-L (large spot: ~ 50 μm full size). We propose to implement the two EDXAS beamlines on the same high- β straight section of the ring, using canted insertion devices.

A. Scientific case for EDXAS-S

Non-uniform environments where the spatial inhomogeneity is of the order of one micrometre are ubiquitous in the three broad categories of earth/environmental, material/archaeological and chemical/biological sciences. Until recently, there

have been few tools to investigate such systems, none of which were regarded as ideal. Sub-micron EXAFS, combined with fast acquisition, has the potential to provide previously unattainable insights into the structure and chemistry of a species, how these are related to its function and to that of other species that may coexist in complex systems and how they evolve with time. The energy dispersive geometry optimised for sub-micron spots offers a unique combination of high lateral resolution and millisecond acquisition times for a whole spectrum. Developments carried out on ID24 have shown that the dispersive concept is very powerful not only in its traditional transmission geometry, but also for fluorescence detection (Pascarelli *et al.*, 1999; Pascarelli *et al.*, 2006). This beamline will open the way to completely new applications that have, up to now, been impossible, such as two and three (using XAFS tomography) dimensional mapping of valence state/local structure at the (sub)micrometre scale in inhomogeneous systems in static or time evolving conditions.

The availability of a bright X-ray spot of a few hundred nanometres full width at half maximum (FWHM), associated with time resolution would open a wide new window into deep Earth processes. In particular, this would give the unique opportunity to probe the chemistry of individual high pressure phases of the order of one micrometre in diameter at equilibrium conditions in a complex chemical system such as that of the Earth. On samples synthesised at very high pressure and temperature in a diamond anvil cell (DAC) and subsequently quenched, it would allow routine measurements on the structure of the phases produced with the required spatial resolution. At present, only the composition can be measured by analytical transmission electron microscopy (ATEM) after preparing the sample by focused ion beam (FIB) techniques, or by nano-secondary ion mass spectrometry (nano-SIMS), which still awaits validation. Both these methods are destructive and do not permit *in situ* studies.

In situ studies of chemical reactions (Frost *et al.*, 2004; Dubrovinsky *et al.*, 2003) element partitioning (Wood *et al.*, 2006; Frost *et al.*, 2003) and kinetics of processes in internally (laser- or electrically-) heated DACs is currently impossible. The present spot sizes for XAS spectroscopy do not allow the different phases and diffusion process kinetics to be probed with sufficient lateral resolution within the laser hot spot. A sub-micron spot would enable a chemical image to be made of a 10 x 10 μm^2 area, with a spatial resolution better than one micrometre and full EXAFS information on each pixel. EXAFS (but also XANES) spectra of solid and liquid phases are easily distinguishable and chemistry sensitive. Moreover, XANES spectra could provide direct information on the oxidation states of elements (iron, for example) during *in situ* high pressure and temperature

experiments. This information can give a fundamental contribution to model partitioning processes, for example between liquid and solid phases in Fe-Ni-L (L=Si, O, S, Al, Mg) alloys and compounds at the conditions of Earth's core and answer many enigmatic questions related to formation and differentiation processes of Earth and other planets (McCammon, 2005).

The size of the spot combined to the time resolution would also allow the characterisation of diffusion processes at conditions of high pressure and temperature. This is an important issue in Earth Sciences, since heterogeneous material is permanently mixed in the mantle due to convection. Amongst geodynamicists and geochemists, a recurrent concern is the size and the life time of these heterogeneities. Depending on the time resolution, it would be possible to characterise fast phase transitions, accessing intermediate metastable steps not yet seen, etc. Processes such as crystallisation, element fractioning, dissolution and diffusion are not known at the micrometre scale under extreme conditions. Such processes are strongly dependent on the cooling/heating kinetics. For example, the determination of the ferric:ferrous ratio in magmas is challenging because these silicate melts crystallise and lose most of their volatile constituents upon ascent. Glass/melt inclusions trapped at high temperature in olivine are generally a few microns in diameter. Spatial mapping of the $\text{Fe}^{3+}/\Sigma\text{Fe}$ ratio and speciation during rapid cooling in such systems is, as of today, impossible.

Very little information is available on transport properties of deep Earth minerals, which control different aspects of globe dynamics and its evolution with time. Concerning atomic diffusion, there are a few important examples:

- The fate of slabs subducted in the deep mantle as a result of plate tectonics and mantle convection. These slabs are made of oceanic crust, which has a different chemical composition compared to the mean lower mantle. Knowledge of atomic diffusion coefficients is required to model slab evolution and its eventual dissolution into the lower mantle.
- Concerning the Earth's core, it is known that the inner core crystallisation induces rejection of various chemical elements to the liquid outer core. This produces a very important effect on convection in the outer core that is an important parameter to maintain the Earth's Geodynamo. This effect is limited by the atomic diffusion into liquid iron which is poorly constrained. Note that measuring atomic diffusion in liquid iron at high pressure also gives quantitative data about iron viscosity.
- A last example concerns the chemical relationships at the core-mantle boundary, where there could still be exchange of material at present, due to remaining disequilibrium at this chemical boundary, but the

whole problem is poorly constrained. Measuring the chemical composition and the diffusivity at the contact between mantle silicates and iron alloys would be required (Bouhifd *et al.*, 2006).

B. Scientific case for EDXAS-L

The present ID24 is the only energy dispersive XAS beamline worldwide on a high brilliance undulator source. This makes it a unique instrument for fast time-resolved XAS applications, allowing sub-millisecond time resolution studies of non-reversible processes. In the past few years, this beamline has been upgraded to become a unique experimental platform for synchronous vibrational/electronic spectroscopies in conjunction with X-ray techniques for applications in catalysis, chemistry and material science.

Specifically, time-resolved diffuse reflectance IR/XAFS (soon also UV-Vis/XAFS) for heterogeneous catalysis/materials science/solid state chemistry and stopped flow UV-Vis/XAFS for homogeneous catalysis/biological catalysis/ion binding/precipitation chemistry have been implemented to provide the potential for the *in situ* determination of structure function relationships from both structural and vibrational spectroscopic view points. This experimental capacity is made mobile and, whilst centred on the EDXAS beamline, will be available to ESRF staff on other beamlines.

The uniqueness of this beamline for studies in chemistry and catalysis is reflected in the growing interest that the Japanese automotive industry has shown since 2003 in carrying out proprietary research on their catalysts. Considering the growing interest in studies on pollution control, these activities are likely to continue in the future.

It is from this framework that we propose to dedicate the present ID24 (future EDXAS-L) completely to time-resolved studies of functional materials and processes, to embrace a broad field from chemistry to catalysis to materials science. This instrument will therefore finally have the means to fully express its potential for these user communities (including industry), remain competitive and at the forefront of research, without having to undergo compromises in beam characteristics and sample environment for orthogonal applications.

The scientific case for such an instrument is very wide and we list here only some areas where opportunities can arise:

- **Detection of Intermediate species** (Newton *et al.*, 2007; Guilera *et al.*, 2006)
Intermediate reactive species have been studied mostly to explain the chemistry and reactivity of

many catalytic systems. However, to date, there are practically no experiments that allow direct and simultaneous determination of structure and reactivity. EDXAS-L will offer the potential for as complete a description of a wide range of reactive systems as is currently possible with the internal self consistency that comes from achieving these aims in a single, *in situ* experiment.

- **Dynamic High Pressure Chemistry:** (Grunwaldt and Baiker, 2005) pressure jump/modulation techniques using EDXAS allied to IR/UV-vis (fuels cells, real industrial chemistry, hydrogen storage, enantioselective catalysis).
- **Photochemistry/catalysis:** (Fernández-García *et al.*, 2004) Fe and W dopants in TiO₂ powders and films for TiO₂-based solids with actual or potential application in innovative photocatalytic decontamination processes for environmental and health protection.

One can anticipate that EDXAS-L, combined with an upgrade of the source and refurbishment with faster detectors, will remain a reference beamline for at least the next ten to fifteen years, unique amongst the world's existing synchrotrons and will represent a new, attractive, paradigm for the manner in which synchrotrons interact with industrial and academic user bases.

Integration of EDXAS-S and EDXAS-L into the five scientific highlight areas and cross-collaboration/complementarity with other beamlines

Parallel acquisition of the XAS spectrum coupled to fast time resolution and small focal spots place EDXAS at high brilliance sources in a central position with regards to the new and emerging scientific fields. The areas which provide the most important opportunities for cutting edge experiments are:

- **Science at extreme conditions (EDXAS-S)**
Studies at extreme conditions of pressure and temperature in the diamond anvil cell (DAC) historically represent one of the main applications of EDXAS. The availability of a sub-micron stable focal spot for DAC studies will extend the capabilities in this field to include, for example, accurate 2D EXAFS mapping across the *in situ* laser heated spot (typically ~10 µm in diameter) to deal with the inevitable and important temperature gradients. Knowledge of the variations in oxidation state and site partitioning as a function of temperature at a given pressure will become accessible, but also the follow up with millisecond time resolution of chemical reactions at extreme conditions of temperature and pressure. Close collaboration with the high pressure beamlines

(at present ID27 and ID09b, CDR HIPRE) is to be anticipated.

- **X-ray imaging (EDXAS-S)**
2D mapping of heterogeneous samples with full EXAFS information on each pixel is a novel application of EDXAS (Pascarelli *et al.*, 1999; Munoz *et al.*, 2006; Vidal *et al.*, 2006). This new instrument will allow rapid acquisition of full 2D maps with sub-micron spatial resolution, in fluorescence (100 ms/spectrum) or transmission mode (ms/spectrum). The rapid acquisition of full EXAFS spectra with a ~300 nm FWHM spatial resolution will open new horizons to the present landscape of EXAFS applications. This represents an improvement of approximately one order of magnitude to the present performance. In this field, close collaboration with the scanning microspectroscopy beamlines (at present ID21 and ID22, CDRs SMILE and XMAN) is to be anticipated. The main advantage over classical scanning XAS microprobe instruments lies in the absence of movement of the optics during acquisition (leading to an improved energy scale and focal spot stability) and speed, which makes these studies feasible on reasonable timescales. On the other hand, this instrument will lack the flexibility to perform quick energy changes to acquire XRD *in situ*, and will not be able to compete flux-wise with scanning instruments for studies on ultra dilute systems. It will therefore be very complementary to ID22 and the current ID26 (CDR XAS-XES).

- **Pump-and-probe experiments and time-resolved absorption (EDXAS-L and EDXAS-S)**
The simultaneous acquisition of the whole XAS (or XMCD) spectrum at each pump-and-probe cycle represents a real advantage for studies at extreme conditions that can be produced only for limited periods of time (*i.e.* very high magnetic field pulses (Bonfim *et al.*, 2000) or laser excitation). Picosecond time resolution can be achieved using specific detection systems. A combination of temporal and spatial resolution allows sample probing at a specific distance from the perturbation (*i.e.* laser impact), to see how it propagates in the material and with what speed. One can anticipate strong complementarities with pump-and-probe diffraction methods (present ID09B, CDR TRD) and pump-and-probe single energy fluorescence XAS (present ID26). Differential EXAFS, a novel technique for the study of small atomic strains, also falls into the pump-and-probe category, since it relies on examining tiny differences in X-ray absorption spectra - taken under high stability, low noise conditions - generated by unit modulation of some sample bulk parameter (*i.e.* a magnetic field (Pettifer *et al.*, 2005) or a temperature gradient). Information on magnetostriction at the atomic level at extreme conditions becomes accessible (Pascarelli *et al.*, 2006).

Techniques

- Energy dispersive X-ray absorption spectroscopy
- Sequential acquisition of X-ray absorption using dispersive optics
- Energy dispersive X-ray magnetic circular dichroism
- Angle resolved X-ray diffraction

Context with new sources and user community

The main competing dispersive XAS beamlines will be:

1. ODE (SOLEIL): a dedicated bending magnet dispersive XAS beamline that will focus its activities on studies of magnetism at extreme conditions. Expected spot size $\sim 20 \mu\text{m}$ FWHM. Energy range: 3.5 to 25 KeV.
2. MARS (SOLEIL): a multipurpose bending magnet beamline for XAS, XRD and Dispersive XAS on radioactive samples.
3. Multipurpose XAS (DIAMOND): a multipurpose scanning XAS wiggler beamline that will cover X-ray absorption and emission spectroscopies, XRD and have an option for dispersive XAS focused on time-resolved chemistry activities. Expected spot sizes ~ 70 (h) \times 25 (v) μm FWHM. Energy range: 6 to 35 KeV.
4. BL14B1 (SPRING-8): materials science bending magnet. Dispersive XAS is an option and activities are focused on time-resolved chemistry.
5. BL28B2 (SPRING-8): white beam X-ray diffraction bending magnet. Dispersive XAS is an option and activities are focused on time-resolved chemistry.
6. Other dispersive XAS beamlines are operational/planned at LNLS (Brazil), PHOTON FACTORY (Japan) and Indore (India).

In the landscape of EDXAS beamlines worldwide, EDXAS-L would remain the only energy dispersive XAS dedicated instrument for time-resolved activities, and EDXAS-S would have no competition.

Technical considerations

EDXAS-L and EDXAS-S are two specialised beamlines, matching two different scientific domains. EDXAS-S is designed to study inhomogeneities at the level of the micrometre whereas EDXAS-L is optimised to yield average information on a scale of several tens of micrometres. Building two specialised beamlines on a canted sector is meaningful only if the characteristics of the two X-ray beams perfectly match the scientific goals. The main difference between EDXAS-L and EDXAS-S resides in the size of the X-ray probe: full spots of the order of $25 \times 100 \mu\text{m}^2$ and about $1 \times 1 \mu\text{m}^2$ (H \times V) respectively. The technical options to fulfil these conditions are also constrained, for both beamlines, by the requirement of producing a sufficiently large energy bandpass after diffraction by the polychromator. This leads to a required incoming horizontal divergence of about 1 mrad on the polychromator.

EDXAS-S

The EDXAS-S beamline principle and the technical options are largely inspired from the present EDXAS beamline ID24. The optimisation of the positions and the quality of the optical components are the main challenges to fulfil the requirements outlined above for this instrument.

An undulator X-ray source on a high beta straight section coupled with a horizontally focusing mirror to enhance the divergence up to the required value is an adequate choice for this project as (i) the demagnification factor resulting from the coupling of the polychromator with the horizontal mirror meets the focal spot requirements, (ii) the high flux delivered by the undulator source is necessary to cope with the scientific goals of the project (two orders of magnitude higher than an option based on a BM), (iii) the heat load on optical elements will be minimised, especially on the polychromator and (iv) the small vertical divergence allows the size of the vertical focusing mirror to be minimised. Two revolver undulators (32 mm and 27 mm period) on a canted straight section can cover the requirements of EXAFS measurements in the 5 to 30 keV energy range.

With respect to the optical scheme of the present ID24, the principal difference will be in the inversion of the mirrors of the KB system: the vertical focusing

| | Description | Position (m) | q (m) | θ_i | Slope error (μrad) |
|-------|---|--------------|-------|--------------|---------------------------------|
| M1 | horizontal focus and harmonic rejection | 31 | 0.5 | 3 mrad | 1.0 |
| M2 | vertical focus and harmonic rejection | 66 | 8 | 3 mrad | 1.0 |
| poly. | polychromator and horizontal focus | 69 | 0.7 | 16.4° | 1.0 |
| M3 | vertical focus and harmonic rejection | 69.35 | 0.35 | 3 mrad | 0.5 |

mirror will be positioned as close as possible to the sample position, as slope error contribution from this mirror is presently the limiting factor on the vertical spot size.

A long beamline is not necessary for this project as first design parameters demonstrate that the source contribution to the final focal spot size becomes rapidly negligible compared to contributions due to slope errors on the polychromator and on the vertical mirrors. The parameters shown in the table, leading to a focal spot size of $1.5 \times 1.3 \mu\text{m}^2$ (FWHM) with slope error values available today, represent a possible good compromise between energy bandpass, size of optical elements and focal spot requirements.

Anticipating the future trends in optimisation of surface quality and X-ray metrology, slope errors of the order of $0.2 \mu\text{rad}$ (FWHM) will yield a focal spot of about $0.4 \times 0.4 \mu\text{m}^2$ (FWHM).

The challenging technical difficulties of this project are:

- The quality of the optical elements (in particular the slope errors requirements of the polychromator and of mirror M2);
- The implementation of mirror M2, the polychromator, mirror M3 and the sample environment in a reduced space;
- The implementation of mirror M1 close to the first optical elements of project EDXAS-L;
- The contributions to the focal spot size have to be estimated in the Bragg and Laue cases for the dynamical diffraction effects on the polychromator.
- The understanding of the origin of crystal polychromator degradation, occurring (and visible) mainly at low energies and apparently catalysed by interaction with intense photon beams;
- The efficient cooling of all optical elements.

EDXAS-L

An undulator X-ray source both on a high or on a low beta straight section leads inevitably to a high demagnification factor since the source must be coupled to a horizontally focusing mirror to enhance the horizontal divergence up to 1 mrad. Starting from an undulator source, it is therefore not possible to obtain a "large" focal spot for EDXAS-L. Two solutions can be envisaged: (i) a wiggler with an intermediate k parameter of about 5.5 or (ii) a bending magnet. As one of the main scientific goals is to perform fast time-resolved XAS experiments on non-reversible processes in the ms range and below, the flux per energy bandpass unit is a key parameter. For a given vertical acceptance and 1 mrad of horizontal acceptance, the ratio in flux between a bending magnet and a 70 mm period wiggler in a canted high beta sector is of the order of 1:90. Taking into account the present performance of ID24, we

estimate that the millisecond regime on non-reversible phenomena is attainable only with the use of a wiggler source.

As the natural horizontal divergence of such a source well matches the requirements of EDXAS, no additional horizontal mirror is required. Instead a double vertical mirror system will be installed (i) to reach the required harmonic rejection level compatible with EXAFS, (ii) to collimate the vertical divergence of the beam and (iii) to decrease heat load on the polychromator. This set of mirrors has to be positioned as close as possible to the source to optimise the size of the mirror (transversal and longitudinal) and the vertical acceptance at the same time.

For such a project the main technical challenge will be the heat load problem on the optical elements, especially on the polychromator. To reduce heat load on this element, for each absorption edge a specific energy bandpass will be selected upstream the polychromator, combining attenuators and choice of mirror coating and grazing angle. In any case, a complete redesign of the polychromator and its cooling system is required.

The EDXAS-L energy dispersive spectrometer with its sample environment has to be installed either before or after the EDXAS-S station. With buildings constraints, two slots are possible with either a polychromator at 90 m or at 45 m. The principal interests of the solution at 90 m are the reduction of the heat load density on the polychromator and a larger energy bandpass at low energies (1 keV at the Fe-K edge, instead of 700 eV). A second major advantage is that a focal distance of 1.5 m is possible without compromise on the diffracted energy bandwidth, leaving sufficient space for the installation of complementary techniques synchronized to the EXAFS acquisition, such as IR, Raman and UV-Vis spectrometers.

The challenging technical difficulties of this project are:

- The heat load on the double vertical mirrors and on the polychromator.
- The design and the implementation of the double vertical mirror as close as possible to the source.
- As above, the understanding of the origin of crystal polychromator degradation, occurring (and visible) mainly at low energies and apparently catalysed by interaction with intense photon beams.
- The development of a suitable and faster detector for time-resolved EDXAS.

Support facilities

We propose that the activities carried out on EDXAS-L should continue to profit from the synergy with the

present ID26 so that these two beamlines would benefit from common chemistry support facilities and *in situ* characterisation methods (UV-Vis, IR, Raman spectrometers).

The experimental station on EDXAS-S will include a laser heating facility for studies in DACs, similar to that installed on the present ID27. A high pressure laboratory close to the beamline, gas charging facilities for DACs as well as access to micromanipulation equipment, shared eventually with projects XMAN and SMILE, will be required. Strong support from the Optics Group is needed for the different issues detailed in 1.4 above.

References

- Bonfim M., Mackay K., Pizzini S., Arnou M.-L., Fontaine A., Ghiringhelli G., Pascarelli S., and Neisius T. (2000), Nanosecond resolved techniques for dynamical magnetization reversal measurements, *J. Appl. Phys.*, **87**, 5974-5976.
- Bouhifd M.D., Gautron L., Bolfan-Casanova N., Malavergne V., Hammouda T., and Jephcoat A.P. (2006), Partitioning of potassium between silicate and Fe-alloy liquids at high pressures: Implications for the Earth's core, *Earth Planet. Sci. Lett.*, in press.
- Dubrovinsky L., Dubrovinskaia N., Langenhorst F., Dobson D., Rubie D., Geßman C., Abrikosov I., and Johansson B. (2003), Iron-Silica Interaction at Extreme Conditions and the Nature of the Electrically Conducting Layer at the base of Earth's Mantle, *Nature*, **422**, 58-61.
- Fernández-García M., Martínez-Arias A., Hanson J.C., and Rodríguez J.A., (2004), Nanostructured Oxides in Chemistry: Characterization and Properties, *Chem. Rev.*, **104**, 4063-4104.
- Frost D. (2003), The structure and sharpness of (Mg,Fe)SiO phase transformation in the transition zone, *Earth Planet. Sci. Lett.*, **216**, 313-328.
- Frost D., Liebske C., Langenhorst F., McCammon C., Trønnes R.G., and Rubie C. (2004), Experimental evidence for the existence of iron-rich in metal in the Earth's lower mantle, *Nature*, **428**, 409-412.
- Grunwaldt J.D. and Baiker A. (2005), *in situ* spectroscopic investigation of heterogeneous catalysts and reaction media at high pressure, *Phys. Chem. Chem. Phys.*, **7**, 3526-3539.
- Guilera G., Newton M.A., Polli C., Pascarelli S., Guinó M., and King Kuok (Mimi) Hii (2006), *In situ* investigation of the oxidative addition in Homogenous Pd catalysts by synchronized time resolved UV-Vis/EXAFS, *Chem. Commun.*, **41**, 4303-4305.
- McCammon C. (2005), The Paradox of Mantle Redox, *Science*, **308**, 807-808.
- Munoz M., De Andrade V., Vidal O., Lwein E., Pascarelli S., and Susini J. (2006), Redox and speciation micro-mapping using dispersive X-ray absorption spectroscopy: Application to iron in chlorite mineral of a metamorphic rock thin section, *Geochem. Geophys. Geosyst.*, **7**, Q11020.
- Newton M.A., Dent A.J., Fiddy S.G., Jyoti B., and Evans J. (2007), Identification of the surface species responsible for the NO formation from the chemisorption of NO on Rh/alumina, *Phys. Chem. Chem. Phys.*, **9**, 246-249.
- Pascarelli S., Mathon O., Munoz M., Mairs T., and Susini J. (2006), Energy Dispersive Absorption Spectroscopy for hard X-ray micro-XAS applications, *J. Sync. Rad.*, **13**, 351-358.
- Pascarelli S., Neisius T., and De Panfilis S. (1999), Turbo XAS: Dispersive XAS using Sequential Acquisition, *J. Sync. Rad.*, **6**, 1044-1050.
- Pascarelli S., Ruffon M., Pettifer R., Staunton J., and Mathon O. (2006), X-ray absorption spectroscopy to investigate magnetostriction on an atomic scale, 21st Workshop on Novel Materials and Superconductors, Planneralp, Austria.
- Pettifer R., Mathon O., Pascarelli S., Cooke M., and Gibbs M. (2005), Measurements of femtometre-scale atomic displacements by X-ray absorption spectroscopy, *Nature*, **435**, 78-81.
- Vidal O., De Andrade V., Lewin E., Munoz M., Parra T., and Pascarelli S. (2006), P-T-deformation-Fe³⁺/Fe²⁺ mapping at the thin section scale and comparison with XANES mapping. Application to a garnet-bearing metapelite from the Sambagawa metamorphic belt (Japan), *J. Metamorphic Geol.*, **24**, 669-683.
- Wood B., Walter M., and Wade J. (2006), Accretion of the Earth and segregation of its core, *Nature*, **441**, 825-833.

EXAFS: Extended X-ray Absorption Fine Structure Spectroscopy

Summary

In the portfolio of the ESRF public beamlines we propose to maintain a standard bending magnet EXAFS beamline optimised for transmission EXAFS and simultaneous angle resolved X-ray diffraction (XRD), operational in a large energy range covering the K-absorption edges from calcium (4 keV) to uranium (115 keV). This instrument aims at meeting the needs of the member countries in the area of conventional XAS for experiments which have requirements that fall beyond the capabilities of most other similar beamlines at lower energy synchrotron sources, *i.e.* photon energies above ~ 40 keV. This beamline would complement the low energy spectroscopy beamlines ID08 (CDR RIXS-PES) and ID21 (CDR SMILE), the microspectroscopy (ID22, CDR XMAN), high resolution (ID26, CDR XAS-XES) and energy dispersive (ID24, CDR EDXAS) beamlines and thus allow the ESRF to offer the complete spectrum of X-ray absorption spectroscopy techniques, an offer unequalled throughout Europe.

The beamline is designed to be general purpose and open to a very wide community of users in many different fields. Its assets are an excellent signal-to-noise ratio, stability, versatility, reliability and high automation level, coupled with *in situ* XRD on the same sample under identical thermodynamic conditions.

A standard EXAFS beamline on a bending magnet source is also an indispensable and necessary tool to complement and to increase the efficiency of cutting edge experiments scheduled on insertion device (ID) sources. Beamlines such as the present ID21, ID22, ID24 and ID26 all benefit from having the possibility of using the ESRF public bending magnet EXAFS beamline in rapid access mode for complementary standard sample measurements that do not require highly brilliant X-ray beams.

Scientific case

The scientific case for a general purpose EXAFS and angle resolved X-ray diffraction (AR-XRD) beamline is very wide, as shown by the varied and high quality scientific output of BM29. Below, we list a few selected applications that fall within the emerging scientific fields highlighted in the ESRF Upgrade Programme, namely "science at extreme conditions" (Part A) and that which concerns the investigation of materials for the future with remarkable properties (Part B).

A. Science at extreme conditions

Icosahedral order in liquid metals: Local ordering in liquid condensed phases can show signatures of five fold symmetry forbidden in crystals, but current experimental knowledge of liquids is limited to pair distribution, leaving considerable uncertainty in the determination of the local geometrical structure. The presence of this particular type of local symmetry can be studied by taking advantage of experimental techniques like X-ray absorption spectroscopy (XAS) sensitive to local higher order correlations through multiple scattering (MS) of the photoexcited electron from a core level. Novel X-ray absorption experimental results on liquid and undercooled liquid copper (Di Cicco *et al.*, 2003) interpreted using an advanced data analysis method based on multiple scattering simulations, have been shown to contain direct information on triplet correlations making feasible a reliable determination of the bond angle distribution and fraction of icosahedral configurations in liquids.

Aqueous Solutions: The properties of aqueous solutions under pressure are fundamentally important for a number of scientific disciplines, including the study of the physicochemical properties of water in

the Earth's mantle or icy satellites and the understanding of the pressure effects in many chemical and biological processes. The pressure dependence of the radial distribution function of water molecules in an aqueous solution of RbBr was investigated around both Br⁺ and Rb⁻ ions (Filipponi *et al.*, 2003). Dramatic effects were observed in the anion hydration structure around 0.5 to 1 GPa indicating that, upon increasing pressure, water undergoes a structural transformation that involves considerable molecular reorientation.

Alkali doped fullerenes: Covalent bonding of C₆₀ molecules gives rise to 1D-, 2D- and 3D-polymerisation at high pressures and high temperatures, with carbon hybridisation changing from sp² to sp³. A number of works report super hard 3D polymerised phases and many fullerene derived solid phases have been synthesised with novel properties and potential applications. Alkali metal intercalation compounds have drawn most of the attention, mainly because of the occurrence of superconductivity at relatively high temperatures (Connétable *et al.*, 2003). Investigation of the evolution with pressure and temperature of different alkali doped fullerenes, allowing for the formation of new metallic polymeric forms with covalent interlinking between the C₆₀ molecules, is ideally suited to an instrument combining EXAFS and XRD in a large energy range. Local electronic and/or structural modifications around the alkali atom are readily detected through XANES/EXAFS and correlated to long range structural rearrangements through XRD (Poloni, 2007). For such investigations, it is of utmost importance to be able to record XAS and XRD in identical thermodynamic conditions.

B. Materials for the future with remarkable properties

Magnetism of nanoparticles: Metallic nanoparticles are studied extensively since they exhibit novel electronic, optical and magnetic properties, mainly related to the "size effect" which affects the electronic structure, as well as to the increase of the surface to volume ratio. In gold nanoparticles, an enhancement of "d-d" electron interactions and a decrease in the number of "d" holes with respect to that of bulk have been observed and are known to be counterbalanced when the gold nanoparticles are capped with strong interacting thiols. It is then possible to tune the number of "d" holes (*i.e.* the magnetic behaviour) by combining size-effect and thiol-capping in gold nanoparticles. These conclusions were reported by a XAS study on BM29 (Crespo *et al.*, 2004) and magnetisation measurements also showing that very small thiol-capped gold nanoparticles exhibit a localised permanent magnetism in contrast to the metallic diamagnetic character of gold nanoparticles covered with surfactant molecules.

Negative and Zero Thermal Expansion materials:

A detailed understanding of the microscopic mechanisms responsible for macroscopic negative thermal expansion (NTE) has not yet been obtained and represents a challenging topic of basic research. It is in any case well known that NTE is connected to vibrations perpendicular to some inter-atomic bonds. XAS and XRD give different and complementary information on thermal expansion and atomic vibrations. In particular, XAS can measure the thermal expansion of selected bond distances and, by comparison with XRD, the amplitude of relative vibrations perpendicular to the bonds. This kind of information is of particular relevance for clarifying the mechanism of NTE. The effectiveness of a joint XAS-XRD approach has been demonstrated by recent work (Sanson *et al.*, 2006) on the cuprites Cu_2O and Ag_2O , where it has been possible to find evidence of a peculiarly complex local dynamical behaviour. A recent work on ReO_3 has shown that sub-picometre accuracy is now attainable by XAS on BM29.

Isotopic effects: Very recently XAS measurements on the isotopes 70 and 76 of germanium as a function of temperature on BM29 have shown the possibility of measuring distance differences of the order of 0.0001 Å in a standard transmission experiment, and thereby directly monitoring the low temperature isotopic quantum effect on thermal expansion by means of XAS.

The results obtained in both NTE and isotopic effect studies open new research fields for XAS and show that high quality basic research can still be performed on standard beamlines. A fundamental question is whether the same degree of spectral stability and reproducibility, flexibility of optical settings and sample conditioning, as well as the possibility of performing simultaneous XAS and XRD measurements - required by this kind of studies - can still be guaranteed by non standard beamlines.

Metal Organic Frameworks (MOFs): The hybrid architecture of MOFs opens the possibility to design and synthesise a great variety of new porous materials, which are in principle able to display novel functionalities that are potentially exploitable for a number of applications such as gas storage, nonlinear optics, ion exchange and catalysis. In this field, the determination of the coordination and of the oxidation state of the metal atoms hosted in these materials is of major importance. For these studies, the stability of the optics of the present beamline is mandatory as it makes it possible to collect EXAFS data with good accuracy *in situ* and *in operando* conditions. The high quality measurements already collected on BM29 have shown recently that only the EXAFS could make it possible to give a dynamical view of the interaction of reagent with the metal sites. This data has elucidated the coordination variations

around the metal centre induced by interaction with molecules, and consequently justified the ability of some materials to act or not for the forecast functions (Prestipino *et al.*, 2006; Szeto *et al.*, 2007).

Techniques**EXAFS and XANES**

X-ray absorption spectroscopy is a unique probe to determine the local structure, electronic and vibrational properties of a material. The beamline would be optimised to record XAS spectra in transmission geometry using ionisation chambers. As options, fluorescence detection using germanium multi-element detectors, photodiodes or crystal analysers would also be available to give the total electron yield.

Angle Resolved X-ray Diffraction

An image plate MAR detector off the main beam axis would be available allowing the combination of XAS and AR-XRD information. In addition, a vertical diffractometer would be available for rapid access sample characterisation by AR-XRD.

Context with new sources and user community

Within the European context, we note that every synchrotron source, operating or under construction, has or will have at least one beamline dedicated to hard X-ray absorption spectroscopy (on bending magnets, wigglers or undulators). In general, the optical scheme consists of a vertical collimating mirror, a double crystal monochromator and refocusing optics. The covered energy range typically falls within 2 to 25 keV. Only in a few cases it extends up to 40 keV.

With a general purpose beamline dedicated to EXAFS spectroscopy and X-ray diffraction, oriented towards high quality data collection, automation, online data analysis and flexible sample environments, the ESRF would be in the position to propose a coherent strategy for X-ray absorption spectroscopy in Europe. In this context, the bending magnet beamline, optimised for EXAFS in transmission geometry in a large energy range (4 to 120 keV) and, at the same time, acting as a user/in-house EXAFS/XRD rapid access facility for sample characterisation, would be complemented by a solid platform of specialised beamlines described elsewhere in the Upgrade Programme.

Technical considerations

This beamline would be designed to perform XAS with an excellent signal-to-noise ratio, stability, versatility, reliability and high automation level. To preserve these standards, the optical scheme will remain relatively simple and similar to the present BM29, which we briefly describe in the following paragraph.

The first optical element is a double crystal, fixed exit, double cam type monochromator manufactured by Kohzu (Japan). The two crystals are in (+,-) geometry and diffract in the vertical plane. An angular range between 4.5 and 45 degrees is accessible. Crystals typically used on BM29 include Si(111), Si(311), and Si(511), but higher indexes can be envisaged to extend the present energy range (4 to 75 keV). We propose to permanently install these three pairs of crystals inside the monochromator and couple them with a precise horizontal transverse translation. Furthermore, we propose an upgrade to the present monochromator cooling scheme from a closed loop, cryogenic helium gas circuit to a liquid nitrogen circulator in order to preserve optimal operation conditions at high energies.

Downstream of the monochromator a pair of flat mirrors rejects harmonics. The angle of incidence is variable between 2 and 5 mrad, and three reflecting stripes (Si, Pt, Rh) can be selected to cover the large operational energy range from 4 to 40 keV. The height of the beam reflected by the double mirror system is independent of incidence angle. Vertical focusing is achieved by meridionally cylindrically bending the second mirror with radius of curvature continuously variable between 2 km and ∞ . A vertical focal spot size between 40 and 60 μm FWHM is obtained.

Future upgrades of the optics are envisaged. In particular we plan to collect a larger horizontal fan of radiation, now limited to the size of the sample (about 0.025 mrad for a 1 mm sample). One of the most attractive solutions would consist of installing as a final optical element a set of modular graded multilayers for horizontal focusing, collecting 0.15 mrad and focusing them into a $\sim 50 \mu\text{m}$ spot. If the beamline is to be rebuilt on a different synchrotron port, we would furthermore add a vertical collimating system upstream of the monochromator.

The experimental station would also remain similar to the present one, which consists of a single bench, mounted on a penta-pod, hosting multipurpose sample environments. Three ionisation chambers (I0, I1 and I2) are permanently installed as well as two sample sticks for ambient temperature and reference sample measurements respectively. The beamline is

equipped with various sample environments:

- A He flow cryostat (1.8 K up to 400 K);
- Furnaces (up to 3000 K);
- High pressure cells for studies at extreme conditions (up to 15 GPa and 2300 K).

Besides the standard transmission mode, EXAFS can be detected in total fluorescence and/or total electron yield. The BM29 experimental setup is completed by the option of collecting complementary X-ray diffraction patterns through an image plate MAR detector mounted off the beam axis.

As an upgrade for the future, we propose to transform the RefLEXAFS station into a high resolution angle resolved X-ray diffraction (AR-XRD) rapid access facility for the user community. The three-circle Huber goniometer already available on the beamline will be equipped for powder diffraction (Fitch, 1995).

References

- Connétable D., Timoshevskii V., Masenelli B., Beille J., Marcus J., Barbara B., Saitta A. M., Rignanese G. M., Mélinon P., Yamanaka P., and Blase X. (2003), Superconductivity in Doped sp^3 Semiconductors: The Case of the Clathrates, *Phys. Rev. Lett.*, **91**, 247001.
- Crespo P., Litran R., Rojas T.C., Multigner M., de la Fuente J.M., Sanchez-Lopez J. C., Garcia M.A, Hernando A., Penades S., and Fernandez A. (2004), Permanent Magnetism, Magnetic Anisotropy, and Hysteresis of Thiol-Capped Gold Nanoparticles, *Phys. Rev. Lett.*, **93**, 087204.
- Di Cicco A., Trapananti A., Faggioni S., and Filippini A. (2003), Is There Icosahedral Ordering in Liquid and Undercooled Metals?, *Phys. Rev. Lett.*, **91**, 135505.
- Filippini A., De Panfilis S., Oliva C., Ricci M.-A., D'Angelo P., and Bowron D.T. (2003), Ion Hydration under Pressure, *Phys. Rev. Lett.*, **91**, 165505.
- Fitch A.N. (1995), High resolution powder diffraction studies of polycrystalline materials, *Nucl. Inst. Meth. Phys. Res. B*, **97**, 63-69.
- Poloni R., (2007) PhD Thesis, ESRF, Grenoble: Alkali metal doped fullerenes under extreme conditions.
- Prestipino C., Regli L., Vitillo J.G., Bonino F., Damin A., Lamberti C., Zecchina A., Solari P.L., Kongshaug K.O., and Bordiga S. (2006), Local structure of framework Cu(II) in HKUST-1 metallorganic framework: Spectroscopic characterization upon activation and interaction with adsorbates, *Chem. Mater.*, **18**, 1337-1346.
- Sanson A., Rocca F., Dalba G., Fornasini P., Grisenti R., Dapiaggi M., and Artioli G. (2006), Negative thermal expansion and local dynamics in Cu_2O and Ag_2O , *Phys. Rev. B*, **73**, 214305.
- Szeto K.C., Prestipino C., Lamberti C., Zecchina A., Bordiga S., Bjrger M., Tilset M., and Lillerud K.P. (2007), Characterization of New Porous Pt-Containing Metal-Organic Framework, containing potentially catalytically active site: Local Electronic Structure at the Metal Centers, *Chem. Mater.*, **19**, 211-220.

MAGSCAT: Magnetic Scattering

Summary

With this project we propose to upgrade the ID20 magnetic scattering beamline and extend the experimental conditions in order to provide new research opportunities for the benefit of a wide user community. Key objectives of the project are to:

- Provide an upgraded instrument with a stable and focused photon beam for resonant X-ray scattering (RXS) and photon polarisation analysis in the energy range 2.5 to 30 keV.
- Build a dedicated station for very low temperatures (below 1 K), high magnetic fields (superconducting split-coil magnets up to 17 T) and high pressure (up to 5 GPa at 1.5 K).
- Build an extended station for very high DC magnetic fields, operating a hybrid split-coil magnet up to 30 T for RXS.

The research field of RXS has experienced tremendous theoretical and experimental progress over the last few years and is one of the most important areas of investigation in modern synchrotron radiation sources. This method uses the photon beam as a quantum probe to investigate structural, magnetic and electronic ordered structures of condensed matter. It represents a meeting point between the theoretical understanding of photon interaction with bound electrons in condensed matter and the exploitation of the main characteristics of a third-generation synchrotron beam: light polarisation control and analysis (linear and circular), fine energy tuning, focusing, high flux and (not the least) beam stability.

The main objective of this project is to develop a new instrument for studies of electronic and magnetic quantum phase transitions in condensed matter physics, by developing the instrumentation in the domain of low temperatures combined with experiments under high magnetic field and high pressure. This is a natural evolution of the present experimental setup of ID20 and takes into account the new advances in experimental and theoretical understanding of the RXS technique, which provides unique and complementary information compared to the neutron scattering in the field of the physics of strongly correlated electron systems.

Although specialised and optimised for near edge resonant magnetic diffraction studies of transition metals (K), lanthanides (L), and actinides (L and M), ID20 has broad and highly optimised capabilities for a wide range of different scientific problems related to the physics of condensed matter, for example, studies of surface magnetism, of magnetic thin films and

heterostructures, and of local dynamical fluctuations by photon correlation spectroscopy, which benefit from the present experimental setup.

Scientific case

Overview

The fundamental interaction of X-rays with bound electrons can be due to the electrons charge or by the coupling between the electric and magnetic field of the incident photons with the atomic magnetic moment. Charge scattering is the dominant mechanism and the basis for crystallographic investigation of condensed matter. X-ray magnetic scattering gives rise to two regimes, determined by the incident photon energy: the non-resonant limit (NRXMS), in which the incident X-ray energy is well separated from the excitation energy of any atomic absorption edge in solids and includes X-ray energies up to 100 keV and the RXS regime, where the incident X-ray energy lies near an absorption edge. The scattering amplitudes between the magnetic and charge scattering events vary by several orders of magnitude (about 10^{-6}) and the detection of the weak magnetic signal requires the high photon flux delivered by undulator beamlines at third-generation synchrotron radiation sources.

RXS combines high-Q resolution X-ray diffraction with atomic spectroscopy for investigating the subtleties of microscopic electronic and magnetic interactions in systems where the ground state properties reflect a delicate balance between several different correlated processes. In the resonant regime, when the incident X-ray energy is tuned across an absorption edge, there are additional contributions to the X-ray scattering cross-section which are due to the injection of a core level electron into a partially filled valence band shell, which subsequently decays through the emission of an elastically scattered photon with particular polarisation dependence. The special nature of this process is that it is both electron shell and element specific, and it has introduced species sensitivity directly into the determination of magnetic structures (Gibbs, 2001).

Over the last few years, the possibility of singling out structural, magnetic and anomalous scattering components through Bragg diffraction, and to study the polarisation dependence of the diffracted beam as a function of scattering angle and incident photon energy, have provided a large amount of experimental data, that, in turn, have stimulated theoretical calculations and interpretations. In particular, the separation of the signal in terms of electromagnetic multipoles is, at present, one of the most fashionable ways to classify these experiments and to open new avenues in this research field (Marri and Carra, 2004;

Di Matteo *et al.*, 2005). The knowledge of electric and magnetic multipoles of both parities under space-inversion and time-reversal can be of great importance in order to understand the physics of strongly correlated electron systems. In the light of this interpretation, the RXS technique can be applied to the investigation of many complex materials, such as Mott insulators, colossal magnetoresistive materials, actinides, high- T_c superconductors, multiferroics, heavy fermions and other transition metal oxides, in which orbital or multi-polar hidden order parameters coexist and influence the phase transitions (Paolasini *et al.*, 1999; Paixao *et al.*, 2002; Wilkins *et al.*, 2006; Walker *et al.*, 2006). Strong multipolar interactions can lead to exotic states such as quadrupole fluctuations mediated superconductivity, or novel heavy Fermion states when quadrupolar order is suppressed by an external magnetic field. Interesting physics can also be addressed in multi-k antiferromagnets in which quadrupolar and magneto-vibrational interactions are far from negligible. More systematic information is required for a theoretical understanding of the atomic multiplet configuration interaction aspects and the band structure like effects, which play important and often competing roles in correlated systems.

Future developments in RXS will provide new powerful tools for investigating quantum phase transitions and the peculiar electronic behaviour of strongly correlated electron systems. In fact, the fragile equilibrium between competing electronic interactions in these complex materials can be altered by applying pressure, or a sufficiently strong external magnetic field at very low temperature (below 1 K), where the thermal fluctuations are reduced compared to the quantum fluctuations.

The observation and characterisation in terms of the ordering of discrete multipoles today places ID20 at the forefront of basic research on magnetism and the availability of RXS at extreme conditions is important for progress to be achieved.

Techniques

RXS and the Full Polarisation Analysis

The core activity of the beamline consists of measuring in diffraction conditions and close to the absorption edges forbidden lattice reflections appearing as a consequence of broken lattice symmetries (magnetic, charge or multipolar), and characterise them in terms of light polarisation, angular dependence about the scattering vector (azimuthal dependence) and energy dependence across the absorption edge. The azimuthal dependence is one method that directly measures the tensors and involves measuring the diffracted X-ray linear polarisation upon rotating the sample around

the scattering vector. This technique has been essential in a number of high profile cases and has opened a new method of studying the physics of multipole ordered states (ID20, 2006). The possibility of controlling the incident beam polarisation by diamond phase plates and analysing the polarisation of the scattered photons as a function of the azimuthal scattering geometry and the incident energy should play an important role in the future of this technique, providing a way to obtain information on the symmetry of the ordered structure (charge, magnetic or multipolar) (Mazzoli *et al.*, 2006). Future plans of development concern the design of a dedicated azimuthal diffractometer with a vertical scattering geometry for azimuthal scans (open χ -circle), combined with a ^4He flux cryostat and high cooling power (40 mW at basic temperature of 1.5K). The diffractometer will be placed in a dedicated experimental hutch EH1 closest to the focusing optics and which include the elements for beam conditioning (diamond phase plates, attenuators, beam monitoring).

RXS under extreme conditions

Compelling scientific problems in contemporary condensed matter physics and material science make the development of combined experiments (under applied magnetic fields (H), electric fields (E), and high pressures (P) at lowest temperatures (T)) critical to enable major scientific breakthroughs.

The objective of this proposal is to develop two dedicated stations for RXS under extreme conditions:

1. an experimental hutch EH2 with a heavy load six-circle diffractometer holding a superconducting split coil magnet (10 T magnet already in use at ID20) in which these combined experiments (H-E-T-P) can be performed and developed;
2. a state-of-art, highest steady state magnet (30 T) built with series connected hybrid technology and placed downstream the EH2 close to the common power supply near the ILL site.

The first station is under development at ID20 and the optimisation of beam stability and focusing in the new beamline will allow more systematic studies of magnetic phase transitions, providing new research capabilities as well as building up expertise to lead to further technological advances in this technique. The second station is one of the most attractive opportunities to carry out cutting edge high field science in the 21st century. This project will enable multidisciplinary activities in condensed matter research and the application of unprecedented magnetic field strength with the various powerful X-ray scattering techniques will lead to new scientific discoveries. It is important for this purpose to design a beamline with the largest versatility and flexibility in term of insertion devices, optic focusing elements

and energy range (highest energies may be required to perform non-resonant magnetic X-ray scattering, powder diffraction or other diffraction studies).

Context with new sources and user community

Started at Brookhaven in 1988, the subject of RXS is growing, and work is now in progress at the ESRF (on a number of beamlines, ID20, XmaS, ID08), KEK-Tsukuba (Japan), SPRING-8 (Japan), ALS (Berkeley, US), APS (Argonne, US), BESSY-II (Germany), SLS (Switzerland), Postech and PAL (Korea), Campinas (Brazil). Each of these sources features beamlines specialised for X-ray magnetic scattering studies (Gibbs, 2001). Beamlines adapted for RMXS are also in construction at DIAMOND and SOLEIL. The working energy range for RXS is certainly well adapted (in term of brilliance) for the new third-generation national sources (SOLEIL-France, PETRA-III-Germany, DIAMOND-UK, and ALBA-Spain). In other words the present Upgrade Programme requires local support, infrastructures, local scientific and technical expertise, which are important factors and strengths of the ESRF.

Technical considerations

The main technical considerations for the realisation of this project are:

1. The design of the UHV optics, which allows the beam to be focused independently into three separate experimental stations, with an energy range of 2.5 to 30 keV and a possible extension over 50 to 100 keV for NRXMS studies.
2. The design of two main experimental stations for RXS similar to the existing ID20 experimental hutches EH1 (for full polarisation analysis and azimuthal scattering geometry) and EH2 (for RXS under extreme conditions).
3. The design of a custom experimental stations EH3 for a dedicated very high DC hybrid connected 30 T split pair magnet.

The main project proposed consists of the construction of two optics hutches, OH1 for the monochromator and high power white mirror and OH2 for focusing optics and high harmonic rejection mirrors. It is possible to build a third optics hutch OH3 close to the high DC 30 T magnetic station, in order to improve the necessary stability and focusing close to the external experimental hutch. The objectives are the following:

- Front-end upgrade and high power heat load on the first optical elements;
- Beam stability in term of flux and positioning (low counting rates);

- Focusing performance (different focal points due to the three in-line stations);
- Small spot size (increasing demagnification factors);
- Diagnostics, monitoring and characterisation of different optic elements;
- UHV optics with removable Be-windows.

Cryogenic devices and superconducting split-pair top-loading magnets will require a very high experimental hutch for sample stick insertion and large volumes for containing the helium and nitrogen gases released during a possible magnet quenching. Moreover, lateral large dimensions of the hutch are needed to prevent the coupling of walls with the magnetic stray field produced by superconducting magnets (minimal distance of 3 m). In general the sample environment for RXS requires demanding technical solutions due to the strong photon absorption of materials in the energy range between 2.5 and 10 keV, wide scattering access for the X-ray beam, and custom instrumentation. Beryllium windows are today available and extensively used in all the cryogenic devices at ID20.

It is important at this stage to summarise the possible technical development in the different domains of interest:

Magnetic fields: The magnet technology based on a split coil design for vertical field magnets is the most suitable for diffraction experiments because it offers the largest optical access for scattering studies and top loading access for samples. The top-loading geometry in turn allows diverse variable temperature insert and sample insert devices (electric field stick, high pressure stick) and devices to rotate the sample in different directions with respect to the applied magnetic field to be used during combined H-E-P-T experiments.

Today two major developments in magnet technology are foreseen:

- Superconducting split-coil magnets (SSCM) are commonly used in neutron scattering techniques and they can reach magnetic fields of the order of 15 T. The SSCM are more versatile, user friendly and are adapted for routine experiments based on the user programme. Future possible upgrades of the high magnetic field station concern the design of a new SSCM which can reach 17 T with similar characteristics of the actual 10 T magnet in term of small absorption and wide scattering angles, but with a reduced splitting between the coils (X-ray access of 2 mm) and the cold bore diameter down or reduced to 15 mm.
- High magnetic fields based on series connected hybrid magnet (SCHM) technology can deliver steady magnetic field above 45 T. In the case of split coil geometries 30 T is today the maximum limit for a SCHM. The implementation of such devices in the domain of synchrotron radiation is new and requires a

synergy between different specialised capabilities. The SCHM is a large facility, requiring specialised manpower both for operation and maintenance. The design study of the power station, the power connections and the infrastructure building have to be planned by taking into account the specific requirements of the beamline station where the SSCM will be placed.

High Electric Fields: The application to the sample of an electric field, E , of the order of 20 kV/cm during a RXS measurement is technically challenging because of discharge problems. In fact the cooled samples must be isolated by the helium exchange gas, extremely ionisable at low pressure. In the near future we plan to realise a custom sample stick to exploit the possibility of *in situ* application of an electric field to the sample. This will give us the unique chance of applying both magnetic and electric fields at the same time, providing us with the perfect environment to study, for example, multiferroic materials characterised by a direct interplay between the electric and magnetic degrees of freedom.

Low Temperatures: In the domain of low temperatures, the design of a custom cryogenic system capable of reaching temperatures below 1 K is limited by the incident photon flux on the sample. The strong absorption of the sample surface around the characteristic working energies deeply affects the thermal behaviour of measured materials, and the attenuation of the beam is often necessary to attain the transition temperature. The cooling power required for RXMS at low temperatures is of the order of 40 mW, and a ^3He system is the most suitable to reach the desired performances. The exploration of a possible cryogenic device able to fulfil these requirements is certainly a technical challenge and an important issue for RXMS studies.

High Pressure: The application of high pressure at low temperatures on strongly correlated electron systems leads to variations manifested in the electronic structure, because of the change of the degree of overlap of exchange integrals between interacting atoms, and therefore the amount of competing magnetic and electronic interactions responsible for anomalous low temperature thermodynamic and transport properties. RXS is an ideal technique to be combined with hydrostatic pressure, and being able to determine structural and electronic order parameters as a function of bonding lengths. The aim of the project is to develop a method to probe a phase diagram between 0 to 5 GPa and 1.5 to 300 K with *in situ* pressure and temperature variation and detection for incident X-rays tuned to the absorption edges of transition metals and lanthanide elements (Kernavanois *et al.*, 2005).

Support facilities

- Sample preparation laboratory for single crystal orientation and cutting.
- Cryogenic laboratory.

These facilities will be used extensively and are of vital importance for the beamline operation, in particular for the new sophisticated sample environments demanding precise sample orientation.

References

- Di Matteo S., Joly Y., and Natoli C.R. (2005), Detection of electromagnetic multipoles by x-ray spectroscopies, *Phys. Rev. B*, **72**, 144406.
- Gibbs D. (2001), X-ray magnetic scattering, *Synchrotron Radiation News*, **14**, 4-10.
- ID20 (2006), Activity Report for Beamline ID20, ID20 beamline review, May 16-17 2006.
- Kernavanois N., Deen P., Braithwaite D., and Paolasini L. (2005), Pressure device for resonant magnetic x-ray scattering, *Rev. Scient. Instr.*, **71**, 083909.
- Marri I. and Carra P. (2004), Scattering operators for E1-E2 x-ray resonant diffraction, *Phys. Rev. B*, **69**, 113101.
- Mazzoli C., Wilkins S.B., Di Matteo S., Detlefs B., Detlefs C., Scagnoli V., Paolasini L., and Ghigna P. (2007), Disentangling multipole resonances through a full x-ray polarization analysis, *Phys. Rev. B*, in press.
- Paixao J.A., Detlefs C., Longfield, Caciuffo R., Santini P., Bernhoeft N., Rebizant J., and Lander G.H. (2002), Triple- $q \rightarrow$ Octupolar Ordering in NpO_2 , *Phys. Rev. Lett.*, **89**, 187202.
- Paolasini L., Vettier C., de Bergevin F., Yakhov F., Mannix D., Stunault A., Neubeck W., Altarelli M., Fabrizio M., Metcalf P.A., and Honig J.M. (1999), Orbital Occupancy Order in V_2O_3 : Resonant X-Ray Scattering Results, *Phys. Rev. Lett.*, **82**, 4719-4722.
- Walker H.C., McEwen K.A., McMorrow D.F., Wilkins S.B., Wastin F., Colineau E., and Fort D. (2006), Determination of the Antiferroquadrupolar Order Parameters in UPd_3 , *Phys. Rev. Letters*, **97**, 137203.
- Wilkins S.B., Caciuffo R., Detlefs C., Rebizant J., Colineau E., Wastin F., and Lander G.H. (2006), Direct observation of electric-quadrupolar order in UO_2 , *Phys. Rev. B*, **73**, 060406R.

PMF: Pulsed Magnetic Fields

Summary

The proposed experimental station will be dedicated to X-ray diffraction and absorption spectroscopy under pulsed magnetic fields in the range of 30 to 50 T. It will be an evolution of the transportable pulsed magnetic field project previously employed on BM26B (see Frings *et al.*, 2006), ID20 and ID24, and

which will be exploited on ID06 (currently under construction).

The beamline will offer a variety of X-ray techniques, in particular powder diffraction, single crystal diffraction (including X-ray resonant scattering, XRS) and absorption spectroscopy (including X-ray magnetic circular dichroism, XMCD) over a photon energy range from 5 to 100 keV. While, in principle, magnetic fields affect all kinds of matter, we here focus on the field of correlated electron physics, in particular field induced phase transitions.

An experimental station dedicated to pulsed magnetic fields could be realised within a relatively short timescale and with a modest budget. It would thus help to explore the wider scientific case for steady (DC) high magnetic fields beyond those currently realisable with superconducting cryomagnets and seed the user community for such an installation.

Scientific case

Overview

The magnetic field is a thermodynamic parameter of fundamental importance, on equal footing with temperature and hydrostatic pressure. As all electrons carry a spin, all types of matter can be influenced by the application of external magnetic fields. Here, however, we will focus on the field of correlated electron systems.

One subject of primary interest in fundamental physics is quantum correlation effects in condensed matter. Intensive research on advanced materials has led to the discovery of new compounds with spectacular properties driven by these correlation effects. High magnetic fields allow us to finely tune the delicate balance between different correlation effects. The ability to measure these materials under such conditions is therefore of fundamental importance. The probes available today, however, are mainly limited to macroscopic properties and do not yield direct information on the structural properties, or possible structural changes as function of the applied magnetic field. Any realistic theoretical model must be based on the knowledge of the atomic arrangement because the different interactions strongly depend on it. The determination of the correct crystal structure is thus a prerequisite for the validation of any model of the ordered state and of the underlying interactions. The importance of such structural studies is further emphasised by the observation of anomalies in ultrasound velocity and dilatometry at magnetic field induced phase transitions.

Within this project we intend to combine state-of-the-art methods for the generation of high magnetic

fields with X-ray probes that will allow us to explore the phase diagrams of correlated electron systems in high magnetic fields. Within the field of correlated electron physics, we consider the following to be of particular interest:

Colossal magnetoresistance (CMR) manganites

The perovskite manganites $R_{1-x}A_x\text{MnO}_3$ (R : a trivalent rare earth, A : a divalent alkaline atom) can readily be tuned between radically different states, including ferromagnetic metals, charge-ordered insulators and paramagnetic polaron liquids and show interesting phenomena, like CMR. The solid solution of two cations with different valence states leads to a mixed valence state for the manganese, namely Mn^{3+} ($3d^4 S=2$) and Mn^{4+} ($3d^3 S=3/2$). The degeneracy of the t_{2g} and e_g crystal field levels is partially lifted. For the Mn^{3+} ion, the 3 t_{2g} electrons are considered as localised with local spin $S=3/2$. The e_g electron, on the other hand, can either become itinerant, or it may localise, giving rise to a metal-insulator transition and a charge order state. The exact crystal structure has a large influence on this subtle balance and is not yet clearly understood.

Magnetisation plateaus in low dimensional $S=1/2$ systems

The magnetisation processes of low dimensional quantum spin systems with spatial structures such as spin ladders, exchange-alternating chains and dimers, are new problems in magnetism and do not yet have a theoretical grounding. In most of these systems, it has been predicted that the magnetisation is not a uniform function of the applied magnetic field but rather tends to form *plateaus* where the magnetisation is quantised to a fractional number of the total magnetisation. These plateaus have been observed in the dimer chain compound NH_4CuCl_3 and in the 2D highly frustrated spin-dimer $\text{SrCu}_2(\text{BO}_3)_2$. There is recent evidence for a discontinuous phase transition in $\text{SrCu}_2(\text{BO}_3)_2$ from a uniform magnetisation to a modulated superstructure near 27 T , with a magnetisation plateau at $1/8$ of the full saturation. The possibility of a lattice distortion at the plateaus is strongly supported by ultrasound experiments, in which sharp softening of the elastic constants is observed in high fields.

One of the questions that will be addressed in this project is the nature and magnitude of the atomic displacements occurring at the magnetisation plateaus in 2D quantum spin systems such as $\text{SrCu}_2(\text{BO}_3)_2$ and NH_4CuCl_3 .

Hidden order parameter and metamagnetism in URu_2Si_2

One of the intriguing questions that this project will certainly help to address is the *breaking up* of the heavy fermion ground state under high magnetic fields. Indeed the application of a magnetic field causes the narrowing of the quasiparticle band at the

Fermi energy and thus induces a change in the electronic state of $5f$ electrons, from itinerant to localised. The metamagnetic transitions in URu_2Si_2 constitute a very good example of studies that are to be carried out in this project. These transitions occur in the magnetic field range comprised between 32 T and 40 T, and are accompanied by some defined steps in the magnetisation at $1/3$, $3/5$ and finally at 1. This phenomenon bears some resemblance with analogous plateaus present in intermetallic compounds (non heavy fermion) and in 2D quantum spin dimers and plaquettes, as we have shown in the previous paragraph. It has been theoretically shown that the occurrence of non-integer magnetisation plateaus straightforwardly implies the presence of a superstructure as the number of spins per unit cell has to be integer. This superstructure has been revealed through NMR experiments in the 2D quantum anti-ferromagnet $SrCu_2(BO_3)_2$. Although the comparison between URu_2Si_2 and $SrCu_2(BO_3)_2$ is merely phenomenological, it is nevertheless worth pointing out that the metamagnetic transitions in quantum compounds occur together with lattice distortions.

Techniques

The experimental station will be dedicated to X-ray diffraction and spectroscopy under pulsed magnetic fields in the range of 30 to 50 T. The technical feasibility of such experiments has recently been demonstrated by our pilot experiments at the ESRF (Frings *et al.*, 2006; Mathon *et al.*, 2006) and the work at SPRING-8 in Japan (Matsuda *et al.*, 2004; Narumi *et al.*, 2006).

The proposed experimental station will combine the following X-ray techniques with magnetic field pulses generated by a capacitive discharge: X-ray powder diffraction, X-ray single crystal diffraction (including X-ray resonant scattering) and X-ray absorption spectroscopy (including XANES, EXAFS and XMCD). An integrated cryostat system will provide optimum cooling for the high field coil by immersing it in a liquid nitrogen bath. Furthermore, it will allow the user to vary the sample temperature between 4 and 300 K. Prototype systems have been developed at the LNCMP (Toulouse, France) and at the ESRF (van der Linden *et al.*, 2006) and have been tested successfully on beamlines BM26B, ID20 and ID24.

Although it is the dominant method for the determination of crystal structures, X-ray scattering has so far only been combined with moderate static magnetic fields. At present no synchrotron radiation facility can offer magnetic fields higher than 17 T to its users. Initiatives are under way both in Japan (Matsuda *et al.*, 2004; Narumi *et al.*, 2006) and in the USA to combine X-ray scattering techniques with magnetic fields of 30 T and above.

X-ray powder diffraction is *the* method for small molecule crystal structure determination. Within a relatively simple setup that does not require movements of the sample during data acquisition (except for improving the powder average) it is possible to determine the space group, lattice parameters and angles, and to estimate atomic positions within the unit cell. The initial experimental results (Narumi *et al.*, 2006; Frings *et al.*, 2006) have demonstrated that powder spectra can easily be recorded under pulsed field conditions.

Two disadvantages intrinsic to powder diffraction prompt us to also develop single crystal diffraction: (a) the comparatively low signal/noise ratio does not allow for the detection of magnetic scattering and (b) in powders the magnetic field is applied along a random direction, a significant inconvenience for samples that exhibit strong magneto-crystalline anisotropy and phase diagrams that depend on the direction of the applied magnetic field. We expect that in favourable cases we will be able to directly study superlattice reflections due to magnetic or orbital order using X-ray resonant scattering.

As an alternative to diffraction studies we will offer several X-ray absorption spectroscopy techniques which directly probe the influence of the external magnetic field on the local electronic structure (X-ray absorption near edge structure, XANES) and on interatomic displacements (extended X-ray absorption fine structure, EXAFS). By using an X-ray phase plate to generate a circularly polarised beam we will furthermore study the spin polarised absorption spectra (X-ray magnetic circular dichroism, XMCD). XMCD holds particular promise for high field applications as magnetic field induced phases are stabilised through the Zeeman contribution to their free energy, *i.e.* they necessarily have a finite magnetisation. XMCD offers direct, local, and species sensitive access to the atomic origin of this magnetisation.

Context with new sources and user community

Because of short duration of the magnetic field pulse and the limited number of repetitions (due to the low duty cycle and the finite, fatigue limited life time of the high field coil) all X-ray techniques listed above are flux limited. It is therefore no coincidence that the existing prototype experiments were carried out at the ESRF and SPRING-8.

In particular, powder diffraction requires high photon energies, in the range of 25 to 40 keV due to the limited access angle due to the presence of the pulsed field source. The ESRF is clearly the best existing

source (in Europe) for this application. Amongst the sources under construction, only PETRA-III presents a viable alternative for X-ray powder diffraction and high energy diffraction. The resonant techniques, X-ray absorption spectroscopy and X-ray resonant scattering might eventually be implemented at other European synchrotron radiation sources. Indeed, PETRA-III and SOLEIL have expressed interest in pulsed magnet field experiments (SOLEIL: dispersive EXAFS, PETRA-III: unspecified X-ray technique, presumably powder diffraction).

The potential user community has expressed their interest in such an experimental facility in letters of interest and during the Workshop on *Synchrotron Applications of High Magnetic Fields* held in Grenoble, 16 to 17 November 2006.

Finally, pulsed magnetic fields hold great appeal for X-ray free electron laser sources. However, the experimental protocols need to be determined.

Technical considerations

Single crystal diffraction: Intensity measurements would best be performed in Laue mode, *i.e.* with a wide bandpass monochromator (such as a multilayer system).

Powder diffraction, resonant diffraction, and spectroscopy: These techniques require a narrow bandpass monochromator, *e.g.* a Si(111) or Si(311) double crystal monochromator.

Experiments are flux limited, therefore the experimental station should benefit from a full length straight section. The typical time constant of a magnetic field pulse is in the order of 5 ms for the LNCMP system (Frings *et al.*, 2006). For diffraction experiments it would therefore be of great benefit to have area detectors with a frame rate in excess of 1 kHz: Instead of using only a small time slice of the magnetic field pulse, selected by a fast X-ray shutter, one would record the variations of the diffraction signal as the magnetic field pulse evolves, thus measuring a full hysteresis curve. Data acquired in this way would also allow the detection of systematic errors, *e.g.* due to sample vibrations.

Furthermore, high flux and good detection efficiency are crucial as the life time of the high field magnet is fatigue limited (approximately 1000 shots with field strength over 75% of the design value, *e.g.* 22.5 T for a 30 T magnet coil).

At present, we expect a demand for beam time from external users for approximately 30% equivalent of a full beamline, therefore the experimental station could operate in time shared mode with another application,

ideally one that requires lower intensity timing modes so that the beam time is naturally shared.

Support facilities

Users and beamline staff would require access to sample preparation and characterisation facilities, in particular:

- Basic characterisation techniques for magnetic samples such as magnetisation, specific heat, transport (resistivity) in superconducting magnetic fields up to 15 T, as provided by *e.g.* PPMS and MPMS by Quantum Designs.
- Sample preparation facilities for milling, weighing, compacting and mounting powder samples.
- Sample preparation facilities for orienting, cutting, polishing and quality testing single crystal samples, including an X-ray Laue camera, diamond wheel and wire saw, lapping wheel, and a small four circle diffractometer on laboratory X-ray source.

Note that the facilities cited above would also be of benefit for other projects, in particular MAGSCAT and DICHRO, SMS and NR-HE.

As magnetic fields above 30 T are not commonly found in university laboratories, our users would also profit from the possibility of performing simple characterisation measurements in pulsed magnetic fields.

References

- Frings P., Vanacken J., Detlefs C., Duc F., Lorenzo J.E., Nardone M., Billette J., Zitouni A., Bras W., and Rikken G.L.J.A. (2006), Synchrotron x-ray powder diffraction studies in pulsed magnetic fields, *Rev. Sci. Instr.*, **77**, 063903.
- Mathon O., van der Linden P., and Detlefs C. (2006), X-ray magnetic circular dichroism measured under pulsed magnetic fields up to 30 T, unpublished. Experimental report(s) forthcoming.
- Matsuda Y.H., Ueda Y., Nojiri H., Takahashi T., Inami T., Ohwada K., Murakami Y., and Arima T. (2004), Application of a portable pulsed magnet to synchrotron radiation experiments, *Physica B*, **346-347**, 519-523.
- Narumi Y., Kindo K., Katsumata K., Kawauchi M., Broennimann Ch., Staub U., Toyokawa H., Tanaka Y., Kikkawa A., Yamamoto T., Hagiwara M., Ishikawa T., and Kitamura H. (2006), X-ray diffractometer combining synchrotron radiation and pulsed magnetic fields up to 40T, *J. Sync. Rad.*, **13**, 271-274.

RIXS-PES: High Resolution Resonant Inelastic X-ray Scattering and Photoelectron Spectroscopy

Summary

In this design report we propose a new soft X-ray beamline that would extend and optimise the existing soft X-ray facilities at the ESRF utilising the unique properties of soft X-ray resonant inelastic scattering and soft X-ray photoelectron spectroscopy.

The beamline would exploit resonant inelastic X-ray scattering and photoemission in the 0.4 to 1.9 keV range. Small spots and very high energy resolution would open up new possibilities in studies of the electronic properties of materials based on 3d transition metals, lanthanides and technological semiconductors. In particular the extension of the energy range beyond 1.9 keV would benefit from the 6 GeV energy of the ESRF.

A dedicated straight section would be required to maximise the flux on the sample in order to increase the energy resolving power at the expense of the transmission of the monochromator. A monochromator optimised for high resolution and high stability in fixed energy measurements will be necessary. New instruments for RIXS capable of > 10000 resolving power below 1 keV and at least 5000 in the upper energy range together with the possibility of varying the scattering angle would have to be designed and built. The challenges for the photoelectron instrument is to have very good angular resolution, as well as the more easily attainable, very high energy resolution and giving better than 10000 combined (monochromator and analyser) resolving power.

Scientific case

Overview

Resonant inelastic X-ray scattering (RIXS) can be used effectively to measure the energy and symmetry of neutral electronic excitations in solids (Ghiringhelli *et al.*, 2004). In the soft X-ray range it is particularly useful for strongly correlated electron systems based on 3d transition metals and on rare earth elements, because the excitation and de-excitation processes upon which RIXS is based directly involve 3d and 4f states respectively. As the RIXS final state is neutral and has no core holes, the spectra are little limited by the intrinsic final state lifetime broadening and the instrumental energy resolution is usually the limiting

factor for the detection of detailed spectral features. The development of high resolution RIXS in the soft X-rays has been limited by intensity issues, due to the intrinsically small cross section and to the small angular acceptance of spectrometers. Until now (November 2006) only very few compounds have been measured at the 2p threshold with a combined resolution better than 0.8 eV, and those measurements were made at the beamline ID08 of the ESRF using the AXES (advanced X-ray emission spectroscopy) apparatus (Ghiringhelli *et al.*, 2004). This instrument has achieved < 0.8 eV at the Cu edge, 0.35 eV at the Mn edge and < 0.3 eV at the Ti edge. Around the world, there are a limited number of soft X-ray RIXS projects. Few will give performances clearly superior to those of ID08 (as it is now) in terms of resolving power and the energies ~2 keV will be better served by high energy machines. Thus the project we propose here is unique and ESRF specific. Note that the opportunities opened by high energy resolution are already interesting researchers not normally using synchrotron radiation spectroscopy, so that the user community will grow. For example, the high resolution work looking at the d-d energy losses in cuprates (Ghiringhelli *et al.*, 2004) has stimulated groups to combine results from X-rays and optical techniques to understand the basic electronic structure of these important superconducting materials. The possible application of RIXS to rare earth systems and to technologically interesting semiconductors (Si, Ge, GaAs, GaAlAs) encourages the extension of the energy range up to at least 1.9 keV so to reach Yb M_{4,5}, Al and Si K, Ga, Ge and As L_{2,3} edges with high flux and good energy resolution. In the study of heterostructures, having both fundamental and technological interest, RIXS in this energy range is particularly promising because it makes it possible to probe buried objects on a depth scale interesting for modern nanotechnologies. This is not true if shallow core level edges are used as it would be done at lower energy storage rings. With very high energy resolution and k-resolved measurements low energy losses in titanate and vanadate compounds could be studied (although one covers only a fraction of the Brillouin zone). These are at the limit or beyond our possibilities today. The type of problems that can be addressed are low energy d-d losses and the presence of collective losses like "orbitons".

Angle resolved photoemission (ARPES) has been an important tool in understanding the electronic structure of materials. Traditionally the work has been done in the VUV region where the cross sections are large and high energy- and k-resolution are more easily achieved. In the last few years it has become clear that for certain studies the surface sensitivity of the VUV region is a problem. Typical examples are correlated materials, like rare earth compounds (Venturini *et al.*, 2006), the cuprates (Claesson *et al.*,

2004) and transition metal oxides. Studies, for example at SPRING-8 in Japan and the ESRF (Venturini *et al.*, 2006), and elsewhere, have shown that band structure information can still be obtained in the photon energy range 400 to 1500 eV with better bulk sensitivity but without reaching the XPS limit where only density of states information is achieved. In addition important information can be gained by utilising the absorption resonances in this energy region - $3d$ transition metals 400 to 1000 eV and rare-earths 900 to 1600 eV (Venturini *et al.*, 2006; Sekiyama *et al.*, 2000). For instance, the use of the Ce M absorption edges gives a way of studying the $4f$ states in Kondo materials which have fascinating properties of fundamental interest. Having sufficient signal, k -resolution and/or high energy resolution in these energy regions, particularly up to 1600 eV, is a challenge for the future.

Techniques

Soft X-ray resonant inelastic X-ray scattering and angle resolved photoemission are extremely demanding techniques because they require at the same time all the qualities of a modern X-ray beamline. The two techniques can thus optimally share the same requests from an advanced beamline:

- **Brilliance.** The illuminated spot on the sample must be very small. The flux must be as high as possible because the cross section of the process is small. State of the art focusing will be required to get a vertical spot size of the order of 5 μm .
- **Resolving power.** To perform a RIXS experiment with greater than 10000 combined resolving power, the beam line monochromator must work at least at 20000 resolving power over the whole energy range. This is also exactly the type of resolving power needed for ARPES where the beamline is restricting the performance and not the analyser. Having energy resolutions of tens of millivolts would be a great step forward. This is a challenge in the soft X-ray range.
- **Stability.** RIXS and ARPES experiments are intrinsically slow and long acquisitions are needed. The stability needs to be maintained when varying energy and polarisation. Future gains in the stability of the machine will be directly reflected in the data quality.
- **Polarisation tunability.** The undulator source must be capable of delivering linearly and circularly polarised radiation with any orientation over the whole spectral range. Always being able to work on the first harmonic is a great advantage at the ESRF.

In addition we can further develop other aspects of the methods:

- **Extended energy range.** The 400 to 1000 eV range covers all of the $L_{2,3}$ absorption edges of $3d$ transition metals, light rare earth $M_{4,5}$ edges and oxygen and nitrogen K edges. High resolution RIXS and ARPES above 1 keV up to 1.9 keV would allow

not only all of the rare earth $M_{4,5}$ edges to be covered, but also the K edge of Si (1840 eV) and of Al (1560 eV) and the $L_{2,3}$ edges of Ga, Ge and As (1140 to 1530 eV). Such facilities would fully exploit the advantages of the ESRF in this energy range.

- **Polarimetric RIXS measurements.** Having the possibility of analysing the polarisation of the emitted photon would provide important additional information. Such measurements are extremely difficult in the soft X-ray energy range and a challenge for the future. At higher energies crystal spectrometers could be employed that give easier access to polarisation analysis. Polarimetric measurements in experiments having moderate energy resolution are much easier and are particularly appealing in strongly correlated systems, as recently demonstrated using a polarimeter based on multilayers (Braicovich *et al.*, 2007).

Angle dependent RIXS. The photon momentum is not negligible in the soft X-ray range (compared to the VUV) and it can be used to complement ARPES in the exploration of dispersion in excitations of the system. In RIXS above 1 keV the maximum momentum transferred from the scattering photon to the solid is more than 1 \AA^{-1} meaning that the whole Brillouin zone of most lattices can be explored. Such measurements are difficult, requiring the spectrometer to move about the sample but could provide essential new information. Little has been done to measure the dispersion in k -space of RIXS spectral features although it will be a feature of the new beamline at the SLS. It is also useful to have at least the choice among some angular positions even if the dispersion is not studied. In such a case it will be possible to explore other phenomena *e.g.* in magnetic systems the effects of the symmetry breaking with respect to the traditional RIXS scattering at 90° .

The sum of all those requirements is *per se* a great challenge for any modern synchrotron radiation source. Moreover above ~ 800 eV the ESRF, working at 6 GeV, has an intrinsic advantage over most other European synchrotrons (present and future).

In summary, building an instrument of the future, with in particular very high energy resolution will allow a deeper insight into the electronic structure of many classes materials, both of basic interest, like correlated electron materials, and of more applied interest like semiconductors, magnetoresistive materials etc.

Context with new sources and user community

During the more than ten years of soft X-ray activities at the ESRF the growth of the scientific applications using third-generation light sources has been impressive. Many of these sources have exploited the

possibilities of polarised X-rays and in particular circular polarisation, which is difficult to realise by other means in this energy range. There are currently (2006) more than ten third-generation soft X-ray beamlines in Europe. These cover an extremely diverse range of scientific problems and utilise many different techniques. In the next five years another ten beamlines are planned. These are at the demand of the ever growing scientific communities around Europe. Soft X-rays at the ESRF is already very competitive with existing sources, will remain so in the future and will play an integral part in meeting this increased demand for soft X-rays. Certainly, the ESRF will have to adjust to the changing European scene in order to provide all the European user community state-of-the-art research possibilities. This can be done by building on past successful research programmes, on the synergy with hard X-ray beamlines at the ESRF and by concentrating on activities best optimised at the ESRF and demanded by the user community.

Technical considerations

Technical considerations – source: Based on our experience with many types of helical undulators at the ESRF the choice of source for this beamline would certainly start from the APPLE II type undulator. With an 88 mm period and utilising a full 7 m straight section and 300 mA ring current gives approximately three times the flux of today. The energy range would be ~ 0.4 keV to more than 2 keV using the first harmonic. This solution will give $\sim 100\%$ polarisation (vertical and horizontal linear and circular) over the whole energy range.

Technical considerations – beamline: In order to realise the scientific objectives of this project one needs a soft X-ray beamline that will provide very high photon flux into a few microns spot with very high energy resolution. There are several beamline strategies that can be employed including spherical grating monochromators, variable line spacing (VLS) plane grating monochromators or collimated plane grating monochromators. In principle all of these can reach > 20000 resolving power at 1 keV. Beyond is a challenge, but the real challenge is to have sufficient flux into the spot to allow the measurements to be made. This requires an optimisation of all optical elements (gratings can have efficiencies from 1 to 10% only for instance). State-of-the-art optics are required. Also extreme positional and energy stability over very long periods is required, since data acquisition times can be many hours.

Technical considerations – RIXS spectrometer: Spectrometers for the soft X-ray range have to be based on grazing incidence gratings for all energies below 1 keV and they can provide excellent resolving

power ($E/\Delta E$ from 8000 to 10000) even up to 1.5 keV (Ghiringhelli *et al.*, 2006). Their performance has been evolving in recent years thanks to the improvement of optical elements and of 2D position sensitive detectors based on CCDs. Moreover the increased performance of the synchrotron radiation sources and beamlines have allowed part of the efficiency to be sacrificed in order to gain resolving power. State-of-the-art optical elements as well as the best (smallest pixel size and $> 25 \times 25$ mm² area) directly illuminated CCD detectors are needed.

The AXES spectrometer working at the ESRF since 1994 has demonstrated good performance and has been upgraded continuously. It has also served as starting point for the design and construction of the SAXES instrument of the SLS, capable of 12000 resolving power below 1 keV (Ghiringhelli *et al.*, 2006). Based on this experience we foresee that a three to four metre long spectrometer of similar optical lay out will be perfectly suitable for the next stage of RIXS at the ESRF. It will also reach 10000 resolving power below 1.2 keV and 7000 to 8000 at 1.5 keV. Air cushions or other technologies can be used to allow the rotation of the spectrometer around a vertical axis centred on the sample. Having a continuously variable scattering angle without breaking vacuum is a challenge.

For the higher energy range (1.4 to 1.9 keV) a crystal spectrometer can be envisaged. In fact the Bragg systems have an intrinsic higher luminosity thanks to the high efficiency of Bragg reflections and to the big angular acceptance. The main drawback is the serial acquisition, requiring a $\theta/2\theta$ scan for each RIXS spectrum. ADP(011) or quartz crystals can provide resolving power of the order of 7000 to 8000 at 1.5 keV, *i.e.* similar to grating spectrometers, but examples of much higher resolving power (up to 10000 around 1.7 to 2 keV) exist too. Above 1.5 keV, Bragg systems could perform better than grating spectrometers in terms of energy resolution. A more precise comparison of the efficiencies of the two systems will have to be done for the whole 1.4 to 1.9 keV range. A crystal spectrometer would provide an intrinsic sensitivity to the emitted photons polarisation, useful in exploring the potentialities of RIXS with complete control of the polarisation. The Bragg spectrometers can be more compact but they need to be rotated around the emitted beam to exploit the polarisation sensitivity. Also for this type of spectrometer we envisage the possibility of changing the scattering angle between the incident and scattered beam from the sample. The challenges are to realise efficient crystal optics allowing polarisation dependent measurements. The development of multilayer optics allowing experiments with moderate resolving power but with excellent sensitivity to the polarisation of the beam scattered from the sample should also be considered. For these optics there is a

lot to be gained in optimising efficiency and the band pass, particularly for polarisation dependent measurements where the efficiency drops rapidly as optimal polarisation performance is achieved in the soft X-ray energy range.

Technical considerations – photoemission

spectrometer: Photoelectron spectrometers that can reach the required energy resolution are available today (meV energy resolution is routine) and also for high kinetic energies. However, frequently the count rates are so low that the ultimate resolution can not in practice be realised. Optimisation of electron detection schemes for soft X-ray angle resolved photoemission potentially can improve the data efficiency and should be investigated. Coupling this with efficient high flux optics will make experiments not feasible today, a possibility. The analysers also need to be angle resolving and although spectrometers working up to 1.5 keV are possible, the angular resolution required in the future will be at the limit of what is done today. Ideally spectrometers capable of <0.1 degrees angular resolution are desirable with a parallel detection window of ± 7 degrees or more. Today 0.3 to 0.5 degrees is available over such a window and manufacturers are looking at < 0.1 degrees. Improved k-resolution for the studies of the future is important.

Sample manipulation in UHV with six degrees of freedom and low temperature at the sample (preferably <10 K) is required. Sample transfer from air to UHV is also needed.

References

- Braicovich L., van der Laan G., Annese E., Brookes N.B., Ghiringhelli G., and Tagliaferri A. (2007), Resonant inelastic X-ray scattering from magnetic systems with angular resolution and polarisation analysis of the scattered beam: results on metallic Co, Fe metal and Co ferrite at the $L_{2,3}$ edges, *Phys. Rev. B*, to be published.
- Claesson T., Mansson M., Dallera C., Venturini F., De Nadai C., Brookes N.B., and Tjernberg O. (2004), Angle Resolved Photoemission from $Nd_{1.85}Ce_{0.15}CuO_4$ using High Energy Photons: A Fermi Surface Investigation, *Phys. Rev. Lett.*, **93**, 136402.
- Ghiringhelli G., Brookes N.B., Annese E., Berger H., Dallera C., Grioni, M., Perfetti L., Tagliaferri A., and Braicovich L. (2004), Low energy electronic excitations in the layered cuprates studied by copper L_3 resonant inelastic X-ray scattering, *Phys. Rev. Lett.*, **92**, 117406.
- Ghiringhelli G., Piazzalunga A., Dallera C., Trezzi G., Braicovich L., Schmitt T., Strocov V.N., Betemps R., Patthey L., Wang X., and Grioni M. (2006), SAXES, a high resolution spectrometer for resonant X-ray emission in the 400-1600 eV energy range, *Rev. Sci. Instrum.*, **77**, 113108.
- Sekiyama A., Iwasaki T., Matsuda K., Saitoh Y., Onuki Y., and Suga S. (2000), Probing bulk states of correlated electron systems by high-resolution resonance photoemission, *Nature*, **403**, 396-398.

- Venturini F., Cezar J.C., De Nadai C., Canfield P.C., and Brookes N.B. (2006), The Ce 4f electronic structure in $CeCo_2Ge_2$: a soft X-ray resonant photoemission investigation, *J. Phys.: Condens. Matter*, **18**, 9221-9229.

SMS: Resonant Soft X-ray Magnetic Scattering

Summary

With this project we propose to extend to the soft X-ray scattering regime the experimental and theoretical advances of the resonant X-ray magnetic scattering technique developed in the hard X-ray range at the ESRF. This will provide new research opportunities for the benefit of a wide user community. The key objectives of the project are to:

- Provide a new instrument with a stable, high intensity and focused photon beam for resonant soft X-ray scattering (RSXS) and photon polarisation analysis in the energy range from 500 to 2000 eV.
- Build a dedicated UHV experimental station for very low temperatures (down to approximately 2 K), with azimuthal capabilities and linear polarisation analysis.
- Possible implementation of a second experimental station for high magnetic field studies in the RSXS regime.

This beamline will complement the magnetic scattering beamline operating in the hard X-ray regime (CDR MAGSCAT) as it gives access to important absorption edges, such as the $L_{2,3}$ edges of the 3d transition metals and the $M_{4,5}$ edges of the rare earths. The soft X-ray beamline will have a dedicated multi-circle UHV diffractometer with liquid helium sample cooling system, a polarisation analysis stage and instrumentation for sample orientation and manipulation.

The addition of an ESRF soft X-ray magnetic scattering beamline would permit the cross fertilisation of the experience with magnetic diffraction gained in the hard X-ray region on ID20 on one hand, and the experience with magnetic spectroscopy in the soft X-ray range gathered on ID08 on the other hand. The possibility of covering the whole energy range from 0.5 keV to 30 keV for resonant X-ray scattering (RXS) studies would provide a unique world class facility.

Over the past years pioneering experiments at the L-edges of the 3d transition metals (Wilkins *et al.*, 2003; Wilkins *et al.*, 2003) have demonstrated that resonant X-ray scattering in the soft X-ray regime can

yield unique, interesting information, despite the physical limitation of the available Q range. Polarisation analysis and the azimuthal dependence, techniques first developed for the hard X-ray range, were successfully applied to a wide range of materials, showing that the physics of multiple ordered states can also be probed in the soft X-ray regime (Staub *et al.*, 2005; Mulders *et al.*, 2006; Scagnoli *et al.*, 2006).

Very recently, resonant powder diffraction was demonstrated to be possible in the soft X-ray regime. This unexpected capability can certainly contribute to new areas of research such as, for example, unexplored fields in the domain of molecular magnetism (Staub U., private communication). In other words, the scientific case for a soft branch is not limited to the physics of strongly correlated electron systems, but can cover other areas of magnetism and open new avenues for applied research in nanostructured materials of technological interest. Indeed, the Q range and resolution accessible in the soft X-ray are perfectly matched to the length scales of interest in the emerging research fields of nanomagnetism and orbitronic materials (that use the orbital degrees of freedom within devices) and this area of research still remains largely unexplored.

Scientific case

Overview

Historically the domain of soft X-ray magnetism research was addressed by photo-absorption or photoelectron spectroscopy techniques. These have often been applied to simple mono-atomic or nanostructured materials (exchange bias, monoatomic layered magnetic systems) and studied mostly with circular polarisation across the absorption edges of transition metals (L edges) and rare earth elements (M-edges). The domain of RSXS, as applied to strongly correlated electron systems, is relatively new but has nevertheless already attracted significant attention. The resonant magnetic enhancement at the L-edges of 3d transition metals and the M-edges of rare earth elements are very large, allowing excellent signal-to-noise ratios so that diffraction measurements are relatively easy, despite the limitation of RSXS due to the long wavelength available in the soft energy range. These absorption edges are very important since resonant dipolar transitions in this energy regime access electronic states carrying large magnetic moments: $2p \rightarrow 3d$ transitions in 3d transition metals and $3d \rightarrow 4f$ transitions in rare earths.

A large class of strongly correlated electron systems can be studied, ranging from high- T_c superconductors, multi-ferroics, giant magneto-resistive materials, frustrated low-dimensional magnetic systems. In principle most of the scientific

cases explored by RXS in the hard X-ray regime can be relevant in the soft X-ray regime, when the propagation vectors of the ordered structure are small compared to the photon wavelength (see the conceptual design report for project MAGSCAT). Due to this intrinsic limitation of the available Ewald sphere, the hard and soft RXS techniques must be combined in order to extract complementary information on charge, magnetic and multipole ordered phenomena associated with electronic degrees of freedom. These are the key ingredients for understanding the physics of strongly correlated electron systems.

Besides this main scientific activity, a larger area of research can be addressed in the domain of nanomagnetism and, in particular, nanomaterials of technological interest, for example for confined magnetism, cluster magnetism and complex-oxides/phase separated magnetic systems. The basic ingredients of nanoscience are the geometric confinement, the physical proximity and the self-organisation. This research field is rapidly expanding and requires the cooperation between chemists for the challenge of designing and synthesising new magnetic molecules with tailor made properties and of the physicist, who can experimentally measure the properties and work out the theoretical models required for their interpretation (Gatteschi *et al.*, 2006).

Finally, surface magnetism, buried interfaces and their relationship to interfacial roughness can be probed using diffuse X-ray resonant scattering, a method in which the average diffusely scattered X-ray intensity is compared with the component that reflects the magnetic scattering. Using the element and shell sensitivity of RXS and the large magnetic enhancement at the L-edges of transition metals, the interface morphology and the magnetisation depth can be measured, opening a wide range of experiments on thin films and multilayers.

Techniques

Resonant X-ray diffraction and linear polarimetry

The RSXS technique requires a UHV diffractometer with a horizontal and vertical detector arm and a four circle geometry with azimuthal scan capabilities. The detector arm must support a soft polarisation analyser (typically a multilayer adapted to the resonant energies used in the experiment) which can rotate about the scattering vector to determine the outgoing photon polarisation. A continuous helium-flow cryostat can be designed to reach the basic temperature of ~ 2 K at the sample position. Due to the restrictions imposed by the photon wavelengths and the reduced reciprocal space, an X-ray tube generator can be combined with the UHV chamber in order to pre-align the

sample and determine the orientation matrix before the RSXS experiment.

Resonant soft X-ray scattering under high magnetic fields

A second station can be envisaged with a dedicated high magnetic field split-coil magnet for RSXS experiments. The UHV magnet will apply a vertical magnetic field and the split access will allow a large scattering angle in the horizontal plane. The detector arm will be equipped with a polarisation analysis stage and the variable incident linear polarisation can be used to determine the polarisation and the energy dependence of the resonant signals. The basic temperature reached by the magnet will be about 2 K. Combined experiments using *in situ* techniques such as magnetic (H) and electric (E) fields at low temperature (T) can be easily adapted to investigate the H-E-T phase diagram of multiferroics, to determine the effect of magnetic field in frustrated magnetic systems or to disentangle the multipole order parameters which occur simultaneously in electronic and magnetic phase transitions.

Context with new sources and user community

The scientific possibilities offered by RSXS have stimulated a very high interest in the synchrotron radiation community and in recent years soft X-ray stations adapted for this kind of studies have been put into operation at different synchrotron radiation sources. These stations are built on multipurpose beamlines, and up to now, despite the high user demand, there are no dedicated beamlines for RSXS, nor are they in general specialised for linear polarisation analysis. The existing RSXS station on ID08 ESRF beamline has received a large user demand over the last few years, despite it representing only one activity of the beamline. We would also like to point out that the RSXS is one of the main scientific cases for the new European Free Electron Laser (Hamburg) and that different specialised beamlines are in conceptual design at APS, Brookhaven and Japan. Dedicated stations will be built at ALBA, SOLEIL and DIAMOND. However, the ESRF is and will remain extremely competitive in the soft X-ray energy range and the possibility to complement the RXS in the hard X-ray regime and to cover the whole energy range between 0.5 and 30 keV would provide a world class facility. This would also conserve both the specialisation of the ESRF beamlines (compared to multipurpose beamlines) and the multi-technique character of the ESRF facility.

Technical considerations

Technical considerations – source

At the ESRF there is a lot of experience with many types of helical undulators. Of these the APPLE II type undulator has many advantages in the soft X-ray range, particularly if one wants to be able to rotate the linear polarisation and also have access to circular polarised X-rays. The full energy range (0.5 keV to 2 keV) can be accessed using the first harmonic giving ~100% polarisation for both linear and circular polarised X-rays. However, there are several challenges with this project. The need to rotate continuously the linear polarisation ± 90 degrees will require a modified version of existing undulator designs. Also high flux is needed so the use of a full 7 m straight section will be a great advantage. Such sources also require special considerations for heat load problems in the front end, as power is generated in both planes.

Technical considerations – beamline

To reach the scientific aims of this project one needs a soft X-ray beamline that will provide a very high photon flux. Given that the energy resolution requirements and the spot size at the sample are modest, there are several beamline strategies that can be employed including spherical gratings monochromators, variable line spacing (VLS) plane grating monochromators or collimated plane grating monochromators. The challenge is the energy range around 2 keV where grating monochromators have efficiency problems. Improvements in reflectivity using multilayer gratings should be explored.

Technical considerations – UHV diffractometer

Combining UHV capabilities with a high performance diffractometer (at least a four circle diffractometer, with azimuthal capabilities) giving polarisation analysis of the out going beam and low temperatures (~ 2 K) at the sample is a challenge. Although several projects worldwide (ESRF, SLS, NSLS, ALS, BESSY-II etc.) have made progress in this direction an instrument giving all the degrees of freedom does not exist. In particular, very low temperatures at the sample and full polarisation analysis are big challenges. Cryogenic shielding of the sample is very difficult in the soft X-ray range as there are normally no windows, UHV vacuum is required and large scattering angles are needed. Polarisation analysis requires multilayer optics which typically have very low efficiency in this energy range. In addition many different multilayers will be needed to cover a wide energy range.

Real UHV vacuum conditions (10^{-10} mbar) will allow unique samples to be prepared using, for example,

surface science techniques. However, if the instrument needs to be baked for UHV operation this complicates the design considerably. UHV vacuum is also needed for low temperature operation to prevent ice formation which affects the reflectivity in this energy range. Modest magnetic fields might also be needed in such an instrument. The use of two dimensional CCD detectors should also be explored.

Technical considerations – high magnetic fields

Based on the experience at the ESRF of split-coil high field magnets one can imagine a system optimised for the soft X-ray range. The challenges are, as always, to have sufficient angular range for the scattering, high magnetic fields (as high as possible 7 to 15 T depending on the solutions that can be found) and low temperatures (as low as possible, but reaching ~2 K). Cryogenic shielding is a problem due to the low X-ray energies and the sample also needs to be in vacuum in this energy range, which complicates the cryostat design. Two dimensional detectors, polarisation analysers and the combination of magnetic fields and electric fields will probably all be needed.

References

- Gatteschi D., Sessoli R., and Villain J., (Eds) (2006) "Molecular Nanomagnets" Oxford University Press.
- Mulders A.M., Staub U., Scagnoli V., Lovesey S.W., Balcar E., Nakamura T., Kikkawa A., van der Laan G., and Tonnerre J.M. (2006), High-order Dy multipole motifs observed in DyB₂C₂ with resonant soft x-ray Bragg diffraction, *J. Phys. Cond. Matt.*, **18**, 1-4.
- Scagnoli V., Staub U., Mulders A.M., Janousch M., Meijer G.I., Hammer G., Tonnerre J.M., and Stojic N. (2006), Role of magnetic and orbital ordering at the metal-insulator transition in NdNiO₃, *Phys. Rev. B*, **73**, 100409(R).
- Staub U., Scagnoli V., Mulders A.M., Katsumata K., Honda Z., Grimmer H., Horisberger M., and M. Tonnerre J.-M. (2005), Orbital and magnetic ordering in La_{0.5}Sr_{1.5}MnO₄ studied by soft x-ray resonant scattering, *Phys. Rev. B*, **71**, 214421.
- Wilkins S.B., Hatton P.D., Roper M.D., Prabhakaran D., and Boothroyd A.T. (2003), Soft X-ray Resonant Magnetic Diffraction, *Phys. Rev. Lett.*, **18**, 187201.
- Wilkins S.B., Spencer P.D., Hatton P.D., Collins S.P., Roper M.D., Prabhakaran P., and Boothroyd A. (2003), Direct Observation of Orbital Ordering in La_{0.5}Sr_{1.5}MnO₄ Using Soft X-ray Diffraction, *Phys. Rev. Lett.*, **16**, 167205.

Introduction to the Conceptual Design Reports of the X-ray Imaging Group

Synchrotron radiation based *X-ray Imaging* is one of the priority areas of scientific development highlighted by the ESRF Scientific Advisory Committee and the Council. In addition, *X-ray Imaging* is clearly linked to the other priority topics of *Nanoscience and Nanotechnology* and *Structural and Functional Biology and Soft Condensed Matter*.

The ESRF has a leading position in the development and application of X-ray imaging techniques. This results from the continuous improvement of performance (*i.e.* spatial and temporal resolution) and the completeness (*i.e.* IR end-station complementing X-ray microanalysis beamlines) of the ESRF instrument portfolio. It also derives from the fact that new scientific communities are attracted by the possibilities of these techniques (palaeontology, for example, increased from zero to about 20% of the microtomography proposals over four years). The present Upgrade Programme is currently aiming at offering the best conditions for new science by keeping the X-ray imaging activities at the forefront and pushing for both qualitative and quantitative enhancement of the ESRF potential in this fairly recent competitive discipline. In particular, a major component of this programme is the integration of the various beamlines and related new support laboratories into a unique X-ray Micro-Imaging Platform.

More precisely, the XRI Group Upgrade Programme includes 1) An ambitious and challenging development of the microspectroscopy beamlines (SMILE and XMAN), in terms of spatial resolution, detection limits and X-ray spectroscopy capabilities (EXAFS, FTIR, XEOL), which will provide new scientific opportunities for emerging synchrotron radiation scientific applications such as environment, Earth and planetary sciences, and cultural heritage topics 2) a completely new nanofocus imaging project SFINX on a dedicated straight section, with an emphasis on biological materials, founded on the experience acquired through the pilot projects that are being presently developed 3) an optimised beamline (IMPACT) for all parallel and coherent beam imaging techniques, and in particular fast (fraction of second range) and high resolution (sub micrometre range) microtomography and 4) a beamline for biomedical imaging and radiotherapy clinical trials (CPR) aiming at treating brain tumours that otherwise have no cure. This work could initiate a European Partnership on Cancer Research. This platform, complemented by laboratories (micromanipulation, biomedical facility, open to all the ESRF and the users community), is of actual added value, making it possible to work on a wide variety of scientific topics not accessible today (see CDRs and science chapter of this report). Its achievement is critically dependent of the infrastructure developments foreseen in the Upgrade

Summary of individual CDRs

| | | |
|-----------------------|---|----------|
| CPR | Development of Clinical Protocols in Radiotherapy: A programme to develop clinical protocols on human brain tumours using microbeam radiation therapy and stereotactic synchrotron radiation therapy. | page 111 |
| IMPACT | Imaging using Parallel Beam and Computed Tomography: Complementary to the micro-/nano-focus beamlines, providing a high quality parallel, homogeneous and coherent beam for computed tomography and parallel beam imaging techniques, with spatial resolutions in the micron and sub-micron range. | page 116 |
| SFINX | Scanning Fluorescence and Imaging at the Nanoscale using X-rays: An intense state-of-the-art nanoprobe providing unique very high resolution capabilities for 3D imaging and fluorescence microanalysis. | page 119 |
| SMILE and XMAN | Spectro-Microscopy and Imaging at Low Energies and X-ray Spectroscopy Multi-Imaging Analysis: A multimodal analysis platform based on the use of infrared and X-ray microspectroscopies, microdiffraction and X-ray imaging techniques. | page 121 |

CPR: Development of Clinical Protocols in Radiotherapy

Summary

Programme, which will allow extended or new beamlines, as well as their associated laboratories, to be hosted. To a large extent, this programme will rely upon the development of state-of-the-art X-ray optics. The detector programme is also of paramount importance, in particular for the applications to biological materials, a dose reduction implying higher efficiency while retaining the same spatial resolution.

The upgrade programme of the X-ray Imaging Group is not an isolated one: it has clear links with other, "companion", CDRs, which include **OPTICS**, the evolution of **BM05**; the **EDXAS** project and complementary to **SMILE** and **XMAN**, which opens the way to applications such as "imaging" of valence state/local structure in inhomogeneous systems, **HIENE** for high energy imaging, **MATSCI** for materials science; **MINADIF** for nano-SAXs/WAXs; and **CDI** for a complementary use of coherent beam imaging.

The ID17 research programmes will focus on the development and the exploitation of two radiation therapy (RT) techniques, namely MRT (microbeam radiation therapy) and SSRT (stereotactic synchrotron radiation therapy). Both techniques are currently being proposed for clinical trials (phase I and phase II) in brain tumour bearing patients. These trials will aim (i) to demonstrate the technical and medical application of these novel RT techniques in safe conditions for the patients (phase I) and (ii) to show benefits (in terms of increased life span and/or reduced side effects) with respect to conventional RT techniques.

The realisation of the clinical trials will require the beamline refurbishment for an accurate and precise control of the dose delivery. In particular, adequate patient positioning and safety systems, beamline control software and treatment schedules have to be developed.

In addition to the clinical trials project, the proposed upgrade of the ID17 beamline will permit development of preclinical research addressing open questions in biomedicine and radiation oncology, such as (i) the study of radiation effects on tumoural and healthy tissues at the microscopic level, (ii) increasing knowledge on the mechanisms (at the molecular, cellular and tissue level) involved in the tissue repair (iii) following up tumour growth (iv) the study of radiation therapy efficiency associated with dose-enhancer drugs.

Scientific case

Overview

Biomedical applications of synchrotron radiation have gone through a large increase in impetus and development in recent years, with very significant increases in both the user community and in the number of publications. Part of this drive can be attributed to the radiation therapy programmes aiming at studying and treating brain tumours. This kind of research is motivated by the fact that, despite considerable efforts in cancer therapies, brain tumours and, in particular, gliomas, are extremely resistant to actual clinical treatments. The incidence of gliomas is about 5 to 11/100,000 people and virtually no patients with high-grade glioma survive for more than five years after diagnosis (Behin *et al.*, 2003).

Over the last few years, in collaboration with different groups of users, the ID17 biomedical beamline has developed innovative preclinical research in radiotherapy for targeting brain tumours. Two different techniques, namely the microbeam radiation therapy (MRT) and the stereotactic synchrotron radiation therapy (SSRT) have been used, aiming at treating infants (MRT) or adults (SSRT).

The principle of using microbeams as a potential alternative to radiotherapy lies, on one hand, in the destruction of the vascularisation of the tumour and, on the other hand, in the high normal tissue tolerance of such microbeams (Dilmanian *et al.*, 2001; Laissue *et al.*, 2001). MRT preclinical programmes have been developed in the perspective of the clinical application at the ESRF. MRT is able to cure a significant number of aggressive tumours in rodents (Miura *et al.*, 2006) and the long term survival rate is even improved when MRT is combined with immunotherapy (Smilowitz *et al.*, 2006).

SSRT is based on inserting a high Z element (such as iodine or platinum, associated or not with a chemotherapeutic drug which is targeting DNA), either into the cells or in the tumour, and on irradiating the target with monochromatic X-rays. As for MRT, SSRT preclinical programmes have been clinically oriented, firstly applied to cells (Corde *et al.*, 2003) and then to living animals. In SSRT treated highly aggressive tumour bearing rats, a very significant extension of the life span has been observed in animals previously inoculated with iodinated compounds (Adam *et al.*, 2006) whilst an important fraction of animals has been cured when SSRT has been performed with high Z elements associated with chemotherapeutic drugs (Biston *et al.*, 2004).

Besides the clinically oriented research, the MRT and SSRT techniques permit the study of fundamental radiobiology and radio-oncology scientific cases. In fact, it is possible to investigate the mechanisms related to the interaction of radiation with cells and tissues, including apoptosis (programmed cell death), the bystander effect (indirect communication between cells), DNA reparation channels following radiation damage and the synergy of radiotherapy and chemotherapy. A better understanding of these processes will bring information of critical importance not only for MRT and SSRT, but also in clinics (Risser *et al.*, 2006). Moreover, preclinical experiments are a major tool for testing new drugs aiming at curing cancer, prior to human clinical trials (Adam *et al.*, 2005). Additionally, studies linked to the tumour vasculature are of general interest in cancer research, which should open the doors to a larger scientific community. Several pilot experiments in these fields have already been performed and the potential

development is enormous (Serduc *et al.*, 2006; Foray *et al.*, 2005).

Preclinical MRT and SSRT experiments provided results paving the way to clinical trials at the ESRF. The ESRF is presently, and will, in the near future, be the only synchrotron radiation facility in the world where clinical trials in radiotherapy will be possible. This reality is related to several factors: the presence, on the same site, of a beamline with adequate spectrum and X-ray fluency, the ID17 biomedical infrastructures, and the strong collaborations with hospital teams.

In order to reach this goal and to continue preclinical research in large animals, which are physiologically close to humans, the ID17 beamline needs to be refurbished. With regard to MRT, irradiations are presently performed in a small optics hutch at about 35 m from the source. In order to meet with safety and ethical constraints, and to have a beam width adapted to treat large tumours (≥ 5 cm), we propose to construct a new hutch downstream from the present one, furnished with instrumentation adapted for MRT. An additional wiggler X-ray source, which will also serve for all other imaging and therapy applications, will have to be installed to compensate for the reduction of dose rate due to the increased source to target distance.

With regard to SSRT, a minor refurbishment is also required, which includes a patient positioning system and the development of software for controlling the dose delivery (implementation of the treatment planning).

Techniques

Microbeam Radiation Therapy

MRT uses arrays of X-ray microbeams (typically 25 to 50 microns wide) to deposit extraordinarily high doses (>300 Gy) in the target tissues. The microbeams, of energies around 50 to 150 keV, are created by a multislit collimator for hard X-rays and must be delivered in a fraction of a second to assure minimal broadening of the microslices of intensely irradiated tissues attributable to the movement of the target. For this reason the only suitable source is a synchrotron. The MRT technique is challenging from the point of view of quality control, including the production of identical microbeams, the absolute microdosimetry and patient safety. A new multislit collimator will be installed in the new hutch, closer to the patient, which will assure a reduced penumbra determined by the X-ray source. Beam monitors, under development in collaboration with external institutes, will permit the online control of the individual microbeams. The patient positioning system will allow both child and adult patients to be treated. All of these developments will also guarantee

a more efficient use of MRT for preclinical and radiobiology studies.

Stereotactic Synchrotron Radiation Therapy

SSRT uses monochromatic X-ray beams of 30 to 80 keV for treating tumour targets loaded with high Z elements. The tumour is placed at the centre of rotation of a stage and the radiation is distributed uniformly over 360°. Local dose enhancement results from both the photoelectric effect of the low-energy X-rays on high Z atoms and the ballistic effect induced by the irradiation geometry, which concentrates the beam on the tumour. High dose rates of monochromatic beams are presently available only at synchrotron radiation sources.

With the patient positioning system proposed here, it will be possible not only to treat patients during clinical trials, but also to perform preliminary large animal studies to prepare and test treatment planning. By the development of the treatment planning system, it will be possible to improve dose delivery control in preclinical research programmes, thereby permitting the proposed research to continue.

Context with new sources and user community

Beamline ID17 is one of the three facilities in the world dedicated to biomedical applications (together with BL20XU at SPRING-8 and SYRMA at ELETTRA) and is presently the only one where

preclinical programmes in both imaging and radiation therapy are running. In the coming years, no additional medical beamlines are foreseen at the EU synchrotrons, but two new beamlines, with characteristics and capabilities similar to ID17, will become operational at the Canadian and the Australian Light Sources.

The biomedical synchrotron community has been constantly growing in the past years, in particular thanks to the developments in radiotherapy. The proposed ID17 refurbishment is solicited by several user groups, in particular all the teams using the MRT technique and the INSERM-CHU (Grenoble Hospital) team for SSRT. When completed, the ID17 beamline will be positioned as *the* ideal place in the world for synchrotron radiotherapy research and clinical trials.

Technical considerations

The implementation of the clinical phases requires a number of instrumentation tasks as described hereafter.

MRT

The MRT upgrade consists of installing a dedicated experimental hutch (for white beam) just downstream of the presently existing optical hutch OH1 of ID17 (actually also used to house the MRT experimental station). The existing control and access hutches also have to be rebuilt.

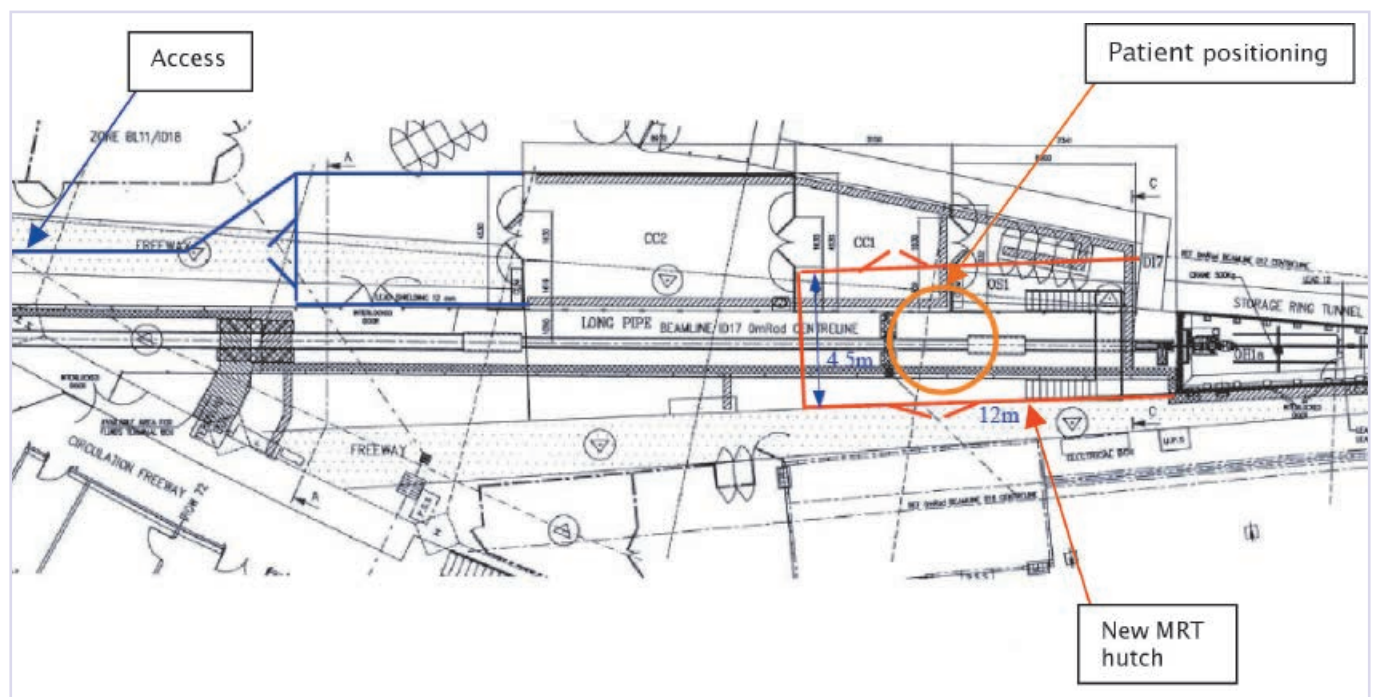

Figure 1: Schematic of the proposed ID17 upgrade showing the section to be housed inside the current experimental hall (the new MRT dedicated experimental hutch).

The new control/access cabins will be constructed along the existing X-ray transfer tube to the current ID17 satellite building (outside the experimental hall). These cabins will be designed to house the instrument controls, a patient reception and preparation area and a dedicated access to the MRT station from outside.

MRT uses extremely high dose rates (~ 20000 Gy/s) and high X-ray energies (mean energy ~ 100 keV). The new experimental hutch for MRT will have a size of $4.5 \times 12 \times 3.4$ m³ (*width x length x height*) with shielding appropriate for such high energies. It will house the optical elements including a multislit collimator to spatially fractionate the white X-ray beam, a chopper, the patient positioning system, a stage for detectors (*e.g.* for a FReLoN-camera for imaging target before the treatment) and the safety shutters to protect the second part of the beamline. The white beam chopper will be a new development; it will serve as beam collimator, but also as a first safety shutter for MRT.

The patient positioning system will be designed to allow for aligning the target tumour to the beam; its movement will be interlocked with the patient safety system, directly acting on the radio frequency synchronisation signals of the machine.

With the new experimental hutch, the present optical elements in the optics hutch OH1 will be re-arranged; the first element will be a newly developed gas based X-ray filter as an additional passive safety system for patients, able to eliminate the useless and potentially dangerous low energies from the white beam. Most of these elements will have to be re-evaluated and adapted (or rebuilt) to cope with the expected increase of heat load (increase of synchrotron stored current to 300 mA).

SSRT

For the SSRT clinical programme the existing experimental hutch EH1 in the ID17 satellite building will have to be upgraded. A suitable patient positioning system will be developed to accurately align the target to the beam and to avoid any movement during the treatment. A system to modulate the incoming beam in size (to follow the tumour size from any irradiation port) and intensity (to compensate for the absorption in the tissues during the patient movement) will be developed.

The patient safety system (PASS) presently installed at EH1 and formally used for the angiography program, will be refurbished to include patient rotation control. The patient facility (reception, waiting room), which already exists in the satellite building will also be refurbished.

Construction of a third experimental hutch and modification of the satellite building

In the present beamline configuration, a lot of time is spent by the team installing, aligning and commissioning the experimental setups before every experiment performed in the second experimental hutch (in the satellite building). In fact, given the structure of the hutch, the setups must be dismantled after almost every experiment, to leave space for the next one. This happens in particular for the *in vivo* and *in vitro* microtomography experiments, the diffraction enhanced imaging (DEI), the cell irradiation and several others.

In addition, the realisation of the clinical trials in the second experimental hutch (SSRT) will determine a reduction of the beamtime available for preclinical research. In fact:

- Beamtime is needed for the commissioning of the beamline before every clinical trials session (patient positioning system, implementation of the treatment planning, dosimetry) and during the treatment itself (mainly performed during the week and working time);
- The setup for the patient treatment installed in the experimental hutch has to stay untouched during the full commissioning and treatment time.

A way to increase the efficiency of the use of the beamtime, and to optimise the work load of the beamline staff, is to build a third experimental hutch just after the second one. This will permit:

- The permanent installation of some setups not related to clinical trials (in particular the DEI setup but not exclusively); they will be pre-aligned with the beam and, being permanently installed, can be continuously optimised;
- The full dedication of the second experimental hutch to the clinical trials, the furnishing of the hutch can therefore be optimised for this purpose;
- The temporary installation and commissioning of additional setups whilst running experimental sessions in the second experimental hutch;
- A much better temperature stability as well as appropriate vibration insulation that can be built in the new hutch, which would have a direct positive impact on the image quality;
- Realisation of experiments/tests with synchrotron radiation during the commissioning of the SSRT clinical trials, and during the dead times of the trials (overnight, during week-ends) when the setups installed in the second experimental hutch cannot be modified.

An appropriate size of the new experimental hutch for monochromatic beam would be 5×4 m². The X-ray beam would be transported from the second experimental hutch within an evacuated (10^{-3} mbar) aluminium pipe. The two hutches will be separated by a beam shutter, which will be closed when the experiment is running in the second experimental hutch.

The construction of this third hutch will imply some additional benefits for the beamline such as the modification and the displacement of the staircase to access the beamline hutch from the building gate.

As a complement to this construction, we propose to upgrade the present connection between the satellite building and the animal facility. The present footbridge at the first floor will be transformed into a close building for offices. As a consequence, the offices on the first floor of the second building can be freed and made available to the bio-medical facility (BMF). The second building will therefore be fully dedicated to the BMF laboratories with a clear gain in term of efficiency and safety (no more laboratories and offices in the same building).

Support facilities

History and present status

The ability of the ID17 biomedical beamline to attract the biomedical community is strongly dependent on the availability of ancillary laboratories used for the preparation and analysis of biological samples after irradiation. For scientific, ethical and safety reasons, these laboratories have to be close to the experimental station and they are used not only during synchrotron radiation experimental sessions, but also for off-line experiments (cell culture before and after irradiation, follow up of animals after treatment etc). Moreover, other beamlines such as ID02, ID19, ID21 and ID22 require punctual access to the same kind of infrastructure and support. The bio-medical facility (BMF) within the X-ray Imaging Group, has been created for this purpose: it consists of several laboratory spaces, defined as user platforms:

- The L2 (biohazard level) cell biology laboratory (20 m²) is available for the culture of animal and human cells (i) prior to irradiation with the X-ray beam (at ID17 and ID21) or with the X-ray generator for *in vitro* radiotherapy experiments, (ii) prior to implantation of these cells in rats (microsurgery) in order to obtain high grade intracerebral tumours (*in vivo* imaging and radiotherapy protocols).
- The animal facility (150 m²) has developed an expertise in the field of *in vivo* brain tumour models induced in rodents (rats, nude mice). Moreover, animal models used for functional imaging have been developed (lung physiology and brain perfusion studies on rabbits, heart models on pigs, osteoarthritis models on guinea pigs etc).
- The histology laboratory (25 m²) is equipped for paraffin embedded staining of tissues. Very soon, cryo-conserved tissues will also be processed. Analysis of histology modifications following various irradiation modalities after imaging or therapy is possible on site, due to the availability of an optical

microscope. This laboratory should be completed with an immuno-fluorescence microscope.

- The L1 molecular biology laboratory (20 m²) is used for immuno-histo-chemistry procedures or DNA and protein extraction after irradiation of cells. These procedures are used to allow understanding of the biological effects of radiation on cells and on biochemical compounds at the subcellular level. The cells can come from *in vitro* (cell cultures) as well as *in vivo* experiments (rodent tissues).
- A sample laboratory (10 m²) is operational very close to the ID17 imaging hutch in order to allow (i) the storage and preparation of formalin/frozen/fresh/dry excised tissues involved in imaging sessions at the beamline (post mortem experiments for the purpose of DEI and paleontology); (ii) the weighing of chemical powders and the preparation of solutions for experiments.

Future developments of the animal facility

In parallel to the development of beamlines, the BMF has to pursue its own development to offer *innovative in vivo* models and *in vitro* techniques to be used in synchrotron radiation biomedical research.

- Immuno-depressed rodents for *in vivo* tumour model studies. Immuno-depressed animals are used for the development of implanted human tumoural cell lines. Consequently, the BMF will have to manage the housing of such delicate animal models. Such animals must be separated from others, for sanitary and safety reasons and to fulfil legal requirements.
- Large animals. Preclinical and clinical studies on large animals are necessary both for the preparation of clinical trials and for fundamental radiobiology studies; a room allowing the housing of such animal models has been foreseen at the BMF. Due to the lack of space, this room is used both for the occasional housing of large animals and for the permanent housing of rodents; this impairs the scientific activity and the sanitary status of the BMF.
- Imaging models: independently and outside of the radiotherapy programme, user groups are using *in vivo* models for quantitative and functional imaging studies (*i.e.* (i) asthma on rabbit lungs (ii) osteoarthritis on guinea pigs (iii) drug kinetics and (iv) microvascularisation development in brain models in rodents).

Expanding the animal facility would allow us to house and make available new pertinent *in vivo* models on site for the beamlines and user communities concerned, taking into account the variety of the projects amongst the X-ray Imaging Group and as a consequence, the housing constraints due to the various species and models. In particular, the large animal area should be dedicated to that purpose, whilst the rooms dedicated to rodents should be enlarged. In parallel, the extension of the building

would be an opportunity to establish a redundancy of the very sophisticated air treatment central unit controlling the BMF ventilation which would allow maintenance of animal dedicated spaces (and also in case of emergency, like contamination, absence of cooling/heating etc.) with no need to evacuate animals (thereby increasing effort and animal stress) to temporary areas.

To conclude, the extension of the animal facility building would allow:

- The L2 and L1 activities to be separated, as has already been done for the cell biology laboratories;
- The co-existence of several animal species, used in imaging and therapy protocols at ID17 and on the other imaging beamlines;
- Large animals to be housed in a professional manner in view of trials prior to humans protocols.

Future developments of the other BMF laboratories (L1 molecular biology, L2 cellular biology, histology).

Two projects are currently under investigations by BMF staff in close collaboration with the user communities. These projects will be presented later as a proposal from the support groups.

References

- Adam J.F., Biston M.C., Joubert A., Charvet A.M., Le Bas J.F., Esteve F., and Elleaume H. (2005), Enhanced delivery of iodine for synchrotron stereotactic radiotherapy by means of intracarotid injection and blood-brain barrier disruption: Quantitative iodine biodistribution studies and associated dosimetry, *Int. J. Radiat. Oncol. Biol. Phys.*, **61**, 1173-1182.
- Adam J.F., Joubert A., Biston M.-C., Charvet A.-M., Peoc'h M., Le Bas J.-F., Balosso J., Esteve F., and Elleaume H. (2006), Prolonged survival of Fischer rats bearing F98 glioma after iodine-enhanced synchrotron stereotactic radiotherapy, *Int. J. Radiat. Oncol. Biol. Phys.*, **64**, 603-611.
- Behin A., Hoang-Xuan K., Carpentier A.F., and Delattre J.Y. (2003), Primary brain tumours in adults, *Lancet*, **361**, 323-331.
- Biston M.C., Joubert A., Adam J.F., Elleaume H., Bohic S., Charvet A.M., Esteve F., Foray N., and Balosso J. (2004), Cure of Fisher rats bearing radio resistant F98 glioma treated with cis-platinum and irradiated with monochromatic synchrotron X-rays, *Cancer Research*, **64**, 2317-2323.
- Corde S., Balosso J., Elleaume H., Renier M., Joubert A., Biston M.C., Adam J.F., Charvet A.M., Brochard T., Le Bas J.F., Esteve F., and Foray N. (2003), Synchrotron photoactivation of cis-platin (PAT-Plat) elicits an extra-number of DNA breaks that stimulate RAD51-mediated repair pathways, *Cancer Research*, **63**, 3221-3227.
- Dilmanian F.A., Morris G.M., Le Duc G., Huang X., Ren B., Bacarian T., Allen J.C., Kalef-Ezra J., Orion I., Rosen E.M., Sandhu T., Sathe P., Wu X.Y. Zhong Z., and Shivaprasad H.L. (2001), Response of avian embryonic brain to spatially segmented X-ray microbeams, *Cellular and Molec. Biol.*, **47**, 485-494.
- Foray N., Charvet A.M., Duchemin D., Favaudon V., and Lavalette D. (2005), The repair-rate of radiation-induced DNA damage: A stochastic interpretation based on Gamma function, *J. Theor. Biol.*, **236**, 448-458.
- Laissue J.A., Blattmann H., Di Michiel M., Slatkin D.N., Lyubimova N., Guzman R., Zimmermann W., Bley T., Kircher P., Stettler R., Fatzer R., Jaggy A., Smilowitz H.M., Brauer E., Bravin A., Le Duc G., Nemoz C., Renier M., Thomlinson W., Stepanek J., and Wagner H. (2001), The weanling piglet cerebellum: a surrogate for tolerance to MRT (microbeam radiation therapy) in pediatric neuro-oncology, *Proc. SPIE*, **4508**, 65-73.
- Miura M., Blattmann H., Brauer-Krisch E., Bravin A., Hanson A.L., Nawrocky M.M., Micca P.L., Slatkin D.N., and Laissue J.A. (2006), Radiosurgical palliation of aggressive murine SCCVII squamous cell carcinomas using synchrotron-generated X-ray microbeams, *Br. J. Radiology*, **79**, 71-75.
- Risser L., Plouraboué F., Steyer A., Cloetens P., Le Duc G., and Fonta C. (2006), From homogeneous to fractal normal and tumorous micro-vascular networks in the brain, *J. Cer. Blood Flow and Met.*, **27**, 293-303.
- Serduc R., Vérant P., Vial J.-C., Farion R., Rocas L., Remy C., Fadlallah T., Brauer E., Bravin A., Laissue J., Blattmann H., and van der Sanden B. (2006), *In vivo* two-photon microscopy study of short-term effects on normal mouse brain microvasculature after microbeam irradiation, *Int. J. Radiat. Oncol. Biol. Phys.*, **64**, 1519-1527.
- Smilowitz H.M., Blattmann H., Bräuer-Krisch E., Bravin A., Di Michiel M., Gebbers J.-O., Hanson A.L., Lyubimova N., Slatkin D.N., Stepanek J., and Laissue J.A. (2006), Synergy of Gene-Mediated Immunoprophylaxis and Unidirectional Microbeam Radiation Therapy for Advanced Intracerebral Rat 9L Gliosarcomas, *J. Neuro-oncology*, **78**, 135-143.

IMPACT: Imaging using Parallel Beam and Computed Tomography

Summary

The IMPACT project, located on the long beamline ID19, complements the micro-/nano-focus beamlines by providing a high quality parallel, homogeneous and coherent beam for computed tomography and parallel beam imaging techniques, with spatial resolutions in the micron and sub-micron range. These techniques, in particular microcomputed tomography, are being increasingly applied to a wide range of topics, which include materials science, biological and biomedical samples, cultural heritage (for instance palaeontology), environmental sciences and industrial applications.

Scientific case

IMPACT within the X-ray imaging upgrade project

The X-ray Imaging (XRI) Group upgrade programme includes the enhancement of the possibilities of the microspectroscopy beamlines ID21 (project **SMILE**) and ID22 (project **XMAN**) and a new "nanofocus" imaging project **SFINX** on a dedicated straight section (IDxy, to be decided), with an emphasis on biological materials, resting on the experience acquired through the pilot projects that are being presently developed. Within the framework of this programme the role we wish to assign to ID19 is complementing the micro-nanofocus beamlines by providing a high quality parallel, homogeneous, and coherent beam for computed tomography and parallel beam imaging techniques with spatial resolutions in the micron and sub-micron range. Whereas it has been recognised that the present achievements of ID19 in what concerns parallel beam imaging are unique in the world, new technical possibilities and improvements in automation, detection, software and sample environment are clearly required to respond to the users demand. This constitutes the **IMPACT** project.

IMPACT: the various scientific cases

There is no single scientific case for the **IMPACT** techniques, which, in fact, cover a large variety of scientific topics from materials science and engineering to life sciences and cultural heritage. This does not mean in any way that the techniques are not science driven: a relevant example here is the success achieved by the beamline team in identifying, pursuing and establishing the link with palaeontological research, and adapting the techniques to the needs of this community (Chen *et al.*, 2003; Chaimanee *et al.*, 2003; Tafforeau *et al.*, 2006). We foresee, with an upgraded beamline, other such success stories in the future, with other scientific communities. An effort is being made towards earth and environmental sciences for the use of *in situ* and real time studies. Last but not least, the number of industrial users can also be increased by retaining the professional manner in which this activity is managed by the dedicated industrial engineer.

Three series of proposed, or recently performed, experiments show the scientific applications of the techniques and indicate the way we wish to see their potential evolving.

1. Materials science and engineering: the use of high resolution (pixels sizes in the sub-micron range, 0.3 and 0.7 μm) phase contrast computed microtomography has allowed direct visualisation and correlation of the interaction between microstructure and damage mechanisms. A recent proposal, which was highlighted by the review panel, intends to study the way a crack propagates in highly heterogeneous materials such as $\alpha + \beta$ titanium alloys and reinforced

β titanium alloys under fatigue loading conditions. This type of experiment requires combining the highest possible spatial resolution whilst retaining a representative volume, together with an adapted sample environment (images recorded during a fatigue test), as well as sophisticated software allowing extraction of the relevant data from the images.

2. Biological systems: the investigation of arabidopsis seeds is a very good example of how holotomography has made 3D images and renditions of an autonomous living object at the sub-micron scale and in a non-destructive manner possible. The visualisation of an unknown network of air space, not visible by other means and believed to have an important role in plant life, is one of the major findings of this investigation (Cloetens *et al.*, 2006). This type of imaging provides, in a unique combination, the desired resolution (0.3 μm pixel size), a relatively large field of view (0.6 mm) and depth investigation capacity (the whole sample). The extension of high resolution X-ray imaging to biological materials is of paramount importance. It implies an effort towards dose reduction through an improvement of the detector capabilities (higher efficiency while retaining the same spatial resolution).

3. Environment: understanding how snow deforms at the grain scale in the creep regime implies performing mechanical tests interpreted in terms of constitutive behaviour through microscale numerical simulations. This topic is of high importance to predict snow mantle behaviour and avalanches. These experiments require both very short exposure times, to preserve the snow surface from sublimating, a representative volume, and the combination of imaging and grain tracking techniques, this combination being developed by the beamline team.

IMPACT: future steps

There is no doubt that there are numerous potential communities that could, in the future, make use of the capabilities of high resolution synchrotron microtomography, for example, the chemical processing industry or the semiconductors devices industry through applications of laminography, etc. There is also a demand for high quality microtomography with a large field of view with high energies, especially in paleontology and for industrial applications. However, a realistic programme of expanding the user base can only be undertaken if sufficient capacity and opportunities exist for exploration. The current over subscription rate of 4:1 discourages promoting the technique to new communities. The ways to provide beamtime to most of the high quality proposals are:

- (a) To increase the detection efficiency and automation of tomographic imaging experiments.
- (b) To substantially decrease the time of setting up new experiments (in particular when new techniques are tested or commissioned, or when a special sample environment has to be mounted). This can be

achieved by having permanently aligned setups for the various needs, and a new experimental hutch where experiments can be prepared whilst the beam is used in the previous hutch, increasing the amount of usable beamtime.

(c) to construct a side branch on ID19 to develop large field imaging (up to 30 cm wide) using high energy monochromatic coherent beam (up to 150 keV). It would bring extremely high quality data on large and absorbing samples. Such an end-station would allow, for example, to image most of the complete fossil hominid skulls with a quality unachievable anywhere else in the world.

(d) To implement more efficient and user friendly data reduction procedures. Regarding data reduction and analysis there is room for serious improvement, most specifically in the area of image reconstruction and optimisation. One of the aims is to bring the reconstruction of 3D images to the timescale of data acquisition because carrying out ground breaking scientific experiments often requires being able to evaluate the results of measurements as they come in, which can only be achieved by near real time data analysis.

(e) The sample environment is an essential ingredient of the IMPACT scientific case: often what is interesting is to perform imaging to follow the evolution of a system as a function of an external parameter. The construction, test and installation of these new devices requires collaboration with the ESRF Sample Environment Group and expert users' groups. These devices will, then, be available for the whole user community.

IMPACT will, in this way, be able to provide a very interesting combination of spatial resolution, field of view and acquisition time, allowing the visualisation of pertinent detail while performing *in situ*, real time processes on samples having a volume large enough to be representative of the actual interesting phenomena.

Context with new sources and user community

In spite of the rapid growth of the use of synchrotron radiation based imaging techniques, and in particular of absorption and phase contrast microtomography applications, the number of foreseen beamlines devoted to parallel beam imaging in Europe remains substantially below demand. Presently the only beamline located on a third-generation machine and devoted to tomography outside the ESRF is at the SLS, the "super-bending-magnet" TOMCAT. One of the reasons is that this type of imaging mostly requires high energy (>15 to 20 keV) photons. No equivalent project for large-field high-energy extension exists.

Technical considerations

All of these parallel beam imaging techniques require a wide (going from mm² to several cm²), coherent and homogeneous beam. They include two microtomographic instruments that incorporate all the advances performed over the last few years at the ESRF in the use of these techniques (Baruchel *et al.*, 2006) and a new end-station with a large field imaging microtomograph directly derived from the existing ones:

- High resolution microtomography (pixel size in the 0.2 to 2 μm range), increasingly used for several topics, which include biological, earth science and materials science samples;
- Medium resolution microtomography (pixel sizes in the 2 to 20 μm range), very important for environmental and cultural heritage topics, as well as various *in situ* experiments involving the use of special sample environment (traction, compression, fatigue machines, cryostats or furnaces, ...);
- Laminography (Helfen *et al.*, 2005), for 3D imaging of flat samples (semiconductor materials, but also flat fossils, paper, felt, ...);
- Diffraction contrast tomography, that simultaneously provides the orientation of the grains and the damage in polycrystalline material;
- Diffraction enhanced imaging, with an analyser crystal after transmission through the sample: this technique shows very promising capabilities for the visualisation of damage in cartilages, a very important biomedical topic;
- Bragg diffraction imaging (X-ray topography and rocking curve imaging) of crucial importance for the characterisation of high perfection crystals for industrial or applied purposes, but also for fundamental science (phase transitions, defect and domain movements).

A revolver insertion device and a series of compound refractive lenses correcting for the angular aperture of the beam and providing an actual parallel beam when needed, allow the beam to be tailored to optimise it for the used parallel beam technique.

Support facilities

The support facilities are already included in the other CDRs presented by the XRI Group. Some of these facilities could be included perfectly into the new building that is proposed to host the new experimental hutch of ID19. This building should be connected to the other facilities (SMILE and XMAN, as well as SFINX) by easy paths, in order to preserve the crucial synergy between all these projects.

References

- Baruchel J., Buffiere J.Y., Cloetens P., Di Michiel M., Ferrie E., Ludwig W., Maire E., and Salvo L. (2006),

Advances in synchrotron radiation microtomography, *Scripta Materiala*, **55**, 41.

- Chaimanee Y., Jolly D., Benammi M., Tafforeau P., Duzer D., Moussa I., and Jaeger J.J. (2003), A Middle Miocene hominoid from Thailand and orangutan origins, *Nature*, **422**, 61.
- Chen J.Y., Bottjer D.J., Davidson E.H., Dornbos S.Q., Xiang Gao, Yong-Hua Yang, Chia-Wei Li, Gang Li, Xiu-Qiang Wang, Ding-Chang Xian, Hung-Jen Wu, Yeu-Kuang Hwu, and Tafforeau P. (2006), Phosphatized Polar Lobe-Forming Embryos from the Precambrian of Southwest China, *Science* **312**, 1644.
- Cloetens P., Mache R., Schlenker M., and Lerbs-Mache S. (2006), *Proc. National Acad. Sci. USA*, **103**, 14626.
- Helfen L., Baumbach T., Mikulik P., Pernot P., Kiel D., Cloetens P., and Baruchel J. (2005), High resolution three-dimensional imaging of flat objects by synchrotron-radiation computed laminography, *Appl. Phys. Lett.*, **86**, 071915.
- Tafforeau P., Boistel R., Boller E., Bravin A., Brunet M., Chaimanee Y., Cloetens P., Feist M., Hoszowska J., Jaeger J.-J., Kay R.F., Lazzari V., Marivaux L., Nel A., Nemoz C., Thibault X., Vignaud P., and Zabler S. (2006), Applications of X-ray synchrotron microtomography for non-destructive 3D studies of paleontological specimens, *Applied Physics A*, **83**, 195.

SFINX: Scanning Fluorescence and Imaging at the Nanoscale using X-rays

Summary

We propose the creation of a long, high brilliance beamline optimised for ultimate hard X-ray focusing. This intense nanoprobe will provide the ESRF imaging and analysis platform with unique high resolution capabilities for 3D imaging and fluorescence microanalysis. These developments will benefit mainly biomedical research and biomaterials science and will keep the ESRF at the forefront of X-ray imaging technologies.

Scientific case

Overview

Real space imaging is increasingly used as analytical method in the research fields of biomedicine, developmental biology, biomaterials science and functional morphology. While several nanoscale methods exist and are actively developed including modern variants of confocal microscopy and cryo-electron tomography, synchrotron radiation will have

a specific and crucial role to play. The main assets of hard X-ray imaging in this field are:

- The potential to combine high spatial resolution and reasonable sample thickness truly in three dimensions;
- The possibility to combine, on the same specimen, different imaging modalities such as phase contrast and fluorescence analysis;
- The feasibility of *in situ* experiments on specimens close to their native state and without modifying the sample nor making cumbersome preparation procedures;
- The possibility of following evolving biological systems with fast 2D and 3D imaging techniques.

Recent experiments using a 100 nm probe have provided the spatial resolution and elemental sensitivity needed to start original investigations on the role of trace metals in neurodegenerative diseases (Ortega *et al.*, 2007). Future directions in understanding trace elements homeostasis and interactions in the cells, their influence on protein structure and function (misfolding diseases) will require work on a dedicated nanoprobe setup in the sub 50 nm range with not more than a few thousand atoms to be detected and chemically identified.

The use of nanoparticles is expected to be the driving force for the emerging new materials industry and for novel approaches in health care through nanomedicine. Understanding the impact of these particles on human cells and tissues will be crucial for environmental safety reasons and for the reliable diagnosis and treatment of diseases.

Microtomography is an attractive and simple tool for studying the morphology and the function of complex biological systems (Betz *et al.*, 2007; Cloetens *et al.*, 2006). Nanoscale tomography will allow scientists to zoom in on the structure of tissues or cells close to their native state whilst keeping all the advantages of tomography data sets. Its impact will be very broad including applications in biomaterials, the structure and mineralisation of bone and arthropod cuticle and plant cell biology. In combination with fluorescence analysis for trace element characterisation, it will become possible to map the 3D distribution of specifically labelled molecules. An emerging area is the use of tomography to provide experimental data for computational biology.

Imaging in biology has an important fourth dimension: time. The observation of a cell or a tissue on a timescale comparable to the physiological events is a prerequisite in following biological processes. Fast 2D and 3D imaging techniques applied today on materials science problems (metal foams, annealing,...) or model systems (liquid foams) will become feasible at high resolution on wet tissues pending significant improvements in detector technology.

Techniques

The SFINX project will push existing techniques such as fluorescence analysis and projection microscopy to their limits in terms of spatial resolution and performance, but it will also be the cradle of novel high resolution X-ray imaging methods. It will be at the cutting edge in specific scientific domains and, in this way, complement the end-stations of the imaging and analysis platform (IMPACT, SMILE and XMAN) that provide high throughput parallel beam imaging, microspectroscopy, microdiffraction, etc.

Central to the approach is an intense ($> 10^{11}$ photons/s) nanoprobe with modest monochromaticity ($\sim 10^{-2}$) in the 15 to 25 keV range. Based on the ESRF experience in multilayer coated KB optics (Hignette *et al.*, 2005), a 2D focal spot size of 20 nm can be anticipated. This requires the extreme demagnifications and tuneable horizontal coherence offered by an ultra-long (~ 200 m) beamline on a high beta section. Smaller spot sizes could further be envisaged at a reduced photon flux.

Coherent imaging methods are still rapidly developing, but a unified picture is appearing (Nugent, 2007). Projection microscopy (Pereiro *et al.*, 2005) is a magnified version of holotomography, but can also be considered as coherent diffraction imaging with a curved wave front. It is particularly well adapted to dose sensitive specimens and provides morphological information by mapping quantitatively the distribution of the electron density. Combined with local tomography and laminography, it allows zooming into regions of interest selected within laterally extended samples, a unique and extremely important possibility in handling real scientific cases.

Nanoscale X-ray fluorescence imaging, combined online with density mapping, will provide quantitative maps of absolute concentrations of trace elements through fitting or simulation procedures in a fully self-consistent way. The extreme photon density in a nanofocused pink beam associated with new detection geometries will allow new milestones in detection limits to be reached, approaching the dream of single atom localisation (Bilderback and Huang, 2004).

Context with new sources and user community

Routine micrometre scale imaging techniques are available or planned at all synchrotron facilities. Furthermore, recent third-generation low energy sources (SLS, SOLEIL, BESSY II, ALBA) received support in developing facilities for nanoscale imaging through Fresnel zone plate based soft X-ray microscopy with the objective of a 30 nm spatial

resolution or lower. Still, the present proposal is unique by providing multimodal high flux and high energy nanoscopy. These properties will confer higher flexibility to tackle scientific cases relevant in nanomedicine, cellular metallochemistry and biomaterials science.

The SFINX project depends crucially on low emittance and high brilliance, therefore the competition from upcoming 1 nm emittance sources and new source concepts (energy recovery linacs) will be considerable, once constructed and operational.

This proposal strongly benefits from the acquired experience at ESRF and at INSERM (U-647: CHU Grenoble University Hospital) in X-ray fluorescence analysis, coherent imaging and nanofocusing applied to biomedical problems.

Technical considerations

The proposed nanoprobe imaging facility applied to a biological context is technically extremely challenging in terms of instrumentation, environmental control, optical devices, detector technology and sample environment.

Efficient focusing down to 20 nm 2D spot sizes will require a long beamline, exceeding 190 m; this is imposed by the ESRF vertical source size and the focal length of efficient focusing optics. A full length high beta section and associated horizontal secondary source are most adapted to compensate for the relatively poor emittance properties in the horizontal direction of the ESRF source. The proposed geometry assumes a 15 nm contribution to the spot size from the optics (such as diffraction limit, imperfections) and a working distance of 25 mm. To preserve the highest possible flux, the possibility of inserting elements as close as possible to the source (before the front end) would be highly beneficial.

Multilayer coated KB optics will be the main optics to provide an intense, pink nanoprobe. As the wave front quality plays a major role in coherent imaging, improved surface finishing methods have to be developed. Other optics can be envisaged to provide smaller, but much less intense beams.

The infrastructure should be optimised to minimise the influence of all external perturbations (mechanical vibrations, temperature changes, etc.). The number of human interventions should be reduced to an absolute minimum in this context. The microscope should therefore be completely remotely controlled. This will also open the possibility of distant access to the imaging facility (tele-nanoscopy).

Radiation damage is the ultimate limitation in high resolution imaging; therefore all radiation emerging from the sample should possibly be detected and analysed. Multiple detector environments with the highest possible efficiency and speed will have to be implemented to provide dose limited chemical imaging. A 20 micron area (cell size) scan at 0.1 micron spatial resolution and 100 ms dwell time requires a bit more than 1 hour, and would require 27 hours to probe it with a 20 nm pitch. Keeping the possibility of characterising at the nanoscale relatively large areas (10 to 20 microns) of a sample is nearly impossible by any other technique, providing a unique possibility to the user communities.

In the same context, an integrated environment for studying cryo-fixed samples has to be developed. It should be compatible with high resolution imaging and tomography. This should be coupled to a nearby dedicated common platform for sample preparation.

Support facilities

A sample preparation laboratory shared with other beamlines should be foreseen. The characterisation and preparation methods should include confocal microscopy, SEM/FIB and a fast high pressure freezing device.

3D/4D imaging in general, and coherent imaging in particular, requires huge computing resources. Preserving a useful field of view at a much finer resolution will significantly increase the size of the individual data sets. This problem should be addressed by an adapted centralised infrastructure. Grid technology will be crucial for data processing and tele-microscopy.

References

- Betz O., Wegst U., Weide D., Heethoff M., Helfen L., Lee W.-K., and Cloetens P. (2007), Imaging applications of Synchrotron X-ray micro-tomography in biological morphology and biomaterial science, *J. Microscopy*, **227**, 51.
- Bilderback D.H. and Huang R. (2004), Are Atom-sized X-ray Experiments Possible?, *AIP Conference Proceedings*, **705**, 1271.
- Cloetens P., Mache R., Schlenker M., and Lerbs-Mache S. (2006). Quantitative phase tomography of Arabidopsis seeds reveals intercellular void network, *Proc. Nat. Acad. Sci. USA*, **103**, 14626.
- Hignette O., Cloetens P., Rostaing G., Bernard P., and Morawe C. (2005), Efficient sub 100 nm focusing of hard x rays, *Rev. Sci. Instrum.* **76**, 063709; http://www.esrf.eu/news/spotlight/spotlight24_40nm 40 nm focus reached at the ESRF using dynamically-bent graded multilayers.
- Nugent K.A. (2007), X-ray noninterferometric phase imaging: a unified picture, *J. Opt. Soc. Am. A*, **24**, 536-547.
- Ortega R., Cloetens P., Devès G., Carmona A., and

- Bohic S. (2007), Iron Storage in Dopamine Vesicles Revealed by X-ray Nanochemical Imaging, submitted.
- Pereiro E., Ludwig W., Bellet D., Cloetens P., and Lemaignan C. (2005), Direct evidence of nanometric invasionlike grain boundary penetration in the Al/Ga system. *Phys. Rev. Lett.*, **95**, 215501.

SMILE: Spectro-Microscopy and Imaging at Low Energies and XMAN: X-ray Spectroscopy Multi-Imaging Analysis

Summary

The upgrade programme of the two X-ray microprobe beamlines (currently ID21 and ID22) aims at best exploiting the new possibilities offered by the ESRF Upgrade context: smaller probes, larger working distances and improved infrastructure. It is not only proposed to extend the intrinsic capabilities of the instruments, in terms of spatial resolution and detection limits but also to further develop a multimodal analysis platform based on the use of infrared and X-ray microspectroscopies, microdiffraction, and X-ray imaging techniques. This technique portfolio should be completed by electron and Raman microscopes. Emphasis will be given to 2D and 3D chemical mappings and *in situ* experiments. The programme will involve:
SMILE (current ID21): spectro-microscopy and imaging at low energies for chemical mapping in the multi-keV range (2 to 10 keV) and mid-infrared spectral range (1 to 20 μm).
XMAN (current ID22): "X-ray multi-analysis nanoprobe" for multimodal X-ray micro- and nano-analysis in the hard X-ray energy range (6 to 60 keV).

Scientific case

Overview

Microanalytical techniques aim at screening samples at various levels of information, ranging from elemental, chemical and structural data. Most natural or man made systems have properties that depend on the specific hierarchy of chemical components, and their organisation at different length scales. Therefore, an understanding of macroscopic function requires insights of microscopic structure and dynamics on all length scales down to the molecular and atomic levels. Ultimately, these investigations must address *in situ* studies of realistic systems. Specific behaviours such as phase transitions,

dynamics, reactions, simulated manufacturing conditions, deformation and damage, and environmental consequences are then accessible.

The above considerations underpin the requirements for a multimodal approach, where several analytical techniques are needed to bridge the gap from a macroscopic function to its atomic or molecular origins by probing chemical and structural information at various length scales. In a more specific context, X-ray microanalysis techniques nowadays follow the evident trend in the development of nanotechnologies by pushing spatial resolution further down to the nanoscale. Towards this perspective, synchrotron based analytical techniques (diffraction, imaging and microspectroscopies) will play an important role by offering unique capabilities in the study of complex systems.

Both by extrapolation of the experience gained in the soft X-ray regime and by the development of new techniques, "hard" X-ray microscopes nowadays offer a unique analytical tool which contributes to a wide range of existing and new applications of X-ray microscopy in experimental research fields such as materials science, medicine, geology, archaeology, Earth, planetary and environmental sciences. Compared to other techniques, synchrotron X-ray fluorescence microprobes display a unique combination of features. Associated with high detection efficiency, radiation damage is minimised and accurate quantification is possible. Furthermore, the possibility of *in situ* experiments remains a unique attribute of synchrotron based analytical methods. Photon depth penetration of hard X-rays enables specific sample environments to study realistic systems in their near-native environment rather than model systems. The ability to perform *in situ* analysis with controlled environments offering high or low temperature conditions, high pressure, or preserving sample hydration explains the increasing interest from various communities such as planetary and Earth sciences, environmental science and microbiology. Finally, the need for combined morphological and chemical information is a clear trend, which is steering our strategy toward a coupled access to full field sub-micrometre imaging and microprobe based spectroscopy (IR, XEOL and X-rays).

Although the ID21 and ID22 beamlines are currently covering a very broad range of disciplines, the envisaged improvements aim to specifically impact upon fields in which X-ray spectroscopy at sub-micron resolution is required. An important aspect of our strategy will be reinforced, namely the multimodal analysis approach combining several methods, as available on both beamlines, including XRF, XANES, XRD, XEOL and FTIR in both two and three dimensions. Hereafter, four scientific cases are developed to exemplify the new avenues offered by SMILE and XMAN.

i) Role of metals in Biology and Medicine:

"...Improvements of microscopic and spectroscopic techniques towards ultra high spatial resolution will provide a better understanding of the cell's complex "machinery" in basic research..." from "Vision Paper and Basis for Strategic Research Agenda for NanoMedicine", European Technology Platform on NanoMedicine, 2005.

"...Empirical evidence for the utility of metal-based therapeutics has existed for centuries; theoretical understanding is bound to follow..." from Thompson and Orvig (2003).

Metal ions play a multifold role in numerous cellular regulatory processes and can promote responses that range from deficiency to toxicity. Several families of proteins control the activity of intracellular metal ions and confine them to vital roles. These include integral transmembrane transporters, metalloregulatory sensors and cytoplasmic metallochaperone proteins that protect and guide metal ions to targets (Finney and O'Halloran, 2003). Associated with the low detection limit of XRF techniques, the improvement of the spatial resolution down to 50 nm will open new analytical possibilities at the sub-cellular scale. Two generic examples are developed hereafter to illustrate the potential impact of our microanalysis platform: Firstly, metals are known to play a major role in carcinogenesis and in the development of neuro-degenerative diseases. For instance, the etiology of Alzheimer's disease is still unclear but protein aggregation, oxidative stress and disturbances in energy metabolism have all been implicated. The main hallmark of this disease is the deposition of aggregated protein plaques in the brain and localised accumulation of metals. In all of these processes metal ions are suspected to play a role, not only in terms of abnormal accumulation but also in their changes of coordination.

Secondly, research for the delivery and targeting of pharmaceutical, therapeutic and diagnostic agents is at the forefront of projects in nanomedicine⁽ⁱ⁾. Much effort is being used to identify precise cellular targets related to specific clinical cases. Concomitantly, more and more ingenious strategies are developed to build appropriate nanocarriers to achieve the targeted responses whilst minimising the side effects. All of these technologies often require various nanomaterials like some nanosized particles (TiO₂, ZnO, Au, CisPt,...). The targeting specificity of such metal complexes remains a key-issue which must be checked at the sub-cellular level. In addition, the cytotoxicity of nanoparticles or their degradation products remains a major problem and improvements in biocompatibility obviously are a main concern for future research. One of the challenges of designing metal based drugs is to balance the potential toxicity of an active formulation with the substantial positive impact. Again, dose and chemical speciation appear to be the key information.

In the two scientific cases above, the combination of FTIR and X-ray fluorescence nanoprobe (soft and

hard X-rays) is expected to contribute to these cutting edge developments by giving access to the three key parameters of spatial distribution (localisation), concentration (dose) and chemical state (coordination) and enabling a better understanding of the altered processes occurring at different stages of the diseases. This unique coupling high resolution/high detection efficiency/spectroscopy is also extremely promising for the study of the interaction of trace metals with various specific cellular compartments. Owing to an extensive research and development programme on the cryo-preservation of the sample during data acquisition, X-ray fluorescence nanoprobe will appear as a unique analytical technique with the spatial resolution to examine intact hydrated samples at the nanometre scale and that are capable of both imaging and chemical determinations (Kemner *et al.*, 2004).

ii) Nano-XEOL analysis of confined light emitting semiconductors:

"...For semiconductor materials, functional properties tend to be less sensitive to the exact number of constituent atoms: desired quantum effects already arise for structures with dimensions of 10–100 nm and containing somewhere between 10^3 and 10^6 atoms in a crystalline lattice.... Still, quantum dots are very much solid-state nanostructures, and their energy spectrum, which controls many of the physical properties of interest, can be adjusted over a wide range by tuning composition, size, lattice strain and morphology..." from J. V. Barth *et al.* (2005).

The recent development trend of optoelectronic devices towards nanotechnology will imply new optical analytical tools with site selectivity at the atomic level (Sham *et al.*, 1993). Structural defects at the nanoscale, such as local lattice distortions, point defects and dopant positions, determine the quantum confinement effects, electronic state fluctuations and, consequently, the optical efficiency. So far, these properties have been studied separately by various analytical methods. However, a complete understanding of the quantum effects requires the study of the physical relationship between local atomic coordination and the related electronic properties. Today, there are no analytical tools allowing simultaneous access to both sets of information at the nanoscale.

ID22 pioneered the combined use of X-ray excited optical luminescence (XEOL) and an X-ray microbeam to probe the site selectivity of optical centres. The site selectivity is based on inner shell excitations (X-ray absorption spectroscopy) and detection of the induced recombinations of electron-hole pairs (XEOL) (Zhang *et al.*, 2002). Although the feasibility of this approach has been demonstrated (Martinez-Criado *et al.*, 2006), it is currently limited by the lateral resolution of the X-ray probe. The migration of this XEOL spectrometer to a new nanoprobe will allow access to the properties of single

quantum structures and will provide unique information on non-linear phenomena, emitting processes, role of excitons and polaritons on the optical properties of the emitting channels. Ultimately, XEOL 2D-maps can be reordered together with elemental maps to correlate light emission with composition.

iii) Extraterrestrial materials:

"...The best available instruments and methods on the planet were used in this study, and it is expected that additional studies coupled with advances in analytical capabilities will continue to reveal important secrets about the origin and evolution of the solar system ...", from Brownlee *et al.* (2006).

The ID22 and ID21 microprobes have been already successfully used for the study of meteorite grains, interplanetary dust particles. For instance, the STARDUST mission (NASA, January 2006) collected the first samples of cometary and contemporary interstellar dusts to be analysed in laboratory. The grains were trapped in "aerogel" collectors and their analyses required high spatial resolution and non-invasive techniques. This non-destructive identification of the material distributed inside the aerogel can be made using synchrotron X-rays microbeams either in fluorescence or absorption modes. Such techniques are particularly well adapted since the incident X-rays, at energies of a few keV, can be focused a few millimetres inside a collector. Today, synchrotron based microprobes remain, amongst all "non-destructive techniques", the best possibility for *in situ* high resolution and non-invasive analysis of micron sized grains trapped in such collectors. However, there is still room for major improvements:

On one hand, those materials are often described as highly heterogeneous aggregates of basic entities of sub-micron size grains, particles or nanocomposites. Furthermore, recent analysis confirmed that the most interesting - and rare - samples collected during the STARDUST program exhibit a typical micron size (Baker, 2006). So far, the limited spatial resolution does not allow analysis of single grains, with information therefore today averaged over clusters or conglomerates. The upgraded microprobe with 50 nm resolution will allow single particles to be analysed. On the other hand, several other missions (*e.g.* MARS mission) are anticipated and most of the samples will be conditioned in containers. The proposed new fluorescence microprobe with larger working distance is again very well suited to the study of grains in quarantine conditions, confined in a sealed container. Finally, the combination of XANES, XRD and FTIR has a high scientific potential and constitutes the most attractive approach for the space community. Such a multimodal approach will provide morphological, mineralogical or compositional information of single grains and at the interface between grains. This makes not only a complete

description of cometary grains possible, but also gives insights of their extraterrestrial origin, the history of their formation and of the thermal interactions during their slowing down in the aerogel collectors.

iv) In vivo monitoring of microbial respiration in extreme environments:

"Extremophile research is entering an exciting phase... Our ignorance of microbial diversity coupled with improvements in exploration and analytical technology suggest that many more major discoveries will be forthcoming..." from Rothschild and Mancinelli (2001).

Microbial life thriving in extreme environments is adapted to harsh physical (for example temperature, radiation or pressure) or geochemical conditions (for example desiccation, salinity, pH, oxygen species or redox potential) by their physiological and nutritional requirements. Due to their appeal as models of primitive life forms and as sources of outstanding biomolecules useful in both fundamental and applied research, studies on extremophilic organisms have intensified in the last decade.

For instance, the energy metabolism of prokaryotes under extreme conditions is based upon a wide range of oxido-reduction reactions involving metallic compounds. The understanding of these respiration processes is hampered by the lack of direct access to *in vivo* processes. Challenges posed by extreme habitats include their remote nature, harsh conditions and inaccessibility. As successfully demonstrated by associating diamond anvil cell (DAC) technology with Raman spectroscopy (Sharma *et al.*, 2002), there is a real scientific potential for new methodologies to study extremophile metabolism. A dedicated programme, including the development of a dedicated DAC to simulate extreme conditions in terms of temperature, metal concentrations and anaerobiosis, will exploit the unique capabilities of X-ray microspectroscopy in terms of lateral resolution, detection limit and chemical information. In this context, monitoring of redox reactions can be envisioned at the level of a single organism. Access to the absorption edges of sulphur and metals together with FTIR microspectroscopy offers a unique combination in this field of research.

Techniques

SMILE and XMAN are built into a multi-modal framework and aim to offer an ensemble of complementary sets of information by using the following techniques:

- X-ray fluorescence (XRF)
- X-ray absorption spectroscopy (XANES and EXAFS)
- X-ray diffraction (XRD)
- X-ray excited optical luminescence (XEOL)
- Computed tomography in various contrast modes (absorption, phase and X-ray fluorescence)

Context with new sources and user community

All X-ray analysis techniques are currently following the obvious trends in the development of nanotechnologies by pushing down spatial resolutions. Considering the simultaneous developments of laboratory instruments and dedicated synchrotron beamlines worldwide, a very competitive context can be anticipated for the coming years. Some projects are expected to be highly competitive (SLS, SOLEIL, DIAMOND, APS, and PETRA-III) and should target the same user communities. However, our concept of a coordinated access to several instruments within a multi-analytical platform will remain unique and must be very appealing for users.

Technical considerations

SMILE: The technical development of the beamline will be articulated around experience gained on the X-ray microscopy beamline (ID21) over the past few years.

- Source: A low-beta straight section offers the best characteristics (in particular the horizontal source size) for high source demagnification. *In situ* experiments will benefit from the long working distances made possible by extending the beamline length.
- Optics: Nanoprobes will be achieved with both KB mirrors and/or Fresnel zone plates. Efficient harmonic rejection will be necessary.
- End-station: The end-station will be located at approximately 90 m from the source and will provide both monochromatic ($\Delta E/E \sim 10^{-4}$ to 10^{-5}) and pink beams ($\Delta E/E \sim 10^{-2}$). The microscope will be operated under vacuum and will cover an energy range of 2 to 7 keV.
- FTIR end-station: Based on the existing instrument, a specific effort has to be made to exploit the synergy with X-rays. In particular common sample environments have to be developed.

XMAN: The project aims to develop a two end-station beamline providing a multi-analysis instrument with lateral resolution ranging from 500 μm to 50 nm.

- Source: A high-beta straight section associated with a horizontal secondary source aperture will offer the best flexibility by tuning the photon flux/spatial resolution ratio matching various experimental requirements. The targeted 50 nm lateral resolution combined with long working distances for *in situ* environments requires a beamline length of about 100 m.
- Optics: The nanoprobes will be achieved with both KB mirrors and KB multilayers. Harmonic rejection has to be considered.
- End-station 1: This multi-purpose end-station will

be located at approximately 60 m from the source with the following attributes:

- Tunable monochromatic beam ($\Delta E/E \sim 10^{-4}$ to 10^{-5}), micron range spatial resolution, very high flux. A degree of flexibility will be necessary to accommodate *in situ* experiments associated with the combination of various techniques on the same instrument.

- Quasi-monochromatic mode (pink beam plus multilayer KB) with sub-micron spatial resolution (150 nm), a very high flux but with short working distances (a few cm). This configuration will be dedicated to fast 2D and 3D X-ray fluorescence mappings.

- End-station 2: This end-station will be located at approximately 100 m from the source and will be dedicated to high lateral resolution spectro-microscopy combined with XRF mapping. It will provide the same characteristic of EH1 but with unproved lateral resolution: it will operate in monochromatic mode ($\Delta E/E \sim 10^{-4}$) and will be specifically equipped to accommodate biological samples (integrated cryogenic sample cooling). In this context, long working distances and spatial resolution of at least 50 nm will be required. A combination of techniques will also be available; in particular high-resolution XEOL will be implemented.

The development of such nanoprobe beamlines is extremely challenging. Specific research and development programmes and related implementations of cutting edge instrumentation will be required in many different fields:

- High quality fixed exit monochromator will be required for X-ray nanospectroscopy measurements with a 100 nm lateral resolution.
- Multi-element detectors with large solid angles, high efficiencies and high speed data collection have to be implemented.
- Active monitoring systems for sample, optics and beam positioning have to be developed for a full real time control of the beamline stability.
- A cryogenic sample environment compatible with the specific nanoprobe geometry has to be developed.

Support facilities

The development of a dedicated laboratory for both sample preparation and sample inspection and visualisation will be of major importance for a successful development of this programme. Ancillary equipments such as electron and visible light microscopes, FTIR and Raman spectro-microscopes and sectioning/polishing apparatus are mandatory. This laboratory can be shared with other beamlines requiring similar instruments and equipment (*e.g.* EDXAS-S, SFINX, IMPACT).

References

- Baker J. (2006), Look into the seeds of time, *Science*, **314**,

1707.

- Barth J.V., Costanini G, and Kern K. (2005), Engineering atomic and molecular nanostructures at surfaces, *Nature*, **437**, 671-679.
- Brownlee, D. *et al.* (2006), Comet 81P/Wild 2 Under a Microscope, *Science*, **314**, 1711.
- Finney L. A. and O'Halloran T. V. (2003), Transition Metal Speciation in the Cell: Insights from the Chemistry of Metal Ion Receptors, *Science*, **300**, 931.
- Kemner K. M., Kelly S. D., Lai B, Maser J., O'Loughlin E. J., Sholto-Douglas D., Cai Z., Schneegurt M. A., Kulpa C. F. and Neelson K. H. (2004), Elemental and Redox Analysis of Single Bacterial Cells by X-ray Microbeam Analysis, *Science*, **306**, 686.
- Martinez-Criado G, Alen B., Homs A., Somogyi A., Miskys C., Susini J., Pereira Lachataigneris J. and Martinez-Pastor J. (2006), Scanning X-ray excited optical luminescence microscopy in GaN, *Appl. Phys. Lett.* **89**, 221913.
- Rothschild L.J. and Mancinelli R.L. (2001), Life in extreme environments, *Nature*, **409**, 1092-1101.
- Sham T. K., Jiang D. T., Coulthard I., Lorimer J. W., Feng X. H., Tan K.H., Frigo S. P., Rosenberg R. A., Houghton D. C. and Bryskiewicz B. (1993), Origin of luminescence from porous silicon deduced by synchrotron-light-induced optical luminescence, *Nature*, **363**, 331.
- Sharma A., Scott J. H., Cody G. D., M. L., Fogel, Hazen R. M., Hemley R. J. and Huntress W.T. (2002), Microbial Activity at Gigapascal Pressures, *Science*, **295**, 1514.
- Thompson K. H. and Orvig C. (2003), Boon and Bane of Metal Ions in Medicine, *Science*, **300**, 936-939.
- Zhang P., Kim P. S., and Sham P. S. (2002), Nanostructured CdS prepared on porous silicon substrate: Structure, electronic, and optical properties, *J. Appl. Phys.*, **91**, 6038.

(i) Applications of nanotechnology for treatment, diagnosis, monitoring, and control of biological systems have recently been referred to as "nanomedicine" by the National Institutes of Health.



The European Light Source

ESRF SCIENCE AND TECHNOLOGY PROGRAMME 2008-2017

ANNEXE II

Safety

Safety considerations for operation at 300 mA stored current

The impact of the increased storage ring current has been evaluated in the framework of the existing ESRF radiation protection policy, which is detailed in the authorisation given by the official French body, the *Autorité de la Sûreté Nucléaire* (ASN), formerly *Direction Générale de la Sûreté Nucléaire et de la Radioprotection* (DGSNR).

This specifies that all people working at the ESRF shall be considered as non-radiation workers, by guaranteeing the derived four hours dose limit for non-exposed workers in all areas which are accessible during operation. This is expressed by the formula:

$$\int_0^t \dot{H} \cdot dt \leq 4 \text{ hours} \times 0.5 \mu\text{Sv/h} = 2 \mu\text{Sv}, \quad t \leq 4 \text{ hours}$$

It has been demonstrated that the present shielding of the storage ring, as well as that of the beamlines, will allow for safe operation at 300 mA.

Given the anticipated storage ring upgrade, the shielding of the storage ring tunnel was extensively reinforced a few years ago. The improvements were verified by using a stored beam current of 300 mA during a test shift on 12th December 2006. These measurements confirmed the effectiveness of the shielding upgrade: all dose rates measured outside the storage ring tunnel walls and roof were well below the derived limit of 0.5 $\mu\text{Sv/h}$.

The shielding requirements for the optics enclosures of insertion device (ID) beamlines at the ESRF are essentially defined by scattered gas-bremsstrahlung photons and gas-bremsstrahlung induced neutrons. Gas-bremsstrahlung is generated by the interaction between the electron beam and the residual gas molecules inside the vacuum chamber. The power P of the gas-bremsstrahlung entering the optics hutch can be written as:

$$P \propto E_e^2 \times I^2 \times L$$

The gas-bremsstrahlung, which is proportional to the square of the electron energy E_e , is of particular importance for high-energy storage rings. Parameter L represents the total length of the straight section from dipole to dipole, including the part used for insertion devices (5 or 7 metres). When the stored beam current goes up from 200 to 300 mA, the gas-bremsstrahlung power, and hence the radiation levels outside the ID optics hutches, are therefore expected to increase by a factor of $(3/2)^2 = 2.25$.

During the last decade, much effort has been put into improving the dynamic vacuum levels in the storage

ring straight sections. These endeavours were triggered off by the problematic increase in the radiation levels measured outside optics hutches, linked to the installation of the first small-gap insertion device vacuum vessels. This has notably led to the development of a vacuum-vessel coating method known as non-evaporable getter (NEG), which is now applied systematically to all new ID vacuum vessels. A policy for the installation of such vacuum vessels has also been devised, including their pre-conditioning on the dedicated ID30 straight section, and their validation in terms of bremsstrahlung production. These combined efforts have meant that, after vacuum interventions on the corresponding straight section of the storage ring, beamline downtime due to radiation constraints can be kept to just a few days at the most.

Figure II.1 illustrates the radiological situation of a typical insertion device beamline. Data were taken outside the optics hutch of the ID12 beamlines during the last experimental run of 2006, following a vacuum intervention in cell 12 during the preceding shut down. The top part of the figure shows the photon and neutron ambient dose equivalents, measured outside the side wall of the optics hutch. A total (net) photon ambient dose equivalent of 50 μSv , and a total neutron ambient dose equivalent of 90 μSv , are integrated over the 50 days of the experimental run. Since these values are induced by gas-bremsstrahlung produced in the straight section, these integrated dose values can be compared with the product of the stored beam current and the straight section pressure, integrated during user operation time (USM). For this beamline, the following dose production rates are therefore obtained:

| | |
|-----------|--|
| Photons: | $1.9 \times 10^5 \mu\text{Sv/h/mA/mbar}$ |
| Neutrons: | $3.4 \times 10^5 \mu\text{Sv/h/mA/mbar}$ |
| Total: | $5.3 \times 10^5 \mu\text{Sv/h/mA/mbar}$ |

At 300 mA the beamline will therefore be able to operate at maximum pressures of the order of 3×10^{-9} mbar, thereby respecting the present ESRF radiation protection policy (average dose rates < 0.5 $\mu\text{Sv/h}$).

This example, typical of ID beamlines at the ESRF, shows that with the present NEG coating vacuum technology, and the vacuum vessel installation policy (pre-conditioning of ID vessels), the operation of the ID beamlines at 300 mA stored beam will be compatible with our radiation protection policy. Note that the gas-bremsstrahlung produced in straight sections equipped with in-vacuum undulators is relatively lower, thanks to more efficient pumping.

The shielding of the bending magnet beamlines is entirely determined by scattered synchrotron radiation. The radiation levels outside these hutches

are therefore expected to increase by a factor of 1.5 when the current goes up from 200 to 300 mA. The existing hutches will be able to cope with this

increase, in line with the ESRF radiation protection policy, with the possible exception of some very local shielding reinforcements.

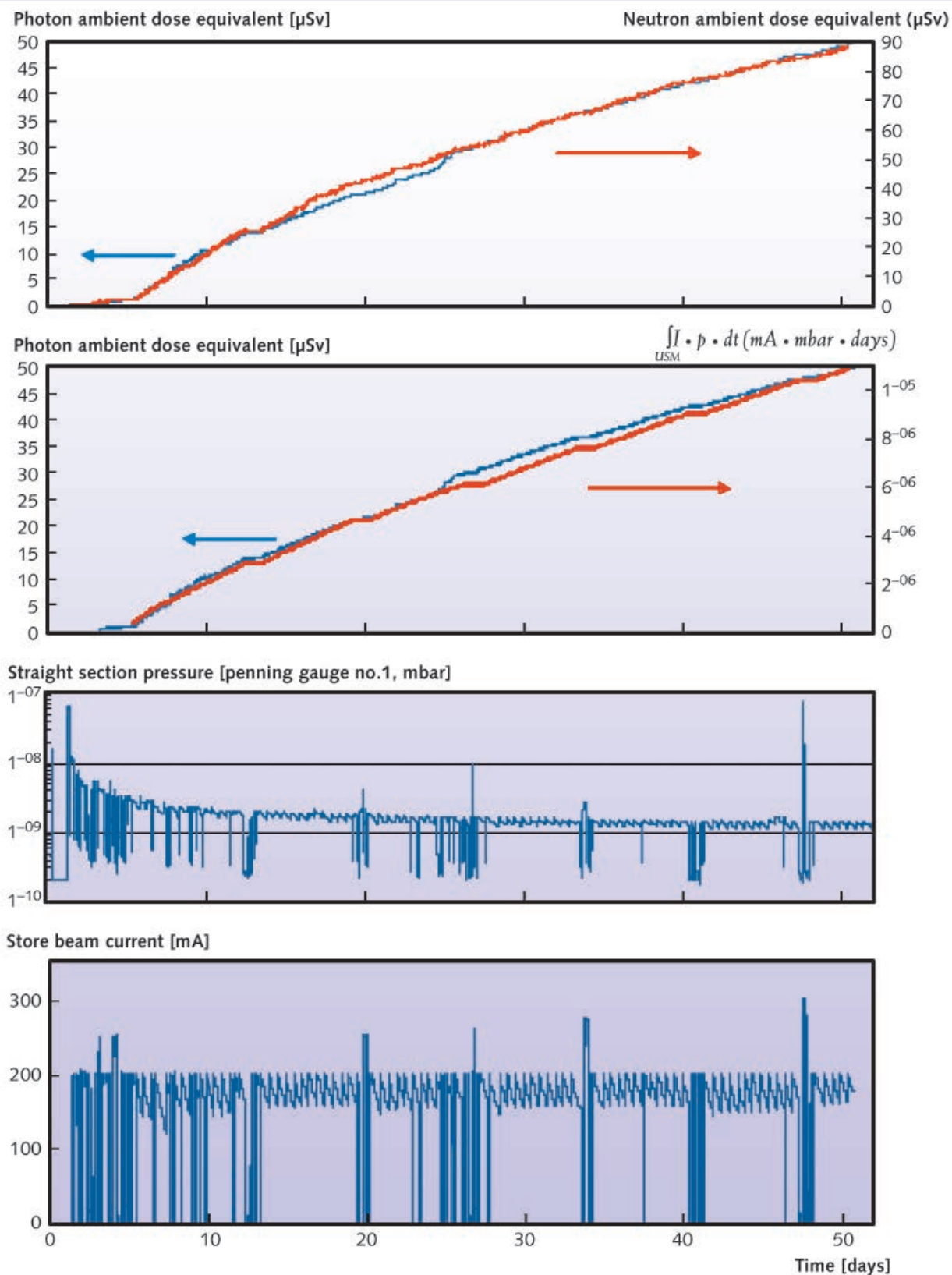

Figure II.1: Ambient dose equivalent measurements outside the optics hutch of beamline ID12 during run 2006-05. *Top:* photon (blue curve) and neutron (red curve) ambient dose equivalents. *Second from top:* photon (blue curve) and time integrated value of store current \times straight section pressure (red curve). *Second from bottom:* pressure reading from the first penning gauge of cell 12, representative of the pressure in the straight section. *Bottom:* stored beam current.



The European Light Source

ESRF SCIENCE AND TECHNOLOGY PROGRAMME 2008-2017

ANNEXE III

Other Synchrotrons

Other synchrotron facilities in Europe and those comparable to the ESRF worldwide (APS and SPRING-8)

This is a period of remarkable change and development for synchrotron radiation science in Europe and across the world. A large number of third-generation sources are operating or are under construction, while several advanced free-electron laser projects are in the planning or realisation phase.

In this annexe, the proposed Upgrade Programme for the ESRF is placed in the context of the rapidly evolving European and world synchrotron radiation scene. The information has been derived from the different facility web sites, supplemented by direct contact where necessary.

It is important to note that several of the ESRF's Member and Associate countries do not possess national level light source facilities: the ESRF is their principal resource. Consequently, the ESRF's portfolio of beamlines must complement those available on national sources, particularly where harder X-rays are concerned, but must also provide a reasonable coverage of all fields required by those member nations without their own national facilities.

Finally, the only other two synchrotrons in the world that are comparable with the ESRF – the Advanced Photon Source (APS) in the USA, and SPRING-8 in Japan – also have their own upgrade plans and the same desire to remain state-of-the-art facilities for modern science.

A full list of world light sources is available at <http://www.lightsources.org>.

III.1. Other European synchrotron facilities

III.1.1. ALBA, Spain (under construction)

<http://www.cells.es/>

ALBA is a third-generation, 3 GeV synchrotron radiation facility being built near Barcelona. Co-financed by the Spanish and Catalan governments, ALBA has a design value for the horizontal emittance of around 4 nmrad. The current staff of 109 engineers, scientists, support staff and technicians will grow to about 140 people and will welcome scientists from all over the world. The commissioning is planned for 2009, while the operation of an initial portfolio of seven beamlines is scheduled for 2010.

All but one of the seven beamlines will receive their photons from insertion devices. Two wiggler beamlines will provide hard X-rays of up to more than 60 keV for experiments using X-ray absorption and high-resolution powder diffraction (including high-pressure capabilities). Two more experimental stations for protein crystallography and non-crystalline diffraction/scattering will receive their photons from small gap, in-vacuum undulators.

For polarisation-dependent experiments in the energy range of up to several keV, two helical undulator beamlines are planned, providing facilities for XMCD (X-ray magnetic circular dichroism), XMLD (linear dichroism) and resonant soft X-ray scattering, as well as photoemission microscopy (PEEM) and photoemission under near ambient pressure (NAPP).

Finally, a bending magnet beamline with X-ray energies up to 3000 eV is planned for full field X-ray imaging of biological samples.

III.1.2. ANKA, Germany

<http://ankaweb.fzk.de/>

ANKA is a synchrotron radiation facility implanted in the scientific infrastructure of the Forschungszentrum Karlsruhe in Germany. The storage ring is operated at 2.5 GeV, with 12 dipole magnet beamlines covering the soft to medium X-ray energy range (including an infrared beamline). In addition, one superconducting wiggler beamline is operational.

ANKA is open to both scientific and commercial users who have access to synchrotron radiation in the fields of condensed matter, nano- and micro-technologies, environmental (actinide) studies, and research in synchrotron technology and

instrumentation. The facility has acquired a high level of competence in accelerator and superconducting undulator technology, deep X-ray lithography, infrared and X-ray spectroscopy, as well as scattering and imaging, which enables it to furnish scientific services in the fields of analytics, the characterisation of materials, and microfabrication.

As a large-scale facility in the German Helmholtz Association of National Research Centres, ANKA conducts a strong in-house research programme, enabling nanostructure materials, hydrogen storage materials, and self-assembling processes, among others, to be investigated. Since its inception, the facility has pioneered a number of synchrotron technology developments such as planar superconducting undulators, X-ray lenses, and infrared edge radiation, a technique used with great success to observe stable coherent infrared radiation in the terahertz region with unprecedented photon flux.

Over the past two years, more than 50% of the available beam time has been allocated to external users, the key partners being MPI-MF and MPI-FKF (Max-Planck Institutes for Metal and Solid State Research), the Centre for Functional Nanostructures (Karlsruhe, Germany), as well as local universities.

Plans for the future include a new infrared beamline for the condensed matter programme, and a dipole magnet beamline for actinide research. The facility's instrumental development programme will focus on superconducting short-period undulators as well as a planar helical undulator to produce soft X-rays with variable polarisation. Devices combining the functionality of an undulator (tuneable wavelength and high brilliance) with those of a wiggler (continuous spectrum up to 100 keV at ANKA's ring energy) will be installed on new beamlines dedicated to nanosciences and imaging, and currently under construction.

III.1.3. BESSY, Germany

<http://www.bessy.de/>

The Berliner Elektronenspeicherring-Gesellschaft für Synchrotronstrahlung, or BESSY, operates the only third-generation synchrotron radiation facility in Germany, a position which will change with the advent of PETRA-III (cf. section III.1.4 below). The BESSY-II storage ring, operational since 1998, runs at 1.7 GeV and hosts around 50 beam ports with wiggler, undulator and dipole magnet beamlines, mainly providing radiation within the infrared, VUV, XUV and soft X-ray energy ranges.

BESSY's general profile is largely determined by more than 1300 national and international users, including

its important institutional users: the Hahn-Meitner-Institute, the Max-Planck-Association, the German Federal Agency for Materials Research and Testing, and the German Federal Physical Technical Agency (Physikalisch Technische Bundesanstalt PTB) which runs eight experimental stations. BESSY is financed by public funding as well as by beam time fees paid by the users.

The beamline portfolio consists of 49 experimental stations, roughly half of them being operated (and mainly used) by collaborating research groups (CRG) from BESSY's aforementioned institutional partners. The experimental techniques offered on the beamlines cover the major areas of modern synchrotron radiation-based research. Permanent experimental stations are available for terahertz and infrared spectroscopy, ellipsometry and microscopy, a large variety of ultraviolet and soft X-ray photoemission techniques (UPS, XPS, PEEM), reflectometry, X-ray microscopy, ultraviolet and X-ray lithography, and resonant magnetic scattering.

BESSY's in-house activities are manifold, ranging from accelerator development, the design and calibration of measuring instruments for physical sciences, to all aspects of the application of synchrotron radiation. Emphasis is placed on the investigation of semiconductor materials, thin magnetic layers, structural biology, as well as micro- and nanotechnology.

BESSY aims to extend its activities towards fourth-generation synchrotron radiation sources. To cover its traditional spectral range from ultraviolet to soft X-rays, BESSY proposes to build a ~400 m long free electron laser (FEL) next to the present synchrotron radiation source. The project was reviewed favourably in 2006 by the German Science Council, who advocated the construction of a smaller FEL first in order to satisfactorily demonstrate the working principles.

III.1.4. DESY, Germany

<http://www.desy.de/>

The Hamburg Synchrotron Laboratory (HASYLAB) at the Deutsches Elektronen-Synchrotron (DESY) in Hamburg, Germany, has provided synchrotron radiation to users since the 1970s. The first storage ring at DESY was DORIS, known today as DORIS III, after its third conversion. A second-generation storage ring operating at 4.5 GeV, it serves as a synchrotron light source for HASYLAB and a large national and international user community. DORIS III hosts a total of 36 beamlines (10 of which are installed on insertion devices), delivering radiation to about 44 instruments.

With the exception of infrared spectroscopy, all varieties of modern synchrotron radiation-related research are represented at DORIS III, ranging from materials science, life sciences and soft condensed matter research to nanosciences. Most experimental techniques commonly used nowadays are offered to the users: X-ray absorption, scattering and diffraction techniques of all kinds, as well as tomographic imaging. An outstation of the European Molecular Biology Laboratory (EMBL) operates several bending magnet and insertion device beamlines for structural biology applications, whilst the Max-Planck Research Unit for structural molecular biology, and the Helmholtz Research Centre GKSS, both operate one further wiggler beamline.

In order to meet the user demand for smaller and more intense beams, a high brilliance synchrotron radiation source is under construction at DESY. By using one-eighth of its circumference for insertion devices, the present 12 GeV storage ring PETRA II (used as the booster for the HERA high-energy physics storage ring up to June 2007) will be transformed into a third-generation source called PETRA III, running at 6 GeV with a 1 nmrad horizontal emittance, and hosting 14 high brilliance undulator beamlines. The start of user operation is planned for 2009. The portfolio of experiments proposed includes beamlines dedicated to hard X-ray scattering and materials science in general, nanosciences (tomography and microprobe, imaging), high resolution diffraction, coherence applications, and resonant scattering and diffraction. An XUV beamline will operate in the energy range of 250 to 3000 eV mainly for spectroscopy applications, making use of the almost complete circular polarisation of the beam. Four beamline proposals will be dedicated to life sciences (biological imaging, small angle scattering and macromolecular crystallography).

It was DESY who built the first free electron laser for VUV and soft X-ray radiation, called FLASH. By making good use of the self-amplified spontaneous emission (SASE) principle, DESY has contributed to the progress of free electron laser technology by achieving an extreme peak brilliance of coherent beams and providing X-ray pulses in the femtosecond regime. FLASH, the user operation of which was launched in summer 2005, currently covers wavelengths from 13 nm to 50 nm with gigawatt peak power and pulse durations between 10 and 50 fs. Approximately 20 weeks of user beam time are provided per year to four beamlines.

The future free electron laser for the X-ray range (XFEL) being planned at DESY in collaboration with European partners will produce coherent X-ray beams of extremely intense, ultra-short X-ray pulses with unprecedented brilliance. According to present plans, the commissioning of such a facility could start in 2013 after a six year construction period.

III.1.5. DIAMOND, UK

<http://www.diamond.ac.uk/>

The DIAMOND light source, a UK funded, 3 GeV third-generation synchrotron radiation source situated in South Oxfordshire, welcomed its first scientific users in January 2007. Designed to host up to 40 experimental stations, the use of DIAMOND will be shared between physical sciences (~50%), life sciences (~40%) and environmental sciences (~10%). To support this programme, the beamlines will be grouped in villages featuring macromolecular crystallography, soft condensed matter, spectroscopy, engineering and environmental science, materials, and surfaces and interfaces (nanosciences).

DIAMOND started operation with seven phase one beamlines at the beginning of 2007. These are distributed as follows:

- Three dedicated to macromolecular crystallography,
- A microfocus soft X-ray beamline with variable polarisation (linear and circular) with photo-emission electron microscopy capabilities on the nanometre and picosecond scale for nanosciences,
- A high-energy beamline for studies of samples under extreme conditions (high T , p),
- A high-resolution X-ray scattering and diffraction beamline to study electronic, magnetic and mechanical properties of advanced materials and
- A microfocus X-ray absorption spectroscopy beamline to study complex materials under realistic conditions.

During 2007, the eighth beamline, and the first of DIAMOND's phase two programme, will begin to study the structure and dynamics of large molecular assemblies in low-ordered environments on a length scale between 1 and 1000 nm by non-crystalline diffraction.

During 2008, the beamline portfolio will be complemented by a beamline dedicated to the study, using high-resolution powder diffraction, of complex materials such as high T_c superconductors, ceramics, alloys, etc., as well as a beamline for structural investigations into small molecules using single crystal diffraction in standard and timing modes. The life sciences will be served by a further beamline for macromolecular crystallography with microfocus capabilities and a bending magnet life sciences and chemistry beamline to obtain structural, functional and dynamic information on proteins, nucleic acids and chiral molecules.

Phase two will continue until 2011 with, amongst others, an infrared beamline with sub-micrometre resolution in the mid-infrared region; a coherent imaging beamline to image materials down to the 20 nm range, with an ultra-high resolution small angle

scattering branch, a beamline specifically designed for engineering research looking at materials under exacting conditions typical of industrial processes; and an advanced beamline on dichroism experiments together with two further beamlines on surface and interface structure analysis, which will strengthen the nanosciences programme at DIAMOND.

III.1.6. ELETTRA, Italy

<http://www.elettra.trieste.it/>

The Italian synchrotron facility, ELETTRA, is managed by a non-profit share company, the main shareholders of which are local authorities, national research institutions and industrial partners. The third-generation ELETTRA storage ring, optimised for the VUV and soft X-ray regime, is operated at 2.0/2.4 GeV. Since the first experiments carried out in 1993, ELETTRA has constantly been upgraded, reaching more than 20 operating beamlines in the range of a few electronvolts to tens of kiloelectronvolts.

The beamline portfolio consists of a large number of stations dedicated to soft X-ray photoemission studies of all kinds. Amongst them are facilities enabling imaging photo-emission electron microscopy with below 40 nm lateral resolution, and with variable polarisation, as well as a beamline to investigate the properties of gaseous samples.

An X-ray microscope combining scanning and full field imaging is dedicated to advanced studies in biology, medicine, geochemistry and environmental sciences, while two lithography beamlines are installed for the production of structures at the micro and nano levels.

Life sciences are served by a beamline dedicated to macromolecular crystallography and a medical beamline for the research into diagnostic radiology and imaging. A unique beamline for inelastic scattering in the VUV region, and two infrared stations for imaging and spectroscopy, round off ELETTRA's beamline portfolio.

To add to the synchrotron radiation activities, the construction of a single-pass free electron laser is being studied, which will cover the 12 to 124 eV energy range. The project will make use of the existing 1.2 GeV linear accelerator and have two undulator chains, each feeding multiple experimental stations.

III.1.7. MAXLAB, Sweden

<http://www.maxlab.lu.se/>

MAX-lab is a Swedish national laboratory which supports three distinct areas of research: accelerator physics, studies based on the use of synchrotron radiation, and nuclear physics using energetic electrons.

Two storage rings are currently operational:

- MAX-III, a 700 MeV storage ring for research in the VUV range, and
- MAX-II, a 1.5 GeV third-generation storage ring, commissioned between 1994 and 1996. It is dedicated to UV and (soft) X-ray experiments carried out on 14 beamlines offering experimental stations for X-ray photo electron spectroscopy, X-ray absorption spectroscopy, X-ray emission spectroscopy, small angle scattering, polarisation-dependent studies, macromolecular crystallography and nano/deep X-ray lithography. Five of the experimental stations (an EXAFS station and the macromolecular crystallography facilities) receive their radiation from superconducting wigglers, allowing operation up to 20 keV.

In 2006, the conceptual design report for a next generation, Swedish synchrotron radiation facility (MAX-IV) was published, consisting of a 3 GeV storage ring for the hard X-ray region and a 1.5 GeV ring to cover the VUV regime. This proposal was favourably reviewed by the Swedish Research Council.

III.1.8. SLS, Switzerland

<http://sls.web.psi.ch/>

The Swiss Light Source (SLS), a third-generation, 2.4 GeV national synchrotron radiation facility at the Paul Scherrer Institut, began operation in August 2001. Situated near Villigen, about 40 km north-west of Zürich, the storage ring offers a mixture of straight sections of various lengths, allowing for adapted insertion devices, most of them undulators with flexible polarisation schemes. Since the storage ring is operated with top-up injection, a constant incoming flux is delivered to the ten beamlines, which are open to national and international user groups from academia and industry. Three of the central bending magnets are replaced by 2.9 T superbends. With about twice the field of the normal magnets, their critical energy is 11.1 keV, thus allowing for better access to X-rays above 20 keV.

Within this portfolio of operational beamlines are two soft X-ray beamlines (SIS, SIM) dedicated to the study of the atomic and electronic structure of

surfaces and interfaces by providing photo-emission spectroscopy, photo electron diffraction, X-ray emission, X-ray magnetic circular dichroism and photo-emission electron microscope techniques. A further soft X-ray beamline allows for scanning transmission X-ray microspectroscopy (POLLUX).

The hard X-ray regime (up to 45 keV) is served at SLS by a beamline dedicated to tomographic microscopy and coherent radiology (TOMCAT), and a wiggler beamline (MS) dedicated to materials science research using *in situ* surface diffraction and powder diffraction techniques.

There are two XAS undulator beamlines, with a third one under construction (2007) at a superbend. The first, MicroXAS, covers the energy range from 4.5 to 20 keV for X-ray absorption and fluorescence experiments requiring high spatial resolution. This beamline also hosts the FEMTO project, enabling the investigation of phenomena in the femtosecond time regime. LUCIA, the other XAS beamline, covers the 0.8 to 7 keV energy range. This is a joint project operated by the SLS and SOLEIL, and will be moved to SOLEIL in 2008. The slot thus vacated will be shared by an improved version of LUCIA for microspectroscopy at medium energies, and a second branch, X-Treme, for the study of X-ray magnetic dichroism at low temperatures and high magnetic fields. Two insertion device beamlines for macromolecular crystallography, one of them restricted to partner institutes, complement the list of experimental stations.

In addition to their active user programme, SLS is strongly engaged in the development of instrumentation, especially the 3D Pilatus pixel detector, the 1D Mythen micro-strip detector, the APD array for photo-correlation spectroscopy, and X-ray beam position monitors based on CVD-diamond technology.

In the first part of 2007, a beamline for infrared spectroscopy will start operation, as well as two others:

- ADDRESS, a soft X-ray beamline providing circular and 0-180° variable linear polarisation for resonant X-ray scattering experiments, and
- cSAXS, a beamline for coherent small-angle X-ray scattering.

In the near future, the SLS will expand its capacity by constructing a beamline for spectroscopy in the VUV energy region (bending magnet) and a third macromolecular crystallography beamline (superbend) with the addition of a crystallisation facility.

III.1.9. SOLEIL, France

<http://www.synchrotron-soleil.fr/>

The newly constructed French synchrotron radiation facility, SOLEIL, a third-generation storage ring of 2.75 GeV, achieved its first stored electrons in May 2006 after a three year construction phase. In March 2007, the ring was being operated with a 300 mA current. Twelve beamlines are in their commissioning phase and will be opened to users in the second half of 2007, the aim being to reach the final number of 24 beamlines by 2009. The first experimental results (X-ray absorption spectroscopy to determine the local environment of heavy elements in kidney stones) have already been reported (March 2007, via www.lightsources.org).

SOLEIL's beamline portfolio will cover the photon energies from the infrared up to medium energy X-rays of around 20 keV, with about half of the beamlines using photons below 2 keV, and with spot sizes down to below 10 µm in most of the beamlines. All of the major methods of analysis in use at modern synchrotron facilities will be offered at SOLEIL: structural information by diffraction, scattering and reflectivity methods; information on the chemical composition and properties of samples by infrared, ultraviolet and X-ray spectroscopic techniques. Information on the morphology of samples will be obtained by infrared, VUV and X-ray imaging and radiography, involving six beamlines. The electronic and magnetic structure of samples from bulk materials to surfaces, thin films and interfaces will be studied by X-ray absorption and inelastic scattering methods, with photoemission and polarisation-dependent techniques applied at eight beamlines.

In addition to this wide user programme, a transverse experimental programme on cultural heritage and archaeology (HALO) has been setup at SOLEIL. It will share many of the beamlines available, especially 2D microimaging and microtomography methods together with XAS and XD. A dedicated laboratory, IPANEMA, will be established to serve as an interface between SOLEIL and the cultural heritage and archaeology communities.

To complement these experimental efforts, a new institute run by the Paris-Sud University and by the CNRS will also be implemented in close connection with SOLEIL. This "Institut de Pharmacologie moléculaire et structural" will develop its own research programme but will also be an interface between the pharmaceutical and biological communities and SOLEIL.

III.2. Worldwide sources comparable to the ESRF

III.2.1. APS, United States of America

<http://www.aps.anl.gov/>

Located at the Argonne National Laboratory near Chicago, USA, the Advanced Photon Source (APS) has operated a third-generation storage ring at 7 GeV since 1995. The ring lattice allows up to 35 sectors, each hosting an insertion device and a bending magnet beamline. Roughly one-half of the beamlines currently operational were constructed, and are operated, by so-called collaborative access teams (CAT), with backgrounds ranging from academia to industry. The remaining beamlines are run by the APS X-ray Operation and Research Group (XOR). All XOR and most CAT beamlines accept applications for beam time from outside users.

The large number of some 60 experimental stations covers all facets of synchrotron radiation-based (hard) X-ray research in physics, chemistry, materials and life sciences, as well as industrial applications, a vast variety of experimental techniques being on offer.

In 2004, after nearly ten years of user operation, APS launched an intense discussion with its users on the facility's scientific future. A series of nine workshops identified the main scientific opportunities for synchrotron radiation: picosecond pulse generation, long beamlines for full field imaging, a bio nanoprobe facility, high magnetic fields, and improved detectors. The refurbishment of existing beamlines, as well as the construction of new ones, is oriented in line with these recommendations.

Two general options have been identified for possible upgrade of the storage ring:

- i) an upgrade of the storage ring lattice using the existing tunnel that allows for picosecond pulses, longer straight sections, lower emittance, and improved coherence and beam stability;
- ii) an upgrade of the APS to an energy recovery linac (ERL) to be attached to the existing storage ring, promising revolutionary performance improvements in the aforementioned areas while retaining compatibility with existing beamlines and enabling an upgrade path without extended disruption of user operations.

A Machine Advisory Committee was created to review the two options, and has expressed an opinion clearly in favour of the ERL approach. A white paper on the research and development needed to develop this, and other possible options, is being drawn up.

III.2.2. SPRING-8, Japan

<http://www.spring8.or.jp/>

Situated near Kobe in the Harima Science Garden City, the Japanese synchrotron facility SPRING-8, which operates at 8 GeV, is the world's largest third-generation source of synchrotron radiation. The construction was undertaken jointly from 1991 by the Japan Atomic Energy Research Institute (JAERI) and the Institute of Physical and Chemical Research (RIKEN). The storage ring can host up to 38 insertion device beamlines (four of them on 25 m long straight sections) as well as 24 beamlines on dipole magnets with a critical energy of 29 keV. Since user operation began in 1997, the Japan Synchrotron Radiation Research Institute (JASRI) has been responsible for the operation, proposal selection, and utilisation of the facility.

The SPRING-8 users (domestic and international) are supported by the Research and Utilisation Division and the Industrial Application Division of JASRI. They run 25 public beamlines and some 50 experimental stations, fostering research in various sciences: life, materials, earth, environmental and engineering, as well as performing technological studies in electronics, chemistry, medical science and biology. To meet the demand of a growing user community, the Research and Utilisation Division is organised into subgroups on materials structures (three subgroups), spectroscopy (two subgroups), structural biology, imaging, and pinpoint structure measurement.

RIKEN at SPRING-8 is now taking part in the race for the first X-ray free electron laser (XFEL). In 2006, the electrons generated and accelerated by a prototype accelerator for a future XFEL lased successfully. Laser light of 49 nm wavelength with some 110 kW output power was produced with a newly developed electron gun and a highly efficient accelerator. The envisaged XFEL facility could be completed in 2010.



The European Light Source

ESRF SCIENCE AND TECHNOLOGY PROGRAMME 2008-2017

ANNEXE IV

ESRF Facts and Figures

ESRF Facts and Figures

The European Synchrotron Radiation Facility (ESRF) is Europe's international centre for synchrotron radiation based X-ray research. Its activities are supported by 17 European countries and Israel (twelve Member states and six Associates). The ESRF is organised as a French *société civile*.

Members' contributions to the annual budget:

| | |
|-------|--|
| 27.5% | France |
| 25.5% | Germany |
| 15% | Italy |
| 14% | United Kingdom |
| 4% | Spain |
| 4% | Switzerland |
| 6% | Benesync (Belgium, The Netherlands) |
| 4% | Nordsync (Denmark, Finland, Norway, Sweden) |

Associate's contributions (percentages refer to Members' total contribution):

| | |
|-------|----------------|
| 1% | Portugal |
| 1% | Israel |
| 1% | Austria |
| 1% | Poland |
| 0.47% | Czech Republic |
| 0.2% | Hungary |



IV.1. ESRF annual budget

The annual income of the ESRF currently (figures for the year 2006) amounts to around 80 million euro (M€):

| | |
|--|----------------|
| Members' contributions: | 68.5 M€ |
| Associates' contributions: | 3.8 M€ |
| Other income (beam time sales, licences, EU projects, etc.): | 6.0 M€ |
| Total | 78.3 M€ |

of which roughly 13% is spent on the accelerators and the source, 48% on beamlines, experiments and in-house research, and 39% on technical and administrative support.

IV.2. Staff

The ESRF has about 580 staff from 30 countries, with some 60% of French nationality. There are ~290 engineers and scientists including ~40 postdoctoral fellows, ~185 technical staff, ~30 PhD thesis students, and ~75 administrative staff. In addition, about 20 scientific staff are externally funded (*e.g.* by the EC).

IV.3. The beamlines

The ESRF operates 31 public beamlines, most of them using insertion devices (undulator/wiggler) light sources. These beamlines are listed in [Table IV.3.1](#). Some beamlines are not 100% available to the ESRF public user system (beamlines ID06, BM05) whilst other beamlines have more than one experimental station (*e.g.* ID14A, ID14B).

In addition to these public ESRF beamlines, external organisations, the Collaborating Research Groups (CRG), operate 11 bending magnet-based beamlines mainly for national communities ([Table IV.3.2](#)). One-third of the beam time at CRG beamlines is available to the ESRF public user programme, the remaining two-thirds serves the CRG's own scientific communities.

[Figure IV.3.1](#) shows the location of the beamlines in the Experimental Hall.

| Source position | Number of independent end-stations | Beamline name | Status |
|-----------------|------------------------------------|--|-------------------------|
| ID01 | 1 | Anomalous scattering | Operational since 07/97 |
| ID02 | 1 | High brilliance | Operational since 09/94 |
| ID03 | 1 | Surface diffraction | Operational since 09/94 |
| ID06 | 1 | Instrumentation development | Operational in 2007 |
| ID08 | 1 | Dragon | Operational since 02/00 |
| ID09 | 1 | White beam | Operational since 09/94 |
| ID10A | 1 | Troika I + III | Operational since 09/94 |
| ID10B | 1 | Troika II | Operational since 04/98 |
| ID11 | 1 | Materials science | Operational since 09/94 |
| ID12 | 1 | Circular polarisation | Operational since 01/95 |
| ID13 | 1 | Microfocus | Operational since 09/94 |
| ID14A | 2 | Protein crystallography EH 1 | Operational since 07/99 |
| | | Protein crystallography EH 2 | Operational since 12/97 |
| ID14B | 2 | Protein crystallography EH 3 | Operational since 12/98 |
| | | Protein crystallography EH 4 | Operational since 07/99 |
| ID15A | 1 | High energy diffraction | Operational since 09/94 |
| ID15B | 1/2 | High energy inelastic scattering | Operational since 09/94 |
| ID16 | 1 | Inelastic scattering I | Operational since 09/95 |
| ID17 | 1 | Medical | Operational since 05/97 |
| ID18 | 1 | Nuclear scattering | Operational since 01/96 |
| ID19 | 1 | Topography | Operational since 06/96 |
| ID20 | 1 | Magnetic scattering | Operational since 05/96 |
| ID21 | 2 | X-ray microscopy (soft X-rays and infra-red) | Operational since 12/97 |
| ID22 | 1 | Microfluorescence | Operational since 12/97 |
| ID23 | 2 | Macromolecular crystallography MAD | Operational since 06/04 |
| | | Macromolecular crystallography microfocus | Operational since 09/05 |
| ID24 | 1 | Dispersive EXAFS | Operational since 02/96 |
| ID26 | 1 | X-ray absorption and emission | Operational since 11/97 |
| ID27 | 1 | High pressure | Operational since 02/05 |
| ID28 | 1 | Inelastic scattering II | Operational since 12/98 |
| ID29 | 1 | Multiwavelength anomalous diffraction | Operational since 01/00 |
| ID30 | 1 | Machine division beamline | Operational in 2007 |
| ID31 | 1 | Powder diffraction | Operational since 05/96 |
| ID32 | 1 | X-ray standing wave and surface diffraction | Operational since 11/95 |
| BM05 | 1 | Optics - Open Bending Magnet | Operational since 09/95 |
| BM29 | 1 | X-ray absorption spectroscopy | Operational since 12/95 |

Table IV.3.1: List of the current public ESRF beamlines in operation and under construction.

| Source position | Number of independent end-stations | Beamline name | Field of research | Status |
|-----------------|------------------------------------|------------------------|--|-------------------------|
| BM01 | 2 | Swiss-Norwegian BL | X-ray absorption & diffraction | Operational since 01/95 |
| BM02 | 1 | D2AM (French) | Materials science | Operational since 09/94 |
| BM07 | 1 | GRAAL (Italian/French) | Gamma ray spectroscopy | Operational since 06/95 |
| BM08 | 1 | Gilda (Italian) | X-ray absorption & diffraction | Operational since 09/94 |
| BM14 | 1 | UK CRG | Macromolecular crystallography (MAD) | Operational since 01/01 |
| BM16 | 1 | SPANISH CRG | Structural biology (MAD, SAX) | Operational since 01/03 |
| BM20 | 1 | ROBL (German) | Radiochemistry & ion beam physics | Operational since 09/98 |
| BM25 | 2 | SPLINE (Spanish) | X-ray absorption & diffraction | Operational since 04/05 |
| BM26 | 2 | DUBBLE (Dutch/Belgian) | Small-angle scatt. & interface diffraction | Operational since 12/98 |
| | | | Protein crystallography + EXAFS | Operational since 06/01 |
| BM28 | 1 | XMAS (British) | Magnetic scattering | Operational since 04/98 |
| BM30 | 2 | FIP (French) | Protein crystallography | Operational since 02/99 |
| | | FAME (French) | EXAFS | Operational since 08/02 |
| BM32 | 1 | IF (French) | Interfaces | Operational since 09/94 |

Table IV.3.2: List of the current Collaborating Research Group beamlines in operation.

IV.4. User operation

Figure IV.4.1 illustrates the increase in the number of applications for beam time since 2000, and shows that, although the main beamline construction effort was complete by 1999, the number of applications for beam time continues to increase steadily. This increase together with the associated increase in user visits, reflects the continued attractiveness of the ESRF for Europe's scientists.

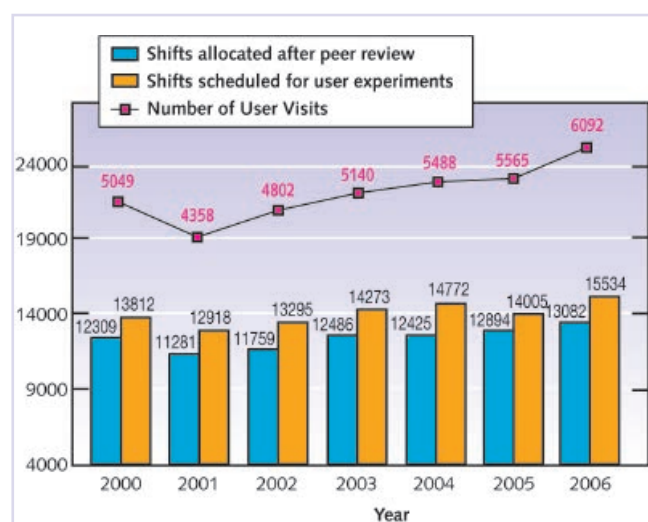

Figure IV.4.1: Numbers of applications for beam time, experimental sessions and user visits, 2000 to 2006.

Proposals for experiments are selected and beam time allocations are made through a peer review system. Review Committees of specialist scientists, mainly from European countries and Israel, have been set up in the following scientific areas:

- Applied materials and engineering
- Chemistry
- Crystals and ordered systems
- Disordered systems and liquids
- Electronic and magnetic properties
- Environmental and cultural heritage matters
- Macromolecular crystallography
- Medicine
- Methods and instrumentation
- Soft condensed matter
- Surfaces and interfaces.

| Filling pattern | Uniform | Hybrid | 16-bunch | 4-bunch |
|-----------------------|---------|---------|----------|---------|
| Number of bunches | 992 | 24x8 +1 | 16 | 4 |
| Maximum current [mA] | 200 | 200 | 90 | 40 |
| Lifetime [h] | 75 | 30 | 11 | 6 |
| Rms energy spread [%] | 0.11 | 0.11 | 0.12 | 0.16 |
| Rms bunch length [ps] | 20 | 25 | 48 | 55 |

Table IV.5.2

The number of Review Committees has evolved since the ESRF came into operation following the growing and widening application of synchrotron light. The Committees meet twice during the year, six weeks after the deadlines for submission of proposals (1 March and 1 September). They review the increasing number of applications for beam time: 1892 for the year 2006, of which 828 (43.8%) were selected to be carried out. A procedure to handle Long Term Proposals (LTP) has been established for projects requiring access to beam time for a longer period. LTP are reserved for projects of benefit to both the ESRF and the user community.

Overall, the number of users in each experimental team averages 4.2 persons, who on average stay for some four days. The ESRF normally pays travel and local expenses for up to three scientists per scheduled public experiment. Users responding to questionnaires indicate that they particularly appreciate the assistance received from scientists and support staff on beamlines, and the smooth administrative arrangements, in addition to the quality both of the beam and of the experimental stations. Facilities on site, such as laboratories for sample preparation and characterisation, the guesthouse and a canteen open seven days a week also make an important contribution to the quality of user support.

IV.5. The source

Table IV.5.1 presents a summary of the main characteristics of the storage ring's electron beam.

| | | |
|---------------------------------------|-------|--------------|
| Energy | [GeV] | 6.03 |
| Maximum current | [mA] | 200 |
| Horizontal emittance | [nm] | 4 |
| Vertical emittance (minimum achieved) | [nm] | 0.03 |
| Revolution frequency | [kHz] | 355 |
| Number of bunches | | 1 to 992 |
| Time between bunches | [ns] | 2816 to 2.82 |

Table IV.5.1

Different filling patterns are routinely delivered to serve experiments requiring the highest flux or brightness as well as those requesting a special time structure of the X-rays. Table IV.5.2 lists a few representative filling patterns available.



The European Light Source

ESRF SCIENCE AND TECHNOLOGY PROGRAMME 2008-2017

Glossary and Contributors

Glossary

Conceptual Design Report Acronyms

| | |
|----------------------------|--|
| CDI | Coherent X-ray Diffraction Imaging and Microdiffraction |
| CPR | Development of Clinical Protocols in Radiotherapy |
| DICHRO | Polarisation Dependent X-ray Spectroscopy |
| EDXAS-L | Energy Dispersive Absorption Spectroscopy (large spot) |
| EDXAS-S | Energy Dispersive Absorption Spectroscopy (small spot) |
| EMS | Engineering Materials Science |
| EXAFS | Extended X-ray Absorption Fine Structure Spectroscopy |
| GISD | Grazing Incidence Scattering and Diffraction |
| HIENE | High Energy X-ray Beamline |
| HIPRE | High Pressure Technique Beamlines |
| HISAXS | High Throughput Small Angle X-ray Scattering |
| HXPM | Hard X-ray Photoelectron Microscopy |
| IMPACT | Imaging using Parallel Beam and Computed Tomography |
| INELX | Inelastic X-ray Scattering |
| MAGSCAT | Magnetic Scattering |
| MASSIF | Massively Automated Sample Screening Integrated Facility |
| MATSCI | Materials Science |
| MINADIF | Micro- and Nano-Diffraction |
| MX-BIB | Biological Imaging Beamline |
| MX-MAD1 / MX-MICROFOCUS | Macromolecular Crystallography using Multi-Wavelength Anomalous Dispersion and Microfocus |
| MX-MAD2 | Macromolecular Crystallography using Multi-Wavelength Anomalous Dispersion with Microfocus |
| NR-HE | Nuclear Resonance - High Energy |
| NR-NSM | Nuclear Resonance - Nanoscale Materials |
| OPTICS | Facility for Surfacing Mirror Substrates |
| PHIXS | Phonon Inelastic X-ray Spectroscopy |
| PMF | Pulsed Magnetic Fields |
| POW | High Resolution Powder Diffraction |
| RIXS-PES | High Resolution Resonant Inelastic X-ray Scattering and Photoelectron Spectroscopy |
| SAXS | Small Angle X-ray Scattering |
| SFINX | Scanning Fluorescence and Imaging at the Nanoscale using X-rays |
| SMILE | Spectro-Microscopy and Imaging at Low Energies |
| SMS | Resonant Soft X-ray Magnetic Scattering |
| SURF | Surface Diffraction |
| TIBIDI | Technical Beamline for Instrumentation Development |
| TRD | Time-Resolved Diffraction and Pump-and-Probe |
| WIBIDI | White Beam Technical Development Beamline |
| XAS-XES | Steady-State and Time-Resolved X-ray Absorption and Emission Spectroscopy |
| XMAN | X-ray Spectroscopy Multi-Imaging Analysis |
| XPCS-CXS | X-ray Photon Correlation Spectroscopy and Coherent X-ray Scattering |

Other Abbreviations

| | |
|--------|--|
| μXRF | μX-ray Fluorescence |
| 3DXRD | Three Dimensional X-ray Diffraction |
| ABI | Analyser Based Imaging |
| AD | Anomalous Dispersion |
| AFM | Atomic Force Microscopy |
| APD | Avalanche Photo Diode |
| ARPES | Angle Resolved Photoemission Spectroscopy |
| ASAXS | Anomalous Small Angle X-ray Scattering |
| ATEM | Analytical Transmission Electron Microscopy |
| AXRD | Anomalous X-ray Diffraction |
| BBB | Blood Brain Barrier |
| BMF | Bio-Medical Facility |
| BPM | Beam Position Monitor |
| CBV | Cerebral Blood Volume |
| CCD | Charge Coupled Device |
| CDI | Coherent Diffraction Imaging |
| CDR | Conceptual Design Report |
| CISB | Centre for Integrated Structural Biology |
| CMOS | Complementary Metal Oxide Semiconductor |
| CMR | Colossal Magneto Resistance |
| COD | Computing On Demand |
| CPU | Central Processing Unit |
| CRG | Collaborating Research Group |
| CRL | Compound Refractive Lenses |
| CT | Computer Tomography |
| CVD | Chemical Vapour Deposition |
| CW | Continuous Wave |
| CXDI | Coherent X-ray Diffraction Imaging |
| DAC | Diamond Anvil Cell |
| DAFS | Diffraction Anomalous Fine Structure |
| DBA | Double Bend Achromat |
| DEPFET | Depleted P-channel Field Effect Transistor |
| DLS | Dynamic Light Scattering |
| DOS | Density Of States |
| EDXAS | Energy Dispersive X-ray Absorption Spectroscopy |
| EGEE | Enabling Grids for E-Science project |
| EPR | Electron Paramagnetic Resonance |
| ERL | Energy Recover Linacs |
| ESCA | Electron Spectroscopy for Chemical Analysis |
| EXAFS | Extended X-ray Absorption Fine Structure |
| FABLE | Framework for Automating Beamlines and Experiments |
| FEL | Free Electron Laser |
| FEM | Finite Element Method |
| FIB | Focused Ion Beam |
| FTIR | Fourier Transform Infrared |
| FWHM | Full Width Half Maximum |
| GID | Grazing Incidence Diffraction |

| | |
|-----------|---|
| GINRS | Grazing Incidence Nuclear Resonance Scattering |
| GIS | Grazing Incidence Diffuse Scattering |
| GISAXS | Grazing Incidence Small Angle X-ray Scattering |
| GIWAXS | Grazing Incidence Wide Angle Scattering |
| GOS | Global Ocean Survey |
| GSI | Grid Security Infrastructure |
| HAXPES | Hard X-ray Photoelectron Spectroscopy |
| HERCULES | Higher European Research Course for Users of Large Experimental Systems |
| HERFD | High Energy Resolution Fluorescence Detected |
| HRM | High Resolution Monochromators |
| HOM | High Order Mode |
| HPPC | High Performance Parallel Computing |
| HXPS | Hard X-ray Photoelectron Spectroscopy |
| HXRD | High Resolution X-ray Diffraction |
| I/O | Input/Output |
| INS | Inelastic Neutron Scattering |
| IOT | Inductive Output Tubes |
| IR | Infra Red |
| IXS | Inelastic X-ray Scattering |
| KB | Kirkpatrick-Baez |
| LCG | Large-Hadron Collider Computing Grid |
| LEED | Low Energy Electron Diffraction |
| LMF | Lamb-Mössbauer Factors |
| LRMO | Long Range Magnetic Order |
| LSF | Load Sharing Facility |
| LVP | Large Volume Press |
| MAD | Multi-Wavelength Anomalous Dispersion |
| MBE | Molecular Beam Epitaxy |
| MCS | Magnetic Compton Scattering |
| MEMS | Micro Electro Mechanical System |
| ML | Multilayer |
| MLL | Multilayer Laue Lenses |
| MOF | Metal Organic Framework |
| MOKE | Magneto Optical Kerr Effect |
| MRT | Microbeam Radiation Therapy |
| MS&E | Materials Science and Engineering |
| MX | Macromolecular Crystallography |
| Nano-SIMS | Nano-Secondary Ion Mass Spectrometry |
| NAPP | Near Ambient Pressure Photoemission |
| NEG | Non Evaporable Getter |
| NEMS | Nano-ElectroMechanical System |
| NFL | NanoFocusing Lenses |
| NFS | Nuclear Forward Scattering |
| NFXS | Near-Field X-ray Scattering |
| NIS | Nuclear Inelastic Scattering |
| NMR | Nuclear Magnetic Resonance |
| NRFS | Nuclear Resonant Forward Scattering |
| NRIXS | Non-Resonant Inelastic X-ray Scattering |
| NRS | Nuclear Resonance Scattering |

| | |
|-----------|---|
| NRXMS | Non-Resonant X-ray Magnetic Scattering |
| PASS | PAtient Safety System |
| PB | PetaByte = 1×2^{50} Bytes |
| PBS | Portable Batch System |
| PDB | Protein Data Bank |
| PDF | Pair Distribution Function |
| PEEM | Photoemission Microscopy |
| POI | Point Of Interest |
| PSD | Position Sensitive Director |
| R&D | Research and Development |
| RC | Reaction Centre |
| RF | Radio Frequency |
| RGA | Residual Gas Analysis |
| RHEED | Reflection High Energy Electron Diffraction |
| RIXS | Resonant Inelastic X-ray Scattering |
| RNA | Ribonucleic Acid |
| RSXS | Resonant Soft X-ray Scattering |
| RT | Radiation Therapy |
| RXS | Resonant X-ray Scattering |
| S/N ratio | Signal/Noise Ratio |
| SAD | Single-Wavelength Anomalous Dispersion |
| SAXS | Small Angle X-ray Scattering |
| SC | Superconducting Cavities |
| SCES | Strongly Correlated Electron Systems |
| SCHM | Series Connected Hybrid Magnet |
| SCM | Soft Condensed Matter |
| SDD | Silicon Drift Diode |
| SEM | Scanning Electron Microscopy |
| SEXAFS | Surface Extended X-ray Absorption Fine Structure |
| SHADOW | General purpose ray tracing software |
| SMIS | Scientific Management Information System |
| SPM | Scanning Probe Microscopes |
| SRCT | Synchrotron Radiation Computed Tomography |
| SRPAC | Synchrotron Radiation based Perturbed Angular Correlation |
| SSCM | Superconducting Split Coil Magnets |
| SSRT | Stereotactic Synchrotron Radiation Therapy |
| STM | Scanning Tunnelling Microscopy |
| SWASER | Spin Wave Amplification by Stimulated Emission of Radiation |
| SXRD | Surface X-ray Diffraction |
| TACO | Telescope and Accelerator Controls Objects |
| TANGO | Taco Next Generation Objects |
| TB | TeraByte = 1×2^{40} Bytes |
| TBA | Triple Bend Achromat |
| TDR | Technical Design Report |
| TDS | Thermal Diffuse Scattering |
| TEM | Transmission Electron Microscopy |
| TXRF | Total Reflection X-ray Fluorescence |
| UHV | Ultra High Vacuum |
| UI | User Interface |

| | |
|-------------|--|
| UPS | Uninterruptible Power Supply |
| USAXS | Ultra Small Angle X-ray Scattering |
| USM | User Service Mode (Operation Time) |
| UV | Ultra-Violet |
| UV-Vis | UltraViolet-Visible light |
| VDOS | Vibrational Density Of States |
| VLS | Variable Line Spacing |
| VO | Virtual Organisations |
| VUV | Vacuum Ultra Violet |
| WAXS | Wide Angle X-ray Scattering |
| XANES | X-ray Absorption Near Edge Structure |
| XAS | X-ray Absorption Spectroscopy |
| XDMR | X-ray Detected Magnetic Resonance |
| XEOL | X-ray Excited Optical Luminescence |
| XES | X-ray Emission Spectroscopy |
| XFEL | X-ray Free Electron Laser |
| XFS | X-ray Fluorescent Spectroscopy |
| XM χ D | X-ray Magneto-chiral Dichroism |
| XMCD | X-ray Magnetic Circular Dichroism |
| XMLD | X-ray Magnetic Linear Dichroism |
| XML | Extended Markup Language |
| XMS | X-ray Magnetic Scattering |
| XnrLD | non-reciprocal X-ray Linear Dichroism |
| XOA | X-ray Optical Activity |
| XOP | X-ray Oriented Programmes software package |
| XPCS | X-ray Photon Correlation Spectroscopy |
| XPEEM | X-ray PhotoEmission Electron Microscope |
| XRD | X-ray Diffraction |
| XRF | X-ray Fluorescence |
| XRI | X-ray Imaging |
| XRR | X-ray Reflectivity |
| XRS | X-ray Scattering |
| XSW | X-ray Standing Wave |
| ZP | Zone Plate |

Notes

List of Contributors

R Abela, G Admans, J Als-Nielsen, D Andrault, G Aquilanti, M Baldwin, R Barrett, J Baruchel, AL Benabid, R Berjon, P Berkvens, P Bernard, JC Biasci, S Blanchon, N Bolfan, G Bomchil, M Bolognesi, J Borrel, D Bourgeois, JF Bouteille, L Braicovich, A Bravin, N Brookes, E Bruas, JY Buffière, T Buslaps, JL Carrascosa, JM Chaize, J Chavanne, M Chergui, A Chumakov, P Cloetens, F Comin, M Cotte, W Crichton, Y Dabin, J Daillant, C Dallera, I Daniel, WH De Jeu, S De Panfilis, JC Deshayes, M Di Michiel, R Dimper, H Dosch, L Dubrovinsky, S Eeckhout, A El Ghazouani, P Elleaume, L Eybert Bérard, P Fajardo, L Farvacque, R Feidenbans'l, R Felici, C Ferrero, G Fiquet, A Fitch, D Flot, P Fornasini, E Gagliadini, G Gbiringbelli, P Glatzel, A Götz, J Goulon, M Grunze, G Guilera, M Habn, D Hall, N Hall, K Hamalainen, M Hanfland, L Hardy, JB Hastings, V Honkimaki, W Hunter, S Huotari, R Kersevan, J Jacob, K Janssens, A Kaprolat, WD Klotz, F Koch, JM Koch, O Konovalov, AM Korsunsky, H Kreh, M Krisch, Å Kvick, S Larsen, G Le Duc, B Lebayle, G Leonard, P Mackrill, A Madsen, T Mairs, P Marion, K Martel, O Mathon, M Mattenet, C Mazzoli, A McCarthy, J McCarthy, S McSweeney, T Metzger, M Mezouar, G Monaco, C Morawe, J Morse, C Mueller-Dieckmann, T Narayanan, C Nave, G Naylor, A Nencioni, M Newton, D Nurizzo, L Paolasini, S Pascarelli, W Paulus, P Pernot, L Petit, C Petrillo, JL Plantier, E Plouviez, D Pontoni, I Popa, HF Poulsen, C Prestipino, R Ravelli, M Renier, V Rey-Bakaikoa, C Riekel, M Rodriguez Castellano, A Rogalev, A Ropert, M Rossat, G Rossi, R Rüffer, T Salditt, A Santin, K Scheidt, C Schroer, F Sette, M Sikora, WG Stirling, C Stuck, G Sulzenbacher, J Susini, A Tadjeddine, P Tafforeau, P Theveneau, P Thiry, R Tucoulou, M Vaccari, P van der Linden, P van Vaerenbergh, G Vaughan, L Vincze, E Vlieg, G Vogl, E Weckert, TC Weng, D Wermeille, F Wilhelm, K Wilson, C Woodham, P Woodruff, J Wright, M Wulff, J Zegenbagen, E Ziegler, F Zontone.

The contribution of the people named above was only possible thanks to generous support and goodwill from all ESRF staff.

*Editors: T Bouvet, C Detlefs, E Mitchell, JL Revol
September 2007*

Terms and Conditions (PDF version)

Typesetting:
Pixel Project
Cover design:
Spaced Design Ltd
Printing:
Imprimerie du Pont de Claix

Readers may view, browse, and/or download material for temporary copying purposes only, provided these uses are for noncommercial personal purposes. Except as provided by law, this material may not be further reproduced, distributed, transmitted, modified, adapted, performed, displayed, published, or sold in whole or in part, without prior written permission from the publisher.

ESRF

BP 220, 38043 Grenoble, France

Tel. (33) 4 76 88 20 00 - Fax. (33) 4 76 88 20 20

This publication may be downloaded from the website: <http://www.esrf.eu>